

MC-12 *Controller EQ*

User Guide



3 Oak Park
Bedford, MA 01730-1413 USA
Tel 781-280-0300
Fax 781-280-0490
www.lexicon.com

Customer Service

Telephone 781-280-0300
Sales Fax 781-280-0495
Service Fax 781-280-0499
email csupport@harmanspecialtygroup.com

Product Shipments

16 Progress Road
Billerica, MA 01821-5730 USA

harman specialty group

Lexicon Part No. 070-15993 | Rev 1 | 04/05

Manufactured under license from Dolby Laboratories. Dolby, Pro Logic, Surround EX, and the double-D symbol are trademarks of Dolby Laboratories.

Manufactured under license from THX Ltd. U.S. patent numbers 5,043,970; 5,189,703; and/or 5,222,059. European patent number 0323830. Other U.S. and foreign patents pending. Ultra2 and THX are trademarks or registered trademarks of THX Ltd. Surround EX is a trademark of Dolby Laboratories. Used under authorization.

DTS, DTS-ES, Neo:6, and DTS 96/24 are trademarks of Digital Theater Systems, Inc.

Lexicon, Logic 7 and the L7 logo are registered trademarks of Harman International Industries, Inc. U.S. Patent Nos. D454,553; D454,860; 5,796,844; 5,870,480 and other worldwide patents issued and pending.

© 2005 Harman International Industries, Inc. All rights reserved.

This document should not be construed as a commitment on the part of Harman Specialty Group. The information it contains is subject to change without notice. Harman Specialty Group assumes no responsibility for errors that may appear within this document.

DOCUMENTATION CONVENTIONS

This document contains general operation instructions for the MC-12 and MC-12 Balanced Digital Controllers. It is important to read this user guide before attempting to use this product.

The following symbols are used in this document:

CAUTION

Calls attention to a procedure, practice, condition or the like that, if not correctly performed or adhered to, could result in damage to or destruction of part or all of the product.

Note:

Calls attention to information that is essential to highlight.

SETUP ➤ **INPUTS** ➤ **DVD1** ➤ **DVD1 INPUT SETUP**

Represents a menu path. The menu items in gray boxes must be selected with the right arrow button to access the menu or menu item in the black box. For instance, the SETUP, INPUTS, and DVD1 menu items must be selected to open the DVD1 INPUT SETUP menu.

The DVD1 input is used here as an example, and will continue to be used as an example throughout this document. Whenever it appears as a step in a menu path, any other input may be substituted. Likewise, whenever the DVD1 INPUT SETUP menu appears, any other INPUT SETUP menu may be substituted.

This document uses the term MC-12 to refer to both the MC-12 and MC-12 Balanced Digital Controllers unless otherwise specified.

Section 1: Understanding Room Equalization

Loudspeaker Sound in a Room	1-2
Room Modes	1-5
<i>Surround Sound Issues</i>	1-6

Section 2: Configuring the MC-12 for EQ

About Automatic Calibration	2-3
Connecting the Microphones	2-5
Positioning the Microphones for the Microphone Check	2-6
Performing the Microphone Check	2-8
Repositioning the Microphones for Automatic Calibration	2-10
Performing Automatic Calibration	2-16
Adjusting Room Correction	2-21
<i>Room EQ</i>	2-21
<i>Room EQ Level</i>	2-21
<i>Remote Control Commands</i>	2-22
EQ Menu Trees	2-23
<i>Check Microphones</i>	2-23
<i>EQ Distances or Levels</i>	2-24
<i>Room EQ</i>	2-25
<i>Audio Controls</i>	2-25
<i>Distances or Output Levels</i>	2-26

Understanding Room Equalization

Loudspeaker Sound in a Room. 1-2
Room Modes 1-5
Surround Sound Issues 1-6

UNDERSTANDING ROOM EQUALIZATION

Sections one and two of this document explain the conditions that create the need for room equalization, how the MC-12 can compensate for room variances, and how to properly set up the microphones to run equalization tests. The theoretical material in this section was authored by Dr. James Muller, Lexicon senior software engineer.

LOUDSPEAKER SOUND IN A ROOM

The way that sound from a speaker behaves outdoors (in open air) or in an anechoic chamber is different from the way it behaves in a room. The sound from a speaker in open air or in an anechoic chamber radiates outward in straight lines. (Actually, the theory of wave propagation is quite complex, but the "straight line" concept is valid for uniform air properties and is therefore accurate enough to be useful.) In a typical listening room, a small amount of the sound reaches the listener directly, as shown in Figure 1-1.

Figure 1-1. The listener directly hears a fraction of the total sound.

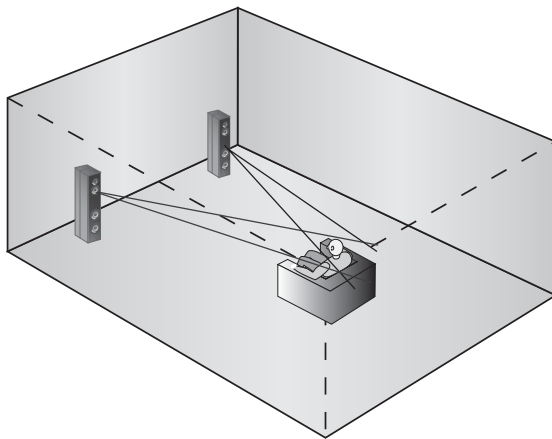

Most of the sound in a room is reflected off walls, the floor and the ceiling, as shown in Figure 1-2.

Figure 1-2. The listener hears mostly reflected sound.

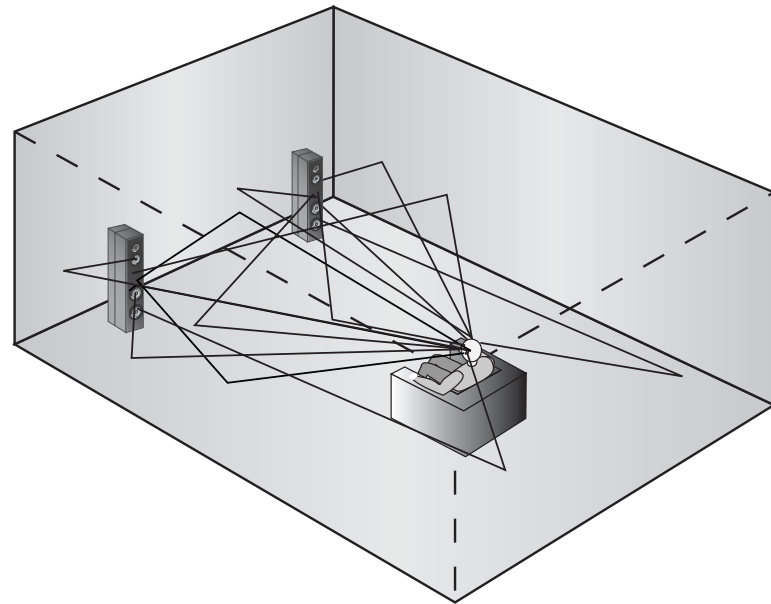

In addition, a typical listening room also contains furniture, windows, door openings and people. Every object and surface contributes a reflection.

The strength of each reflection depends on how the wavelength of the sound compares to the size of the reflecting object, and on the transmission properties of the reflector. A good general principle to remember is that if the wavelength is longer than the size of the object, the wave will pass around the object as if it wasn't there. If the wavelength is shorter, strong reflections will occur. For example, the wavelength of 100Hz is 11 feet, so it will pass around any person standing in a room. The wavelength of 1000Hz is only 1.1

feet, so it will be scattered by any person (or object bigger than 1 foot) in the room. The strength of reflections also depends on the transmission properties of the reflector. For example, depending on its size and stiffness, a wall may have its own resonant frequency. This can happen when a sound wave of sufficient amplitude hits the wall and causes it to resonate.

Parallel walls can reflect sound back and forth many times, as shown in Figure 1-3. When multiple copies of the same waveform are “added together,” they do not necessarily produce louder sound. Multiple reflections could cause an increase of more than 10dB. Yet, the level could be *reduced* by 10dB or more. The relative timing between the two sounds (phase difference) determines what actually happens. The end result of all these reflections is that you hear an extremely complicated sum that cannot be easily characterized. Fortunately our ears (actually, our brains) are able to sort through the resultant sound and interpret it all as the “room sound.” As we get accustomed to the room sound reflections, they become a critical part of our enjoyment of most music. Without the room reflections, most people would find the perceived audio quite uninteresting, even unpleasant. Logic 7 recreates these reflections.

Figure 1-3. Parallel walls reflect sound multiple times.

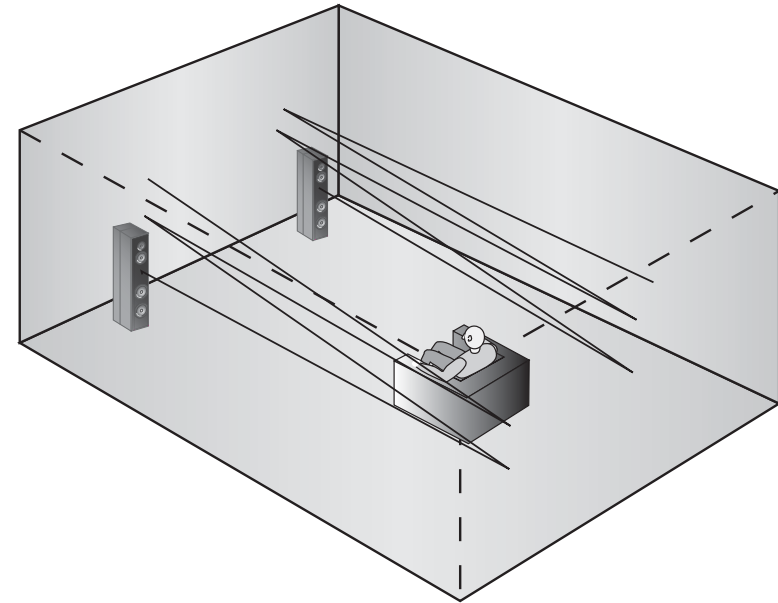

If you can imagine sound waves as moving objects, it is easier to think about how they interact with common objects such as humans and furniture. The wavelength of audible sound can be as long as 57 ft (20Hz) or as short as 2/3 of an inch (20kHz). A 1kHz sound wave will be about a foot long when it leaves the speaker, and it will bounce off of almost everything solid (people, walls, furniture) in its path. A 100Hz sound wave will be 11 feet long after leaving the speaker and, because of its length, won't bounce off of nearly as many surfaces as the 1kHz sound wave. This concept is shown in Figure 1-4.

Figure 1-4. Bass frequencies, which have longer wavelengths, behave more predictably than higher frequencies.

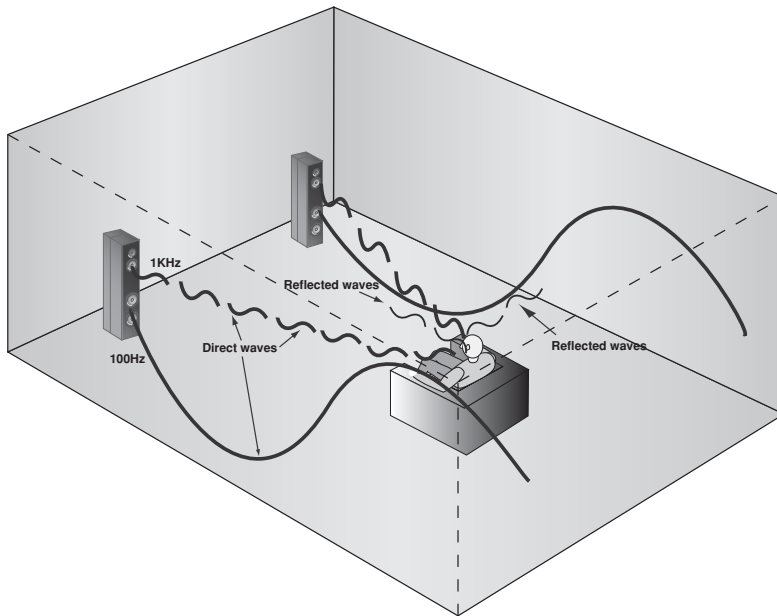

The low frequencies tend to behave in predictable ways because the bass wavelengths are larger than the typical objects in a room. The mid and high frequencies generally behave differently from room to room because the foot-by-foot or inch-by-inch details differ dramatically from room to room. No two rooms have the same exact placement of chairs, tables, lamp shades, bookshelves or people.

Good speaker designers know that there are differences from one room to another and try to develop speaker systems that take advantage of the room. However, they do not know the specifics

of your particular room; how big it is, the arrangement of the furniture, speaker placement and so on.

Designers can correct for some speaker characteristics. For example, a typical cone driver does not radiate all frequencies evenly in all directions. With a floorstanding speaker, designers know how far above the floor each driver in the speaker will be. With this knowledge, they can specify details such as how far from a wall or corner their speaker should be placed. However, they must still design to some typical room. Your room might be quite different from what is thought to be typical.

Getting good sound in your room requires that you try to avoid setting it up in a manner that will create problems the speaker designer could not anticipate. Following are some tips for arranging your listening room for optimal enjoyment (see Figure 1-5):

- If the room is still under construction, you should try to avoid building large enclaves or rectangular cavities such as foyers, bay windows, stairway entrances, and so on. Such spaces resonate specific frequencies and affect the sound quality within the room.
- Try not to place speakers in cabinets or build them into walls unless the manufacturer has specified them for such applications.
- Speakers designed to be freestanding should be used that way; likewise, those designed to be set against a wall or in a corner should be used that way. Every close boundary wall provides a boost in the bass, so a speaker placed inappropriately with respect to the wall will produce either insufficient or excessive bass.
- Seats should be positioned away from walls and corners. Seating positions too close to one or more walls will be subject to bass increases.

Figure 1-5. Tips for arranging your listening room.

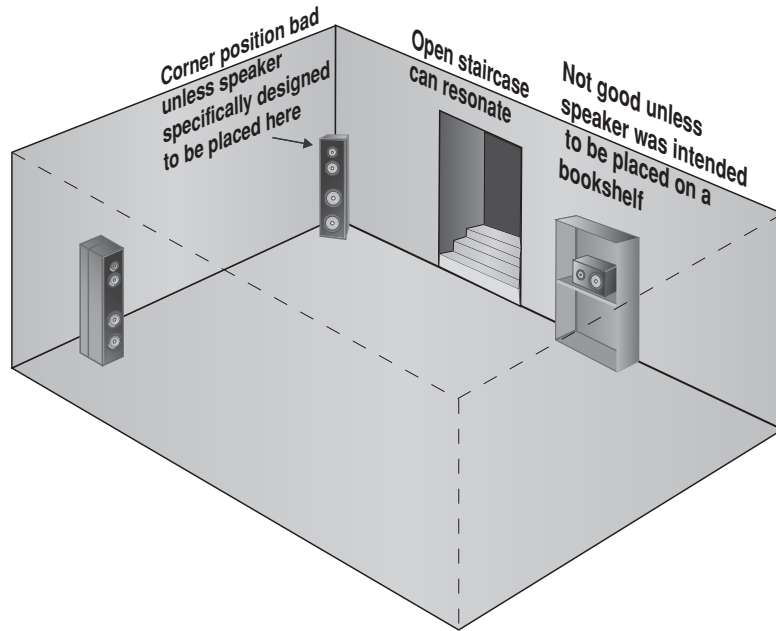

ROOM MODES

Room modes are resonances that occur when low frequencies reinforce each other as they reflect back and forth between the hard boundaries of the room. The size of the room determines at which particular frequencies it resonates. Room modes can cause the subwoofer to sound very loud for one note, and fairly quiet for another. A typical room will exhibit many room modes. For rooms with parallel walls, the significant low-frequency modes can be predicted to occur at any frequency for which an even number of quarter wavelengths will fill the space between two opposite walls. For example, a room that is 18 feet long will exhibit a resonance

along its length at wavelengths of 36 ft (31Hz), 18 ft (63Hz), 12 ft (94Hz), and so on. Each dimension of length, width and ceiling height will resonate independently at its own frequencies.

Figure 1-6. Resonance modes along the length of a room.

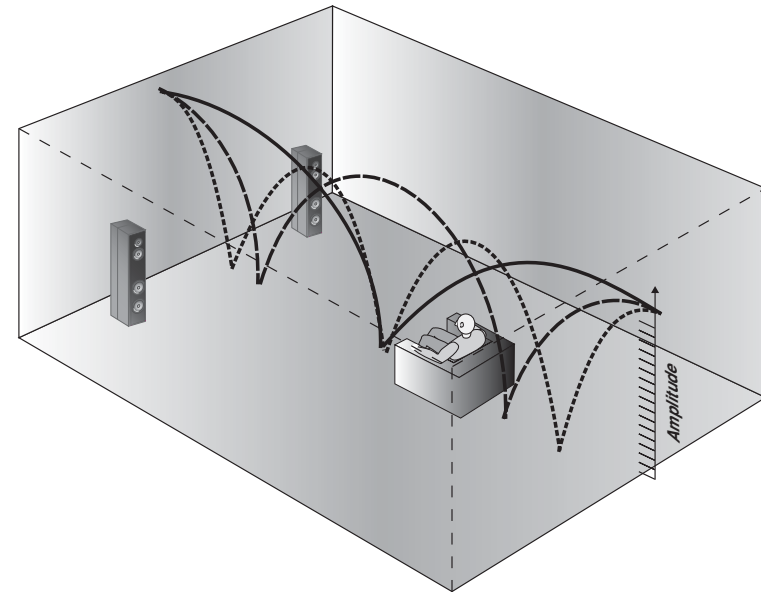

The resulting sound in the room is the addition (possibly in a complex mathematical way) of all the room's modes. Other factors, such as wall stiffness or the position of furniture in the room, can also affect the modes. At higher frequencies, these effects become less predictable and can change as people move around the room. However, the low-frequency modes are predictably consistent. Any problems produced by the low-frequency modes will always be present, but those problems can be mitigated.

Room modes affect the frequency response you hear in several ways. The most pronounced effect of room modes is to make certain frequencies too loud. You can correct this to some degree with an equalizer. Strong resonances have an additional feature: those frequencies linger on. When a speaker creates sound at the frequency of a strong resonance mode, that sound lingers in the room after the speaker has stopped vibrating. For a very strong resonance, the sound could linger as long as half a second. In the worst cases, that sound will also have a distinct pitch.

Listeners do not always notice this “extra” sound because the frequencies of stable modes are usually too low to be discernible as a detail unless the listener specifically listens for them. Rather, the usual problem is that the lingering sound can obscure other parts of the music. For example, the lingering sound from a kick drum could mask the details of a following vocal passage. Subjectively, you might feel as if you were listening to the music through a layer of gauze. You might try to fix things by turning up the overall volume, turning down the overall volume, or by tweaking your audio controls (bass, treble, tilt EQ, or loudness). However, none of these fixes can provide satisfactory results. For example, turning down the bass sufficiently to solve the problem with the kick drum will probably leave all the low frequencies seemingly too low in amplitude. By comparison, were you to listen to the same recording through headphones (headphones eliminate room modes, since they are tightly coupled to the ear), you wouldn’t have the problem. You might then describe the sound of the same recording played back in your room as having “flabby bass,” and assume the cause is your system or your speakers. In fact, if you are really hearing room modes the flabby bass is not caused by your speakers; it is caused by your room.

The too-slow decay of a resonance mode can be corrected only by applying the proper filter. The severity of a resonance mode is defined by its “Q” value (which historically meant Quality Factor). The higher the Q of a resonance, the bigger its amplitude and the slower its decay.

The presence of a resonance with high Q is not a desirable condition in listening rooms. Proper treatment of a resonance requires a filter with not only the correct frequency and depth, but also the correct Q. Graphic equalizers offer neither a variety of Q values nor a fine enough frequency selection. A good parametric equalizer can be made to work, but you would first need to have the expertise and equipment to measure the room's resonances. This could be a difficult and time-consuming task.

The EQ procedure identifies room resonances and measures both their Q and frequency in a highly precise manner. Using this information, it then applies the proper parametric filters to neutralize these resonances. You can run the EQ procedure by following the simple set of instructions in section 2 of this user guide.

Surround Sound Issues

Surround sound is a key component of modern multimedia presentations. An action-movie DVD may have great video, but the moving image of an explosion offers little thrill to the viewer without an accompanying BOOM! A tire-screaming vehicle entering the field of view from the left is more effective if the accompanying audio comes from the left also. The surround sound system is what makes it all work. Properly setting up a surround sound system is essential. In most installations, the seating positions pose a bigger problem than the system setup.

The two key adjustments for each speaker are timing and level. The subtle differences in timing of the sound coming out of each of several speakers is what gives you (the listener) a sense of direction. These subtle timing differences can be as short as a few milliseconds. If you are too close to one speaker in the system, many of the audio effects will seem to come from only that direction because the sound from that speaker arrives at your ears too early. Since sound travels a bit faster than 1100 feet per second, each foot of travel takes just under a millisecond. So if one speaker is 5 feet too

close to you, its sound will arrive at your ears approximately 5 milliseconds too early.

The surround processor distance settings allow the surround sound system to delay the sound from each speaker just enough to realign them all to each other. Levels must also be balanced because a speaker positioned too close to you will be too loud compared to the other speakers.

Perfect settings for level and distance apply to only one position in the room. For example, if one seat is 8 feet from every speaker in the room, no other location in the room will also be exactly 8 ft from them all. A seat to the left of that first one might be 3 feet closer to the left side speaker, and the same amount further away from the right side speaker. No single set of distances will fit both seat positions. Fortunately, our perception will tolerate some deviation from “perfect” level and distance settings. In Figure 1-7, the distance value for the side speakers is set to a location about midway between the two seats, giving an error of only 1.5 feet for both side speakers for both seats.

Figure 1-7. Distance setting point for side speakers.

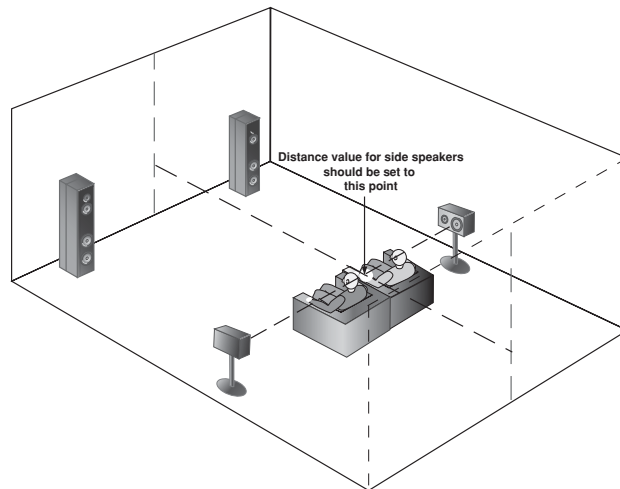

When a room has multiple viewing positions, the distance and level settings will be more accurate if all of those seats are clustered together as closely as possible (Figure 1-8).

Figure 1-8. Seats should be clustered together as much as possible.

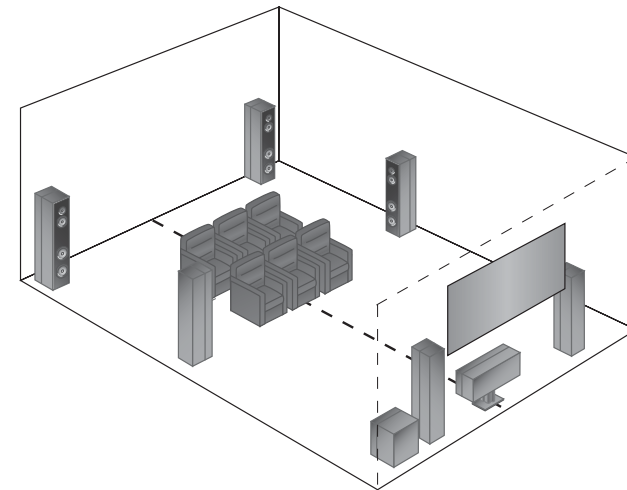

If a favorite listening chair must be located in a remote corner of the room (Figure 1-9), the listeners will have to choose whether to accommodate the remote seat or to ignore it. No set of values will

work perfectly for everyone if one or more seats are too far away from the "average" position. Any compromise to accommodate remote seats will degrade the audio for everyone.

Figure 1-9. If system is optimized for the remote corner seat, the audio will be degraded for all.

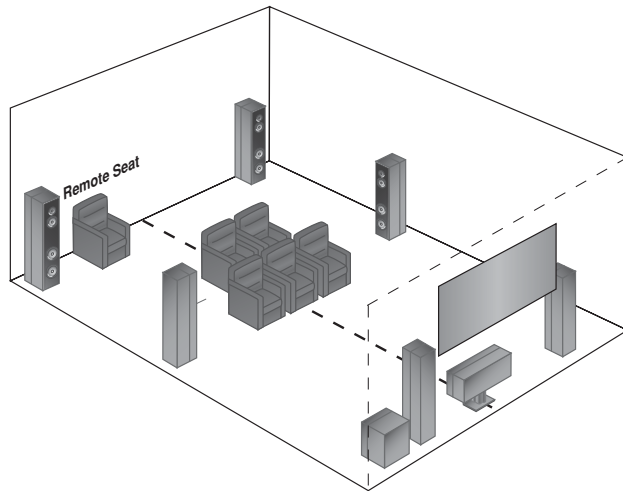

Configuring the MC-12 for EQ

About Automatic Calibration	2-3
Connecting the Microphones	2-5
Positioning the Microphones for the Microphone Check	2-6
Performing the Microphone Check	2-8
Repositioning the Microphones for Automatic Calibration	2-10
Performing Automatic Calibration	2-16
Adjusting Room Correction	2-21
<i>Room EQ</i>	2-21
<i>Room EQ Level</i>	2-21
<i>Remote Control Commands</i>	2-22
EQ Menu Trees	2-23
<i>Check Microphones</i>	2-23
<i>EQ Distances or Levels</i>	2-24
<i>Room EQ</i>	2-25
<i>Audio Controls</i>	2-25
<i>Distances or Output Levels</i>	2-26

ABOUT AUTOMATIC CALIBRATION

When running the EQ software, the MC-12 offers automatic calibration of the listening room's bass response, loudspeaker distances, and loudspeaker output levels. *A successful microphone check is required before automatic calibration procedures can be performed.*

The *Automatic Calibration Procedures* table on the next page describes all automatic calibration procedures.

BEFORE performing automatic calibration:

- ✓ Use the **CUSTOM** or **THX SETUP** menu to set crossover points for the loudspeakers connected to the **Main Zone audio output connectors**. Setting crossover points, after automatic calibration is performed, can invalidate calibrated output levels.
- ✓ Set all associated component (e.g., subwoofers, loudspeakers, and power amplifiers) volume controls to a reasonable level. During automatic calibration, the MC-12 outputs calibration noise signals at fixed volume levels. However, when automatic calibration ends, the MC-12 automatically reverts to the last volume level that was selected before automatic calibration was performed.
- ✓ Eliminate extraneous noises in the listening room, including conversations, air conditioners, and sounds that filter in through open doors and windows.
- ✓ Remove objects, including people, blocking the line-of-sight path between the microphones and the loudspeakers.

DURING automatic calibration:

- ✓ Calibrate the listening room's bass response **BEFORE** calibrating loudspeaker output levels. Room correction applied to the loudspeakers as a result of the **EQ DISTANCES LEVELS** or **ROOM EQ** procedure can affect loudspeaker output levels, particularly those of the subwoofer and low frequency effect (LFE) subwoofer.
- ✓ The MC-12 outputs calibration noise signals between 55 and 95dB, starting at 55dB and increasing in 5dB increments until the microphones detect the required level. If calibration noise signals become too loud, press the **◀ arrow** button to cancel automatic calibration.
- ✓ Refer to the **on-screen display** rather than the **front panel display**. The **on-screen display** provides additional information and instructions.

Procedure	Description
CHECK MICROPHONES	<p>Examines the microphones connected to the rear panel microphone input connectors.</p> <ul style="list-style-type: none"> ✓ Confirms that the microphones are properly connected and functioning. ✓ Calculates an average microphone level, allowing the MC-12 to compensate for individual microphone sensitivities. ✓ Ensures that microphone levels are consistent, eliminating errors that result from individual microphone level differences.
EQ DISTANCES LEVELS	<p>Calibrates the listening room's bass response, loudspeaker distances, and loudspeaker output levels.</p> <ul style="list-style-type: none"> ✓ Requires minimal interaction. ✓ Measures the listening room's bass resonance characteristics. ✓ Applies appropriate room correction to the loudspeakers to minimize bass resonances. ✓ Sets the AUDIO CONTROLS menu ROOM EQ parameter to ON and ROOM EQ LEVEL parameter to MEDIUM. These parameters can now be used to activate and deactivate room correction and to control the amount of room correction applied to the loudspeakers. Refer to <i>Adjusting Room Correction</i> (page 2-21). ✓ Calibrates loudspeaker distances within ± 0.5 foot (0.15m) of the physical distance between the listening position(s) and the loudspeaker. ✓ Calibrates individual loudspeaker output levels within ± 0.5dB of each other. ✓ Calibrates overall loudspeaker output levels within ± 3.0dB of THX reference levels (75.0dB). ✓ Automatically applies calibrated loudspeaker distances and output levels.
ROOM EQ	<p>Calibrates the listening room's bass response.</p> <ul style="list-style-type: none"> ✓ Measures the listening room's bass resonance characteristics. ✓ Applies appropriate room correction to the loudspeakers to minimize bass resonances. ✓ Sets the AUDIO CONTROLS menu ROOM EQ parameter to ON and ROOM EQ LEVEL parameter to MEDIUM. These parameters can now be used to activate and deactivate room correction and to control the amount of room correction applied to the loudspeakers. Refer to <i>Adjusting Room Correction</i> (page 2-21).
DISTANCES	<p>Calibrates loudspeaker distances.</p> <ul style="list-style-type: none"> ✓ Calibrates loudspeaker distances within ± 0.5 foot (0.15m) of the physical distance between the listening position(s) and the loudspeaker. ✓ Provides a comparison between original and calibrated loudspeaker distances, allowing for selection of the desired distances.
OUTPUT LEVELS	<p>Calibrates loudspeaker output levels.</p> <ul style="list-style-type: none"> ✓ Calibrates individual loudspeaker output levels within ± 0.5dB of each other. ✓ Calibrates overall loudspeaker output levels within ± 3.0dB of THX reference levels (75.0dB). ✓ Provides a comparison between original and calibrated loudspeaker output levels, allowing for selection of the desired output levels.

CONNECTING THE MICROPHONES

Automatic calibration requires the microphones included in the *Lexicon Microphone Kit*, which is available at authorized Lexicon dealers. *Performing automatic calibration with other microphones will produce unknown results.*

CAUTION

- The microphones included in the *Lexicon Microphone Kit* require careful handling. Dropping or otherwise physically abusing the microphones may cause errors during use or irreparable damage to the microphones. Read and observe the documentation included with the *Lexicon Microphone Kit* to ensure optimal microphone performance.
- The microphone wires also require careful handling. Do not sharply bend the wires or place objects on them.
- Never make or break microphone input connections unless the MC-12 is powered off using the rear panel power switch or placed in standby mode using the front panel or remote control standby button.

To connect the microphones:

1. Make sure the MC-12 is powered off using the rear panel **power switch** or placed in standby mode using the front panel or remote control **standby button**.

Figure 2-1. Microphone input connectors on MC-12 rear panel.

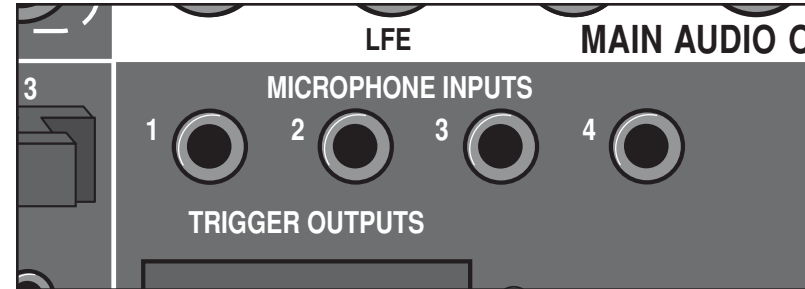

2. Connect the microphones included in the *Lexicon Microphone Kit* to the **microphone input connectors** on the MC-12 rear panel (shown in Figure 2-1). Make sure microphone cable plugs are fully inserted for solid connections.

Note:

*During the microphone check, the MC-12 refers to the microphones as 1, 2, 3, and 4 based on the **microphone input connector** to which the microphone is connected. Label the microphones for troubleshooting purposes.*

3. Power on the MC-12 or take the MC-12 out of **standby mode**.

POSITIONING THE MICROPHONES FOR THE MICROPHONE CHECK

Proper microphone placement is essential to achieve the desired automatic calibration results. Refer to the microphone placement examples that begin below to properly position the microphones for the microphone check.

PROPER

Figure 2-2. Proper microphone placement for the microphone check.

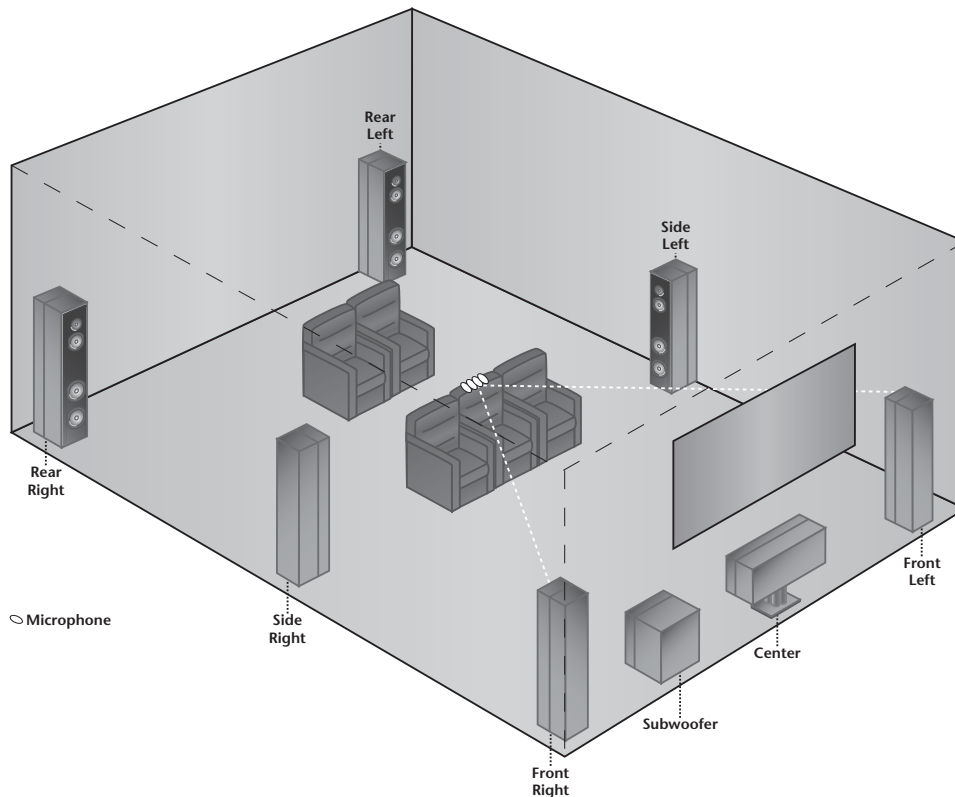

The microphones **SHOULD** be positioned:

- ✓ As close together as possible
- ✓ Relatively centered between and equidistant from the front left and right loudspeakers
- ✓ In a clear line-of-sight path with the loudspeakers
- ✓ In a location unobstructed by furniture and other fixtures
- ✓ In a location where echoes will not obscure calibration noise signals
- ✓ At least 2 feet (0.61m) from all loudspeakers and walls
- ✓ Within 30 feet (9.14m) of all loudspeakers.

The listening room to the left shows **proper** microphone placement for the **microphone check**. The microphones are clustered in an unobstructed location that is relatively centered between and equidistant from the front left and right loudspeakers.

IMPROPER

Figure 2-3. Improper microphone placement for the microphone check.

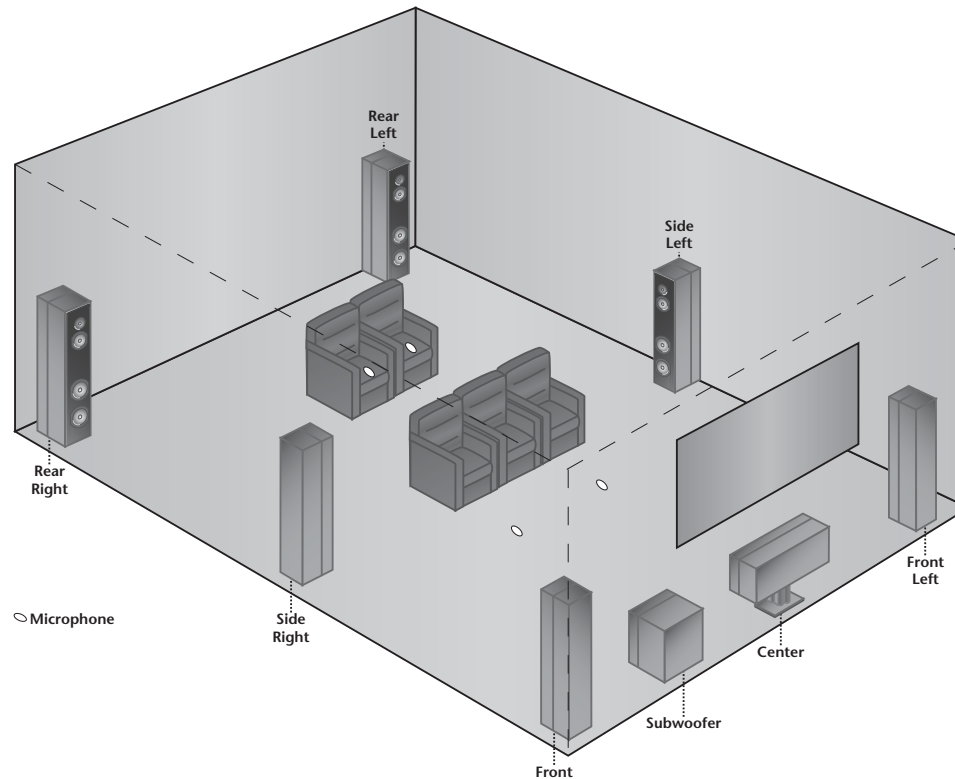

The microphones SHOULD NOT be positioned:

- ✗ In separate locations
- ✗ In locations scattered throughout the listening room
- ✗ In an obstructed line-of-sight path with the loudspeakers
- ✗ In a location obstructed by furniture and other fixtures
- ✗ Within 2 feet (0.61m) of loudspeakers and walls
- ✗ More than 30 feet (9.14m) from any one loudspeaker.

The listening room to the left shows **improper** microphone placement for the **microphone check**. The microphones are scattered throughout the listening room in locations that are neither centered between nor equidistant from the front left and right loudspeakers. In addition, the microphones are positioned in obstructed locations on the floor and on seat cushions.

PERFORMING THE MICROPHONE CHECK

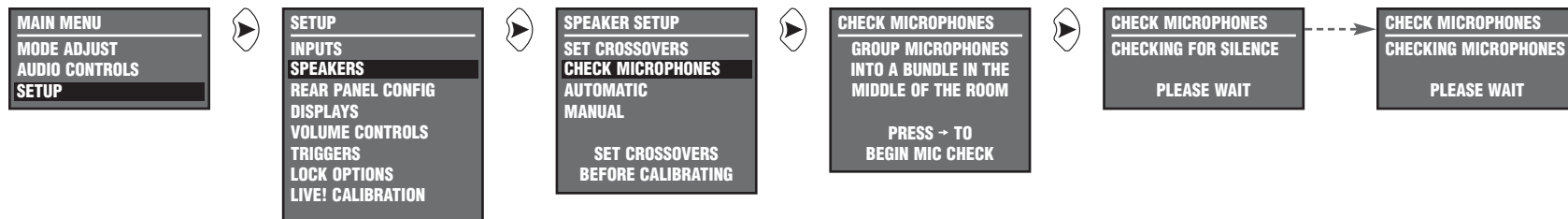

1. Open the **SPEAKER SETUP** menu as shown above.
2. Press the **▲** and **▼** arrow buttons to highlight the **CHECK MICROPHONES** procedure. Then, press the **▶** arrow button to begin this procedure.
3. The **CHECK MICROPHONES** screen (shown above) opens on the on-screen display, emphasizing the importance of proper microphone placement to achieve the desired automatic calibration results.

Refer to *Positioning the Microphones for the Microphone Check* (page 2-6) to ensure that the microphones are properly positioned for the microphone check. Then, press the **▶** arrow button to continue.

The **CHECKING FOR SILENCE** message (shown above) appears on the on-screen display while the MC-12 determines the relative noise level of the listening room and the internal noise level of the microphones. After eliminating microphones that are not detected or not functioning, the MC-12 calculates an average microphone level.

The **CHECKING MICROPHONES** message (shown above) appears on the on-screen display while the MC-12 confirms the microphone level calculated during the silence check. To do this, the MC-12 sends alternating calibration noise signals to the front left and right loudspeakers, eliminating microphones that detect the signal at an unusually low or high level. Then, the MC-12 determines the appropriate output level for the calibration noise signal used during automatic calibration.

Note:

*The MC-12 outputs calibration noise signals between 55 and 95dB, starting at 55dB and increasing in 5dB increments until the microphones detect the required level. If calibration noise signals become too loud, press the **◀** arrow button to cancel automatic calibration.*

The **CHECK MICROPHONES results** screen (shown to the right) opens on the on-screen display when the MC-12 finishes checking the microphones. This screen provides the results for each microphone. (The MC-12 refers to the microphones as 1, 2, 3, and 4 based on the microphone input connector to which the microphone is connected.)

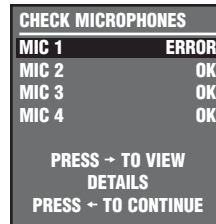

CHECK MICROPHONES	
MIC 1	ERROR
MIC 2	OK
MIC 3	OK
MIC 4	OK

PRESS -> TO VIEW
DETAILS
PRESS + TO CONTINUE

- **OK** indicates that the microphone passed the microphone check.
- **ERROR** indicates that the microphone did not pass the microphone check.

4. Press the **▲** and **▼** arrow buttons to highlight the desired microphone.
5. Press the **▶** arrow button to view more detailed results for the selected microphone. The *CHECK MICROPHONES Results* table on the next page describes all possible results.

Once a successful microphone check has been performed:

- The MC-12 retains the determined microphone level until the **SPEAKER SETUP** menu is closed. *Once this menu is closed, another microphone check is required before automatic calibration can be performed.*

- Do not disconnect the microphones from the **microphone input connectors**. If the microphones are disconnected, perform the microphone check again before performing automatic calibration.

Result	Description	Troubleshooting
(MICROPHONE) OK	The microphone detected calibration noise signals without error.	N/A
(MICROPHONE) NOT DETECTED	The MC-12 did not detect the microphone during the silence check.	<ul style="list-style-type: none"> Examine the microphone input connection to ensure that the microphone is properly connected to the MC-12. Make sure the microphone cable plug is fully inserted for a solid connection. The microphone may be damaged. Contact an authorized Lexicon dealer for assistance.
(MICROPHONE) SIGNAL TOO LOW	The microphone level determined during the silence check was not confirmed during the microphone check.	<ul style="list-style-type: none"> Examine the microphone input connection to ensure that the microphone is properly connected to the MC-12. Make sure the microphone cable plug is fully inserted for a solid connection. The microphone may be positioned too far from the front loudspeakers. Refer to <i>Positioning the Microphones for the Microphone Check</i> (page 2-6) to ensure that the microphones are properly positioned for the microphone check. The microphone may be damaged. Contact an authorized Lexicon dealer for assistance.
(MICROPHONE) OUT OF RANGE	The microphone level is more than 20dB below the highest microphone level.	<ul style="list-style-type: none"> Examine the microphone input connection to ensure that the microphone is properly connected to the MC-12. Make sure the microphone cable plug is fully inserted for a solid connection. The microphone may be positioned too far from the front loudspeakers. Refer to <i>Positioning the Microphones for the Microphone Check</i> (page 2-6) to ensure that the microphones are properly positioned for the microphone check. The microphone may be damaged. Contact an authorized Lexicon dealer for assistance.
(MICROPHONE) TOO MUCH ROOM NOISE	The microphone level could not be determined because of excessive noise in the listening room.	<ul style="list-style-type: none"> Eliminate extraneous noises in the listening room, including conversations, air conditioners, and sounds that filter in through open doors and windows. The microphone may be damaged. Contact an authorized Lexicon dealer for assistance.

REPOSITIONING THE MICROPHONES FOR AUTOMATIC CALIBRATION

Proper microphone placement is essential to achieve the desired automatic calibration results. Microphone placement determines whether the MC-12 calibrates optimal results for a single listening position; several listening positions in a single row; or several listening positions in the listening room.

For best results, automatic calibration should be performed with four microphones that have passed the microphone check. However, the MC-12 performs automatic calibration as long as at least one microphone has passed the microphone check. In this case, place the successfully checked microphone in the primary listening position.

Refer to the microphone placement examples that begin below to properly position the microphones for all automatic calibration procedures.

PROPER

Figure 2-4. Proper microphone placement to achieve the best results for a single listening position.

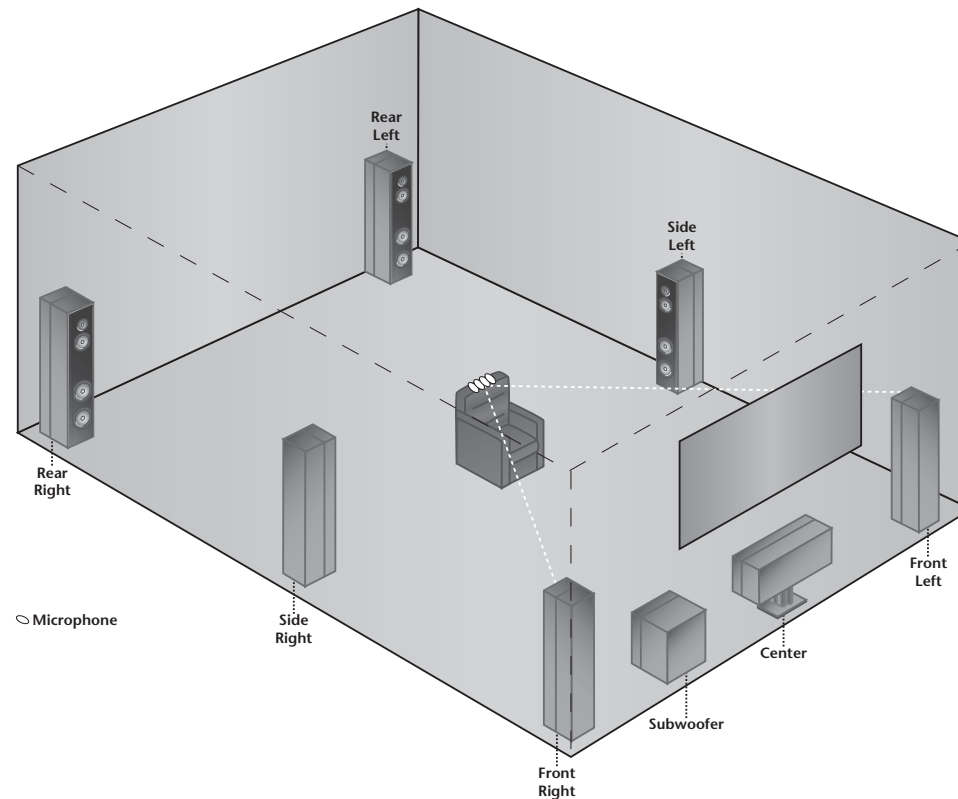

The microphones **SHOULD** be positioned:

- ✓ As close together as possible in a single listening position (the primary listening position)
- ✓ At the approximate spot where the listener's head will be during listening
- ✓ In a clear line-of-sight path with all loudspeakers
- ✓ In a location unobstructed by furniture and other fixtures
- ✓ In a location where echoes will not obscure calibration noise signals
- ✓ At least 2 feet (0.61m) from all loudspeakers and walls
- ✓ Within 30 feet (9.14m) of all loudspeakers.

The listening room to the left shows **proper** microphone placement for **automatic calibration** to achieve the best results for a **single listening position**. The microphones are clustered in the primary listening position at the approximate spot where the listener's head will be during listening. As a result, the MC-12 calibrates optimal results for the selected listening position.

PROPER

Figure 2-5. Proper microphone placement to achieve the best results for several listening positions in a single row.

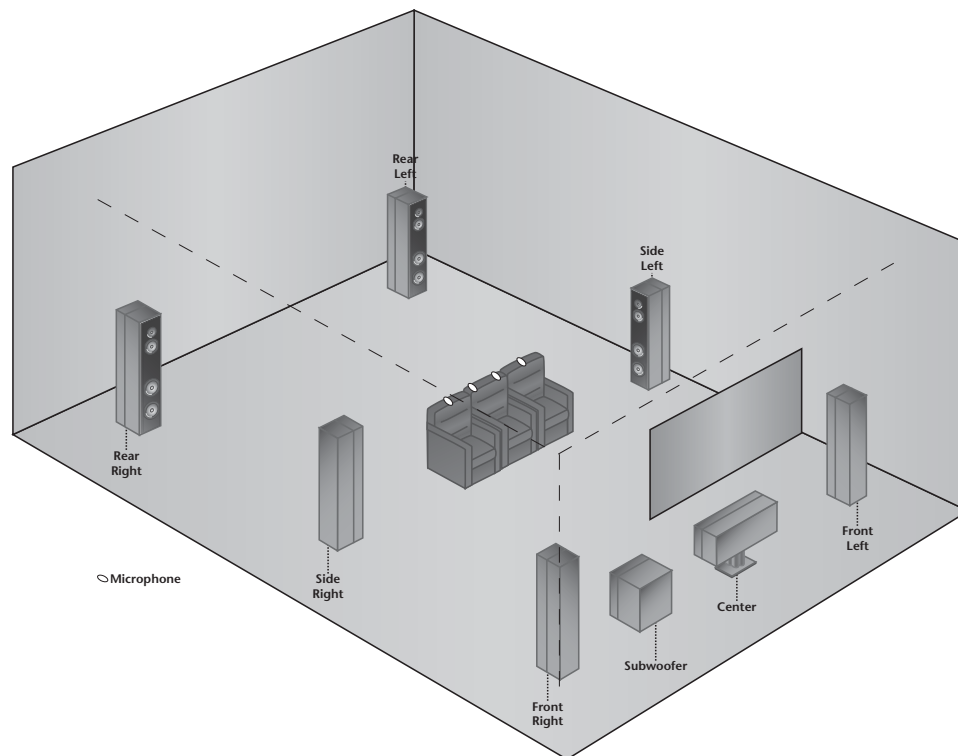

The microphones **SHOULD** be positioned:

- ✓ Across a single row of listening positions
- ✓ At the approximate spots where the listeners' heads will be during listening
- ✓ In a clear line-of-sight path with all loudspeakers
- ✓ In a location unobstructed by furniture and other fixtures
- ✓ In a location where echoes will not obscure calibration noise signals
- ✓ At least 2 feet (0.61m) from all loudspeakers and walls
- ✓ Within 30 feet (9.14m) of all loudspeakers.

The listening room to the left shows **proper** microphone placement for **automatic calibration** to achieve the best results for **several listening positions in a single row**. The microphones are positioned across a single row at the approximate spots where the listeners' heads will be during listening. As a result, the MC-12 calibrates optimal results for the selected row at the expense of a single listening position.

PROPER

Figure 2-6. Proper microphone placement to achieve the best results for several listening positions within the listening room.

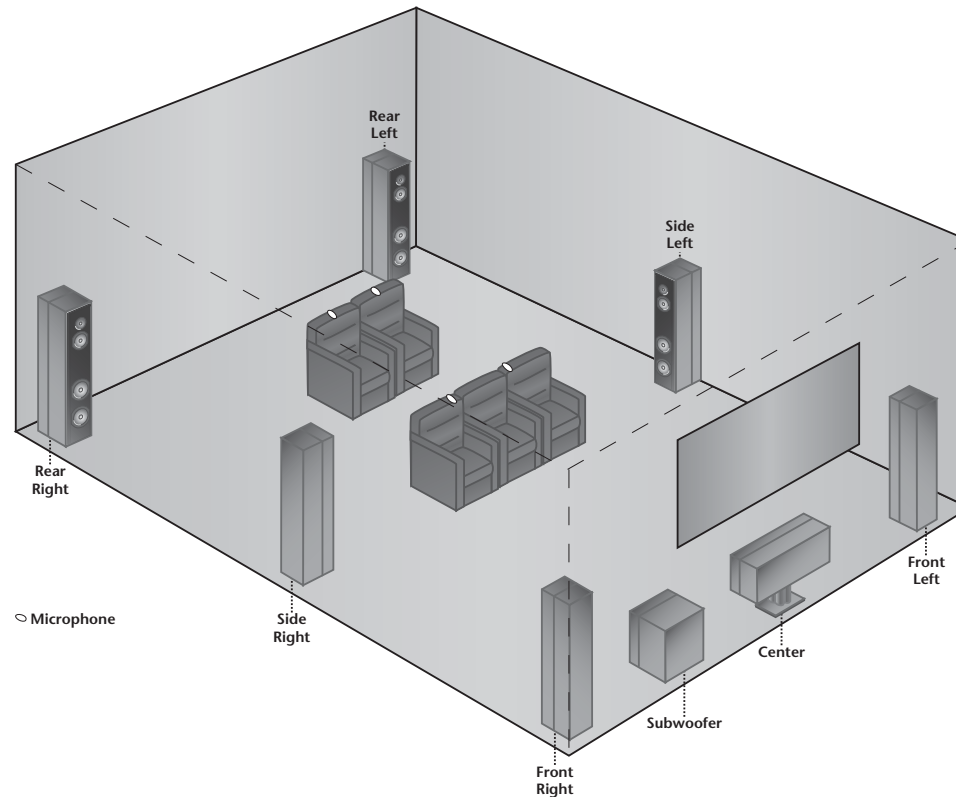

The microphones **SHOULD** be positioned:

- ✓ In single listening positions within the listening room
- ✓ At the approximate spots where the listeners' heads will be during listening
- ✓ In a clear line-of-sight path with all loudspeakers
- ✓ In a location unobstructed by furniture and other fixtures
- ✓ In a location where echoes will not obscure calibration noise signals
- ✓ At least 2 feet (0.61m) from all loudspeakers and walls
- ✓ Within 30 feet (9.14m) of all loudspeakers.

The listening room to the left shows **proper** microphone placement for **automatic calibration** to achieve the best results for **several listening positions in the listening room**. Each microphone is positioned in a single listening position at the approximate spot where the listener's head will be during listening. As a result, the MC-12 calibrates optimal results for the selected listening area at the expense of a single listening position.

IMPROPER

Figure 2-7. Improper microphone placement for automatic calibration.

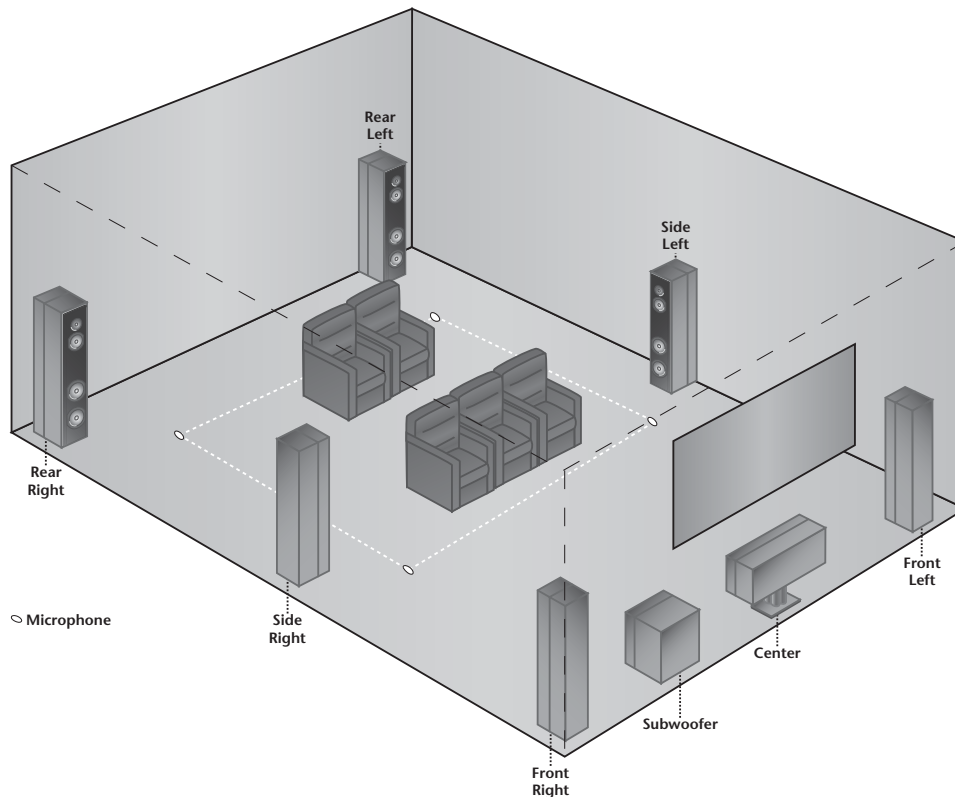

The microphones SHOULD NOT be positioned:

- ✗ Along the perimeter of the listening positions or listening area
- ✗ In spots where listeners' heads will not be during listening
- ✗ In an obstructed line-of-sight path with the loudspeakers
- ✗ In a location obstructed by furniture and other fixtures
- ✗ Within 2 feet (0.61m) of loudspeakers and walls
- ✗ More than 30 feet (9.14m) from any one loudspeaker.

The listening room to the left shows **improper** microphone placement for the **automatic calibration**. The microphones are positioned along the perimeter of the listening area, making it difficult for the MC-12 to calibrate optimal results for actual listening positions. In addition, the microphones are positioned in obstructed locations on the floor.

IMPROPER

Figure 2-8. Improper microphone placement for automatic calibration.

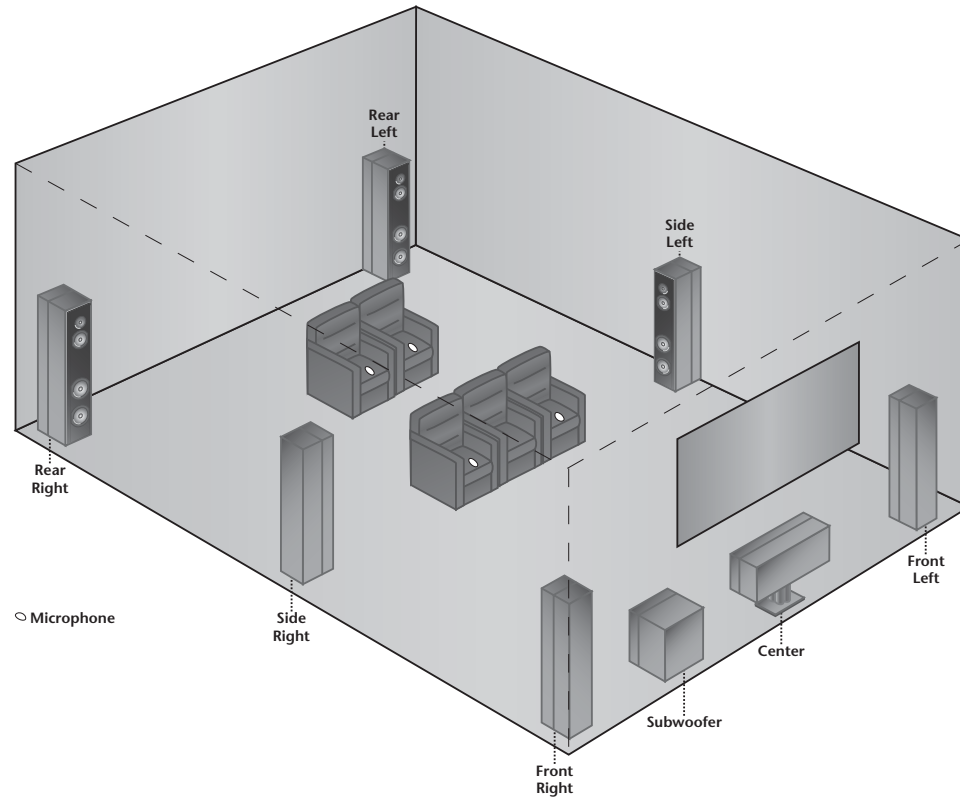

The microphones SHOULD NOT be positioned:

- ✗ Along the perimeter of the listening positions or listening area
- ✗ In spots where listeners' heads will not be during listening
- ✗ In an obstructed line-of-sight path with the loudspeakers
- ✗ In a location obstructed by furniture and other fixtures
- ✗ Within 2 feet (0.61m) of loudspeakers and walls
- ✗ More than 30 feet (9.14m) from any one loudspeaker.

The listening room to the left shows **improper** microphone placement for the **automatic calibration**. The microphones are positioned in obstructed locations on seat cushions rather than in spots where listeners' heads will be during listening.

PERFORMING AUTOMATIC CALIBRATION

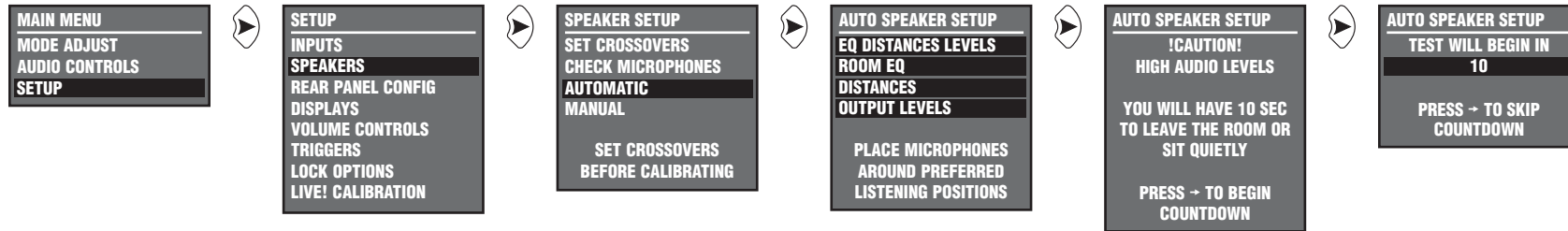

Follow the instructions in the appropriate table column below to perform the desired automatic calibration procedure.

Step	DISTANCES or OUTPUT LEVELS	EQ DISTANCES LEVELS	ROOM EQ
1	<p>Open the AUTO SPEAKER SETUP menu as shown above.</p> <ul style="list-style-type: none"> The AUTO SPEAKER SETUP menu is not available unless a successful microphone check has been performed. If one of the error messages shown to the right appears on the on-screen display, refer to <i>Performing the Microphone Check</i> (page 2-8). 		<div style="border: 1px solid black; padding: 5px; width: fit-content;">MIC CHECK REQUIRED FOR AUTO CALIBRATION</div> <div style="border: 1px solid black; padding: 5px; width: fit-content; margin-top: 5px;">NO MICROPHONES DETECTED</div>
2	Press the ▲ and ▼ arrow buttons to highlight the desired automatic calibration procedure. Then, press the ▶ arrow button to select this procedure.		
3	<p>The !CAUTION! HIGH AUDIO LEVELS screen (shown above) opens on the on-screen display, reminding that the MC-12 outputs loud calibration noise signals during automatic calibration. Press the ▶ arrow button to continue.</p> <p><i>Note: If calibration noise signals become too loud, press the ◀ arrow button to cancel automatic calibration.</i></p>		
4	<p>The TEST WILL BEGIN IN screen (shown above) opens on the on-screen display, activating a 10-second countdown until automatic calibration begins. To skip the countdown and begin automatic calibration, press the ▶ arrow button.</p> <ul style="list-style-type: none"> Otherwise, the MC-12 automatically begins automatic calibration when the countdown ends. During the countdown, it is possible to leave the listening room without affecting automatic calibration. Return to the listening room about 20 minutes later to avoid interrupting the procedure. 		

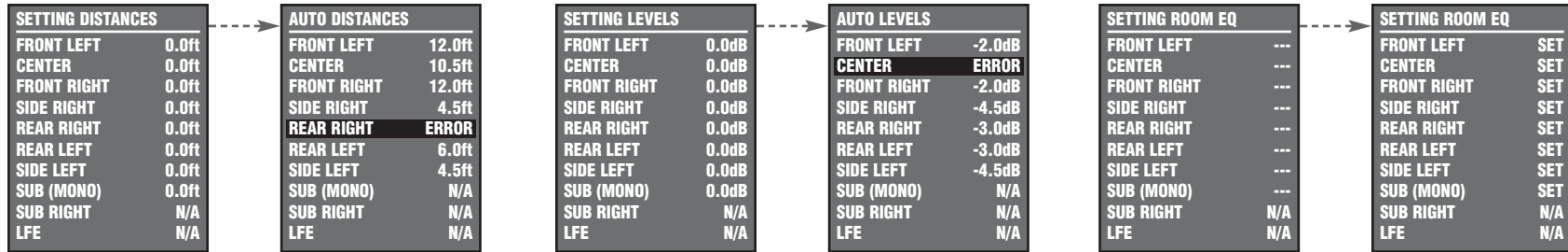

Step	DISTANCES or OUTPUT LEVELS	EQ DISTANCES LEVELS	ROOM EQ
5	This step does not occur during the DISTANCES or OUTPUT LEVELS procedures.	The SETTING ROOM EQ screen (shown above) opens on the on-screen display while the MC-12 measures the listening room's bass response. To do this, the MC-12 sends calibration noise signals to the loudspeakers connected to the Main Zone audio output connectors in the order shown on the screen. The cursor automatically scrolls downward, highlighting each parameter while the MC-12 applies appropriate room corrections to the corresponding loudspeaker. When finished, the MC-12 enters SET to the right of the parameter label.	
6	<p>The SETTING DISTANCES or SETTING LEVELS screen (shown above) opens on the on-screen display while the MC-12 calibrates loudspeaker distances or output levels. To do this, the MC-12 sends calibration noise signals to the loudspeakers connected to the Main Zone audio output connectors in the order shown on the screen. The cursor automatically scrolls downward, highlighting each parameter while the MC-12 calculates a distance or output level for the corresponding loudspeaker. When finished, the MC-12 enters the calculated value or ERROR to the right of the parameter label.</p> <p>Note the following:</p> <ul style="list-style-type: none"> During the EQ DISTANCES LEVELS procedure, the SETTING DISTANCES screen opens on the on-screen display while the MC-12 calibrates loudspeaker distances. Then, the SETTING LEVELS screen opens on the on-screen display while the MC-12 calibrates loudspeaker output levels. In most listening rooms, low-frequency signal propagation makes automatic loudspeaker distance calibration unreliable for subwoofers and LFE subwoofers. Because of this, the MC-12 does not send calibration noise signals to subwoofers. Instead, the MC-12 calibrates these loudspeaker distances to the average distance of the front left and right loudspeakers. If desired, the SPEAKER DISTANCES menu can be used to manually adjust subwoofer distances. 		This step does not occur during the ROOM EQ procedure.

AUTO DISTANCES	
FRONT LEFT	12.0ft
CENTER	10.5ft
FRONT RIGHT	12.0ft
SIDE RIGHT	4.5ft
REAR RIGHT	ERROR
REAR LEFT	6.0ft
SIDE LEFT	4.5ft
SUB (MONO)	N/A
SUB RIGHT	N/A
LFE	N/A

AUTO LEVELS	
FRONT LEFT	-2.0dB
CENTER	ERROR
FRONT RIGHT	-2.0dB
SIDE RIGHT	-4.5dB
REAR RIGHT	-3.0dB
REAR LEFT	-3.0dB
SIDE LEFT	-4.5dB
SUB (MONO)	N/A
SUB RIGHT	N/A
LFE	N/A

AUTO SPEAKER SETUP	
DISTANCES	ERROR
LEVELS	OK
ROOM EQ DONE	
AUTO VALUES APPLIED	
PRESS → TO VIEW DETAILS	

ROOM EQ DONE
PRESS → TO CONTINUE
ROOM EQ APPLIED TO ADJUST GO TO AUDIO CONTROLS

Step	DISTANCES or OUTPUT LEVELS	EQ DISTANCES LEVELS	ROOM EQ
7	<p>The AUTO DISTANCES or AUTO LEVELS screen (shown above) opens only if there is an error during loudspeaker distances or output levels calibration. Otherwise, the MC-12 skips to Step 9.</p> <p>This screen provides the results for each loudspeaker:</p> <ul style="list-style-type: none"> • A value indicates that no errors occurred during calibration. • An ERROR indicates that, although a value was calculated, at least one error occurred during calibration. <p>Press the ▲ and ▼ arrow buttons to highlight the desired loudspeaker. Then, press the ▶ arrow button to view more detailed results for the selected loudspeaker. The <i>DISTANCES and OUTPUT LEVELS Results</i> table on the next page describes all possible results.</p>	<p>The AUTO SPEAKER SETUP results screen (shown above) opens on the on-screen display when the MC-12 finishes calibrating loudspeaker output levels.</p> <p>This screen indicates that the ROOM EQ procedure is finished. The AUDIO CONTROLS menu ROOM EQ procedure is automatically set to ON, and the AUDIO CONTROLS menu ROOM EQ LEVEL parameter is automatically set to MEDIUM. These parameters can now be used to activate and deactivate room correction and to control the amount of room correction applied to the loudspeakers. Refer to <i>Adjusting Room Correction</i> (page 2-21).</p> <p>This screen also provides the results for the DISTANCES and LEVELS procedures:</p> <ul style="list-style-type: none"> • OK indicates that no errors occurred during calibration. • ERROR indicates that, although a value was calculated, at least one error occurred during calibration. <p>Press the ▲ and ▼ arrow buttons to highlight the desired procedure. Then, press the ▶ arrow button to open the AUTO DISTANCES or AUTO LEVELS screen. Follow the instructions in the column to the left to view more detailed results for individual loudspeakers.</p>	<p>The ROOM EQ DONE screen (shown above) opens on the on-screen display when the MC-12 finishes applying room correction to the loudspeakers.</p> <p>This screen indicates that the ROOM EQ procedure is finished. The AUDIO CONTROLS menu ROOM EQ parameter is automatically set to ON, and the AUDIO CONTROLS menu ROOM EQ LEVEL parameter is automatically set to MEDIUM. These parameters can now be used to activate and deactivate room correction and to control the amount of room correction applied to the loudspeakers. Refer to <i>Adjusting Room Correction</i> (page 2-21).</p>

DISTANCES and OUTPUT LEVELS Results

Result	Description	Troubleshooting
(SPEAKER) OK	The MC-12 calibrated the distance or output level of the selected loudspeaker without error.	N/A
(SPEAKER) IS NOT ENABLED	The selected loudspeaker is not present in the loudspeaker setup according to the CUSTOM or THX SETUP menu.	<ul style="list-style-type: none"> Use the CUSTOM or THX SETUP menu to add the selected loudspeaker to the loudspeaker setup. (The MC-12 does not calibrate for loudspeakers that are not present in the loudspeaker setup.)
(SPEAKER) OUT OF PHASE	The calibrated distance is accurate, but the microphones detected out-of-phase calibration noise signals.	<ul style="list-style-type: none"> Examine connections between the loudspeaker and the associated amplifier to ensure that loudspeaker wires are not crossed. If the wiring is correct, the error message can be ignored. (Some loudspeaker models will report a phase error even if no phase error exists.) Dipolar loudspeakers may produce this error. However, the MC-12 does not report the error unless at least half of the microphones detect out-of-phase calibration noise signals.
(SPEAKER) SIGNAL TOO LOW	The microphones detected calibration noise signals at unusually low levels.	<ul style="list-style-type: none"> The microphones may be positioned too far from the selected loudspeaker or in a location where echoes obscure calibration noise signals. Refer to <i>Repositioning the Microphones for Automatic Calibration</i> (page 2-10) to ensure that the microphones are properly positioned for automatic calibration. Examine microphone input connections to ensure that the microphones are properly connected to the MC-12. Make sure microphone cable plugs are fully inserted for solid connections.
(SPEAKER) UNABLE TO CALCULATE	The microphones did not detect calibration noise signals, so the MC-12 could not calibrate the distance of the selected loudspeaker.	<ul style="list-style-type: none"> Refer to <i>Repositioning the Microphones for Automatic Calibration</i> (page 2-10) to ensure that the microphones are properly positioned for automatic calibration. Examine microphone input connections to ensure that the microphones are properly connected to the MC-12. Make sure microphone cable plugs are fully inserted for solid connections.
(SPEAKER) MAY NOT BE ACCURATE	At least one of the microphones did not detect calibration noise signals at reasonable levels. As a result, the distance calibrated for the selected loudspeaker may not be accurate.	<ul style="list-style-type: none"> Refer to <i>Repositioning the Microphones for Automatic Calibration</i> (page 2-10) to ensure that the microphones are properly positioned for automatic calibration.
(SPEAKER) SPKR OUTPUT TOO HIGH	The microphones detected calibration noise signals at unusually high levels.	<ul style="list-style-type: none"> Decrease associated amplifier volume levels, including built-in subwoofer amplifiers. The microphones may be positioned too close to the selected loudspeaker. Refer to <i>Repositioning the Microphones for Automatic Calibration</i> (page 2-10) to ensure that the microphones are properly positioned for automatic calibration.
(SPEAKER) SPKR OUTPUT TOO LOW	The microphones detected calibration noise signals at unusually low levels.	<ul style="list-style-type: none"> Increase associated amplifier volume levels, including built-in subwoofer amplifiers. The microphones may be positioned too far from the selected loudspeaker or in a location where echoes obscure calibration noise signals. Refer to <i>Repositioning the Microphones for Automatic Calibration</i> (page 2-10) to ensure that the microphones are properly positioned for automatic calibration.

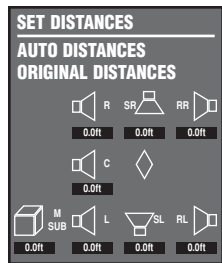

AUTO DISTANCES	
FRONT LEFT	ERROR
CENTER	0.0ft
FRONT RIGHT	0.0ft
SIDE RIGHT	0.0ft
REAR RIGHT	0.0ft
REAR LEFT	0.0ft
SIDE LEFT	0.0ft
SUB (MONO)	0.0ft
SUB RIGHT	N/A
LFE	N/A

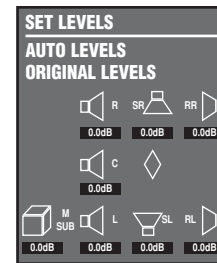

AUTO LEVELS	
FRONT LEFT	ERROR
CENTER	0.0dB
FRONT RIGHT	0.0dB
SIDE RIGHT	0.0dB
REAR RIGHT	0.0dB
REAR LEFT	0.0dB
SIDE LEFT	0.0dB
SUB (MONO)	0.0dB
SUB RIGHT	N/A
LFE	N/A

Step	DISTANCES or OUTPUT LEVELS	EQ DISTANCES LEVELS	ROOM EQ
8	When finished viewing the error found in Step 7, press the ◀ arrow button to open the SET DISTANCES or SET LEVELS screen (shown above).	When finished viewing results, press the ◀ arrow button to return to the AUTO SPEAKER SETUP results screen (shown at the top of page 2-18).	This step does not occur during the ROOM EQ procedure.
9	Press the ▲ and ▼ arrow buttons to toggle between calibrated and original loudspeaker distances or output levels. The graphics, at the bottom of the on-screen display, update to reflect the selected values.	If desired, repeat step 7 (<i>EQ DISTANCES LEVELS</i> column page 2-18) to view more detailed results for the other procedure.	This step does not occur during the ROOM EQ procedure.
10	When the desired loudspeaker distances or output levels are selected, press the ▶ arrow button to apply these values. A confirmation message appears on the on-screen display indicating that the selected values have been applied to the loudspeakers. The SPEAKER DISTANCES menu (MAIN MENU ▶ SETUP ▶ SPEAKERS ▶ MANUAL) can be used to manually adjust loudspeaker distances. The SPEAKER LEVEL ADJUST menu can be used to manually adjust loudspeaker output levels. Refer to the <i>MC-12 User Guide</i> for additional information.	When finished viewing results, press the ◀ arrow button to return to the SPEAKER SETUP menu. The SPEAKER DISTANCES menu (MAIN MENU ▶ SETUP ▶ SPEAKERS ▶ MANUAL) can be used to manually adjust loudspeaker distances. The SPEAKER LEVEL ADJUST menu can be used to manually adjust loudspeaker output levels. Refer to the <i>MC-12 User Guide</i> for additional information.	This step does not occur during the ROOM EQ procedure.

Note:

Once automatic calibration has been performed, use the **BASS PEAK LIMITERS** menu to set amplitude limits for low-frequency signals sent to the **Main Zone audio output connectors** labeled **Subwoofer L/R** and **LFE** and redirected to other output connectors.

ADJUSTING ROOM CORRECTION

Performing the **EQ DISTANCES LEVELS** or **ROOM EQ** procedure enables the **AUDIO CONTROLS** menu **ROOM EQ** and **ROOM EQ LEVEL** parameters, which can be used to activate and deactivate room correction and to control the amount of room correction applied to the loudspeakers.

Note:

Performing the **EQ DISTANCES LEVELS** or **ROOM EQ** procedure automatically sets the **ROOM EQ** parameter to **ON** and the **ROOM EQ LEVEL** parameter to **MEDIUM** (the recommended setting).

ROOM EQ

ON, OFF

Activates and deactivates the room correction that was applied to the loudspeakers during the **EQ DISTANCES LEVELS** or **ROOM EQ** procedure. When set to **ON**, the MC-12 applies room correction to the loudspeakers based on the **ROOM EQ LEVEL** parameter setting. When set to **OFF**, the MC-12 does not apply room correction to the loudspeakers. This parameter has no affect until the **EQ DISTANCES LEVELS** or **ROOM EQ** procedure is performed.

ROOM EQ LEVEL







MAX, HIGH, MEDIUM, LOW

Controls the amount of room correction applied to the loudspeakers when the **ROOM EQ** parameter is set to **ON**. This parameter has no effect when the **ROOM EQ** parameter is set to **OFF**.

The **ROOM EQ LEVEL** parameter can be adjusted in four increments, with **MAX** applying the greatest amount of room correction to the loudspeakers and **LOW** applying the least amount of room correction to the loudspeakers. Setting this parameter is a matter of personal taste, as the effect of each setting varies among input sources and listening rooms.

REMOTE CONTROL COMMANDS

The table below lists remote control commands that can be used to adjust the **ROOM EQ** and **ROOM EQ LEVEL** parameters when the **Zone 2 Command Bank** is activated. These commands are additions to the remote control command matrix in the *MC-12 User Guide*.

Button	Zone 2 Command
	Sets the ROOM EQ LEVEL parameter to LOW .
	Sets the ROOM EQ LEVEL parameter to MEDIUM .
	Sets the ROOM EQ LEVEL parameter to HIGH .
	Sets the ROOM EQ LEVEL parameter to MAX .
	Sets the ROOM EQ parameter to ON .
	Sets the ROOM EQ parameter to OFF .

EQ MENU TREES

When the MC-12 is running EQ, the menu trees shown in this section replace the **AUTO SPEAKER SETUP** and **AUDIO CONTROLS** menu trees shown in the *MC-12 User Guide*.

CHECK MICROPHONES

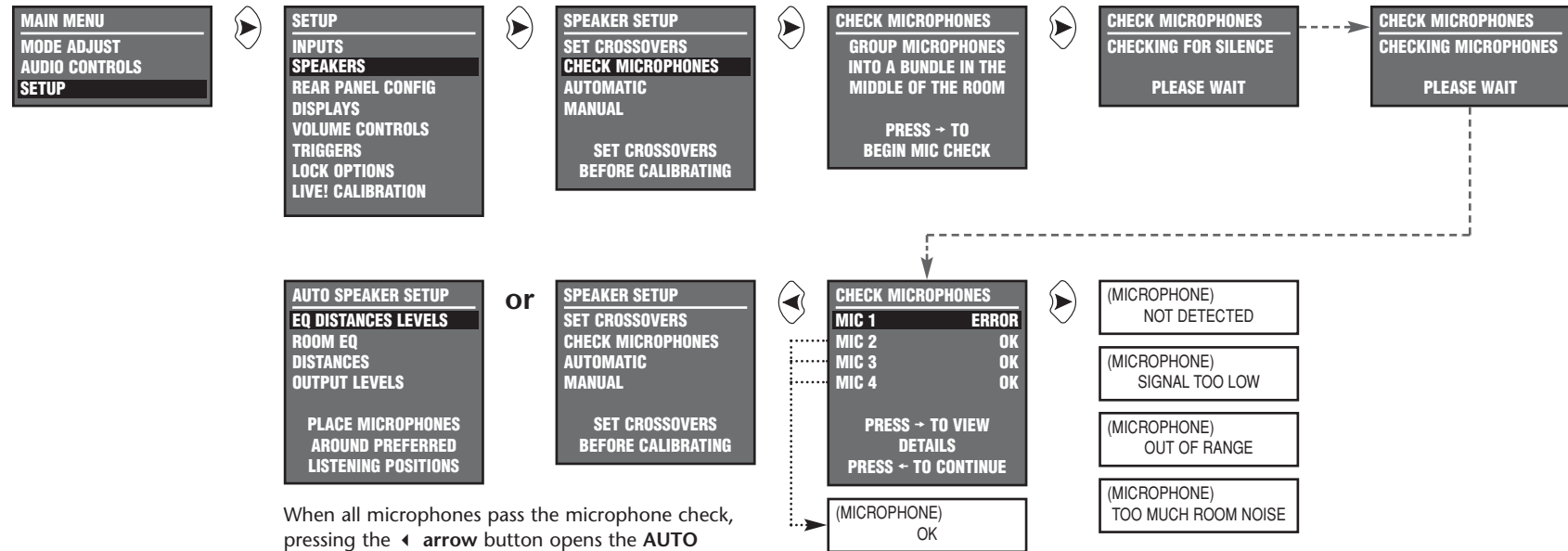

When all microphones pass the microphone check, pressing the **◀ arrow** button opens the **AUTO SPEAKER SETUP** menu. When at least one of the microphones does not pass the microphone check, pressing the **◀ arrow** button opens the **SPEAKER SETUP** menu.

When the **CHECK MICROPHONES** results screen opens, press the **▲ and ▼ arrow** buttons to select the desired microphone parameter. Then, press the **▶ arrow** button to view more detailed microphone check results for the selected microphone.

EQ DISTANCES LEVELS

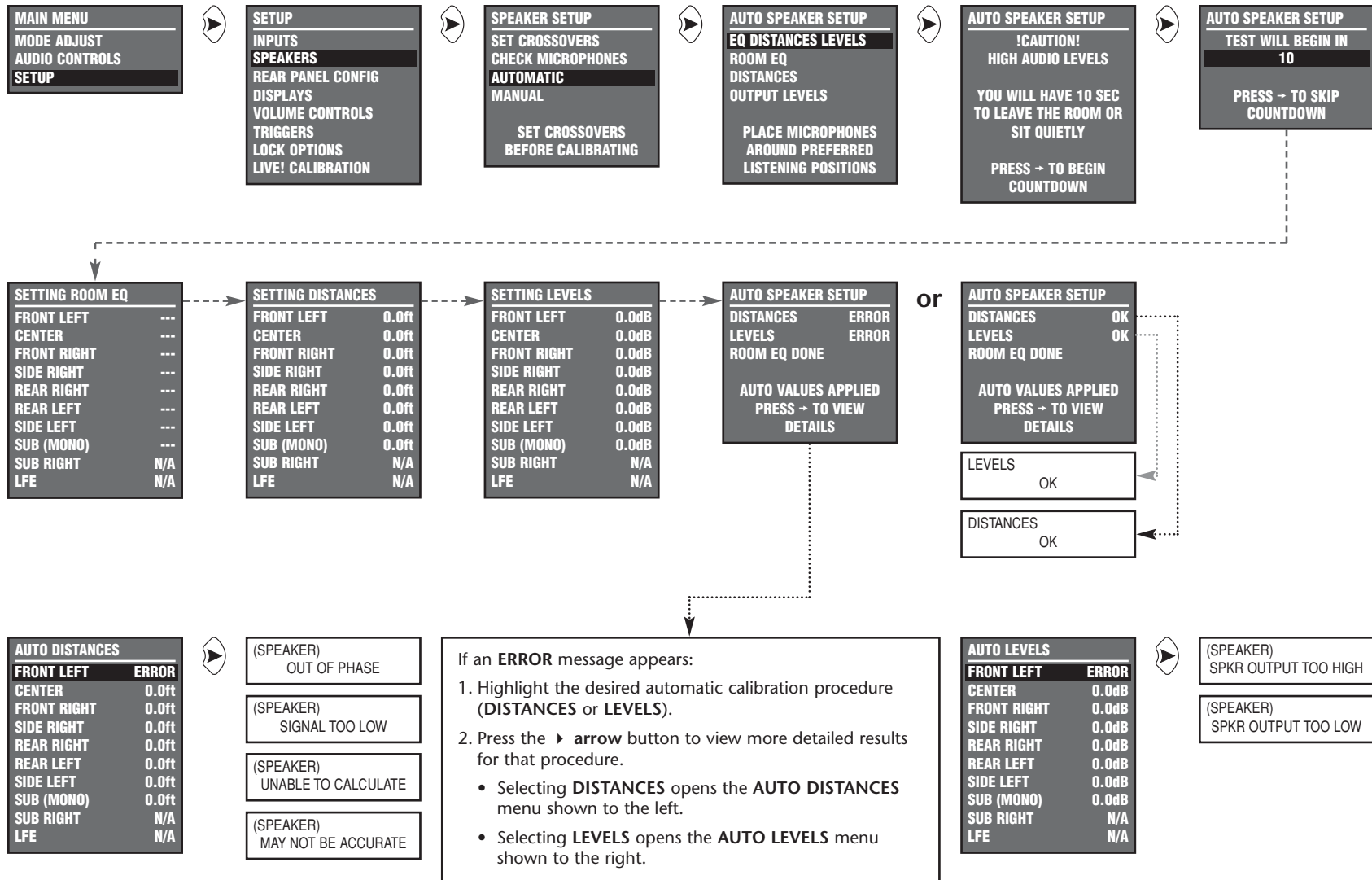

ROOM EQ

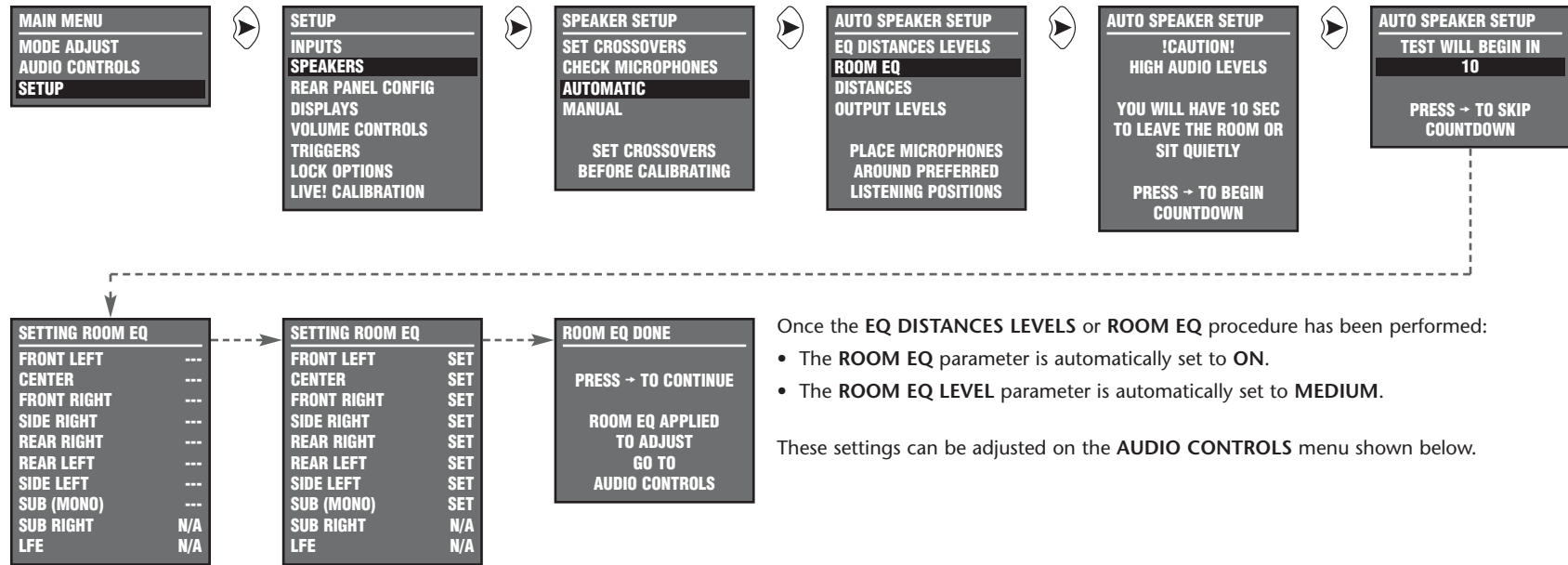

AUDIO CONTROLS

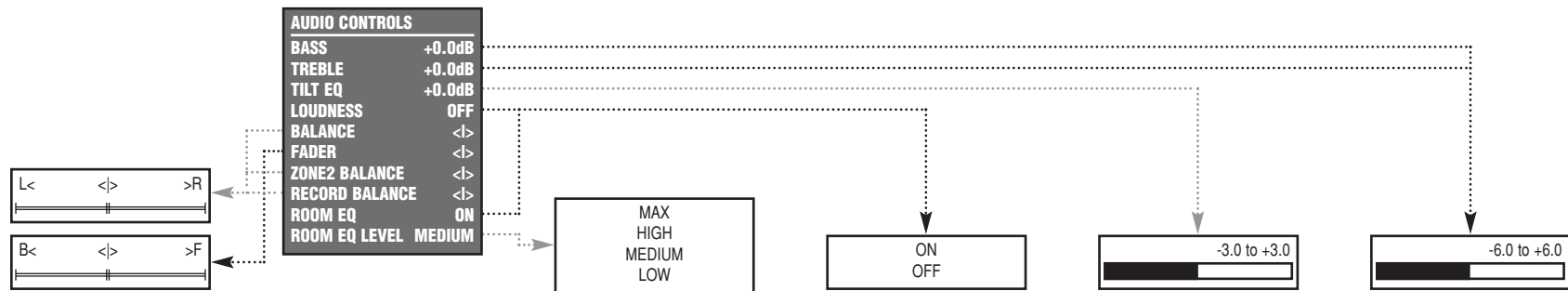

DISTANCES or OUTPUT LEVELS

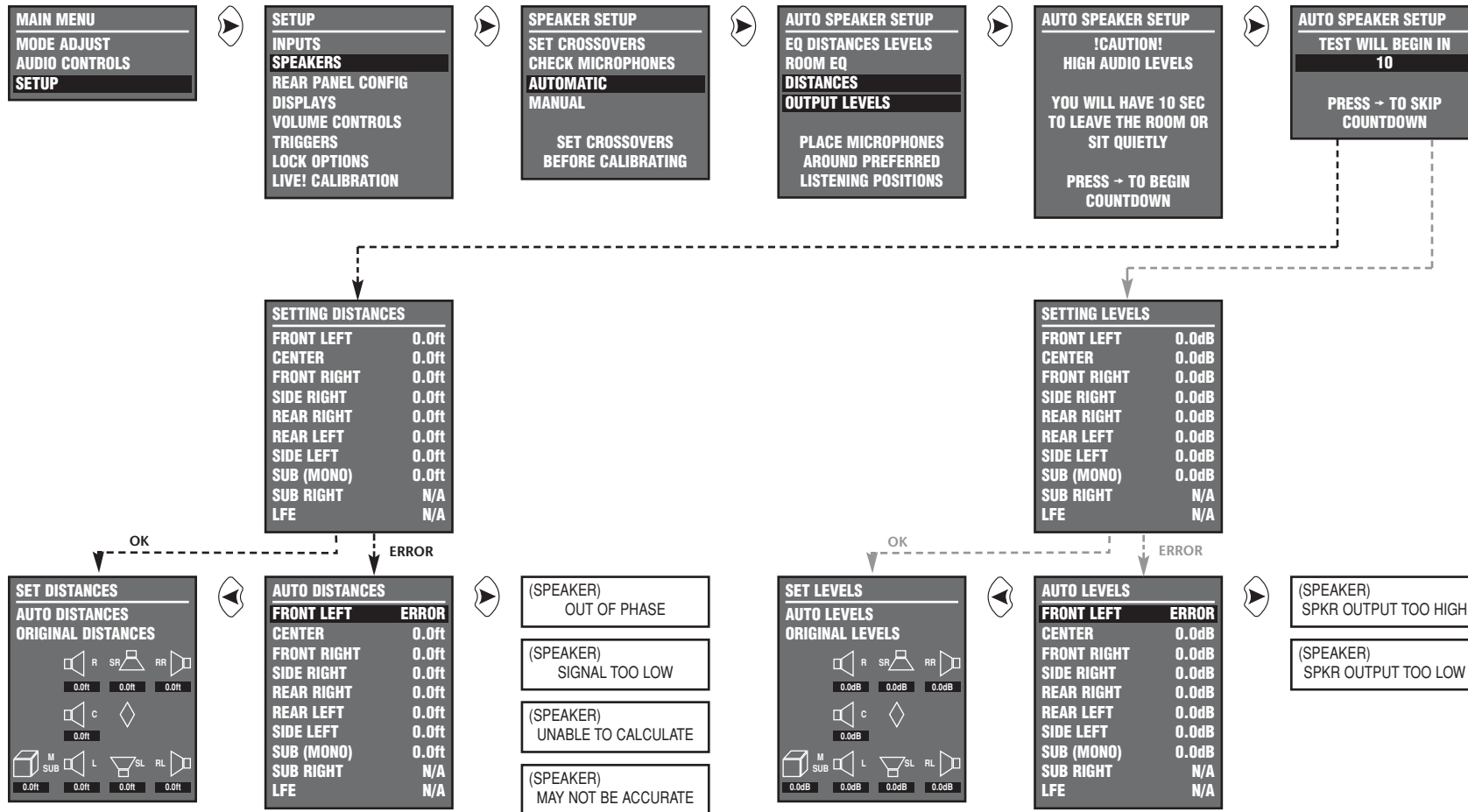



3 Oak Park, Bedford, MA, 01730-1413 USA | Telephone: 781-280-0300 | Fax: 781-280-0490 | www.lexicon.com

Customer Service: Telephone: 781-280-0300 | Sales Fax: 781-280-0495 | Service Fax: 781-280-0499

Product Shipments: 16 Progress Road, Billerica, MA 01821-5730 USA

harman specialty group

Part No. 070-15993 | Rev 1 | 04/05

LIMITED WARRANTY

Lexicon, Inc. offers the following warranty on this product:

What is the Duration of this Warranty?

This warranty will remain in effect for three (3) years from the original date of purchase.

Who is Covered?

This warranty may be enforced by the original purchaser and subsequent owners during the warranty period, provided the original dated sales receipt or other proof of warranty coverage is presented at time of service.

What is Covered?

This warranty covers all defects in material and workmanship on this product, except as specified below. The following are not covered:

1. Damage resulting from
 - A. Accident, misuse, abuse, or neglect.
 - B. Failure to follow instructions contained in the user guide.
 - C. Repair or attempted repair unauthorized by Lexicon, Inc.
 - D. Failure to perform recommended periodic maintenance.
 - E. Causes other than product defects, including lack of skill, competence, or experience on the part of the owner.

2. Damage occurring during any shipment of this product. Claims for shipping damages must be made with the carrier.
3. Damage to a unit that has been altered, or on which the serial number has been defaced, modified, or removed.

What Expenses will Lexicon, Inc. Assume?

Lexicon, Inc. will pay all labor and material expenses for covered items. Payment of shipping charges is discussed in the next section of the warranty.

How is Service Obtained?

When this product needs service, write, telephone, or fax Lexicon, Inc. to request information about where the unit should be taken or sent. When making a written request, please include your name, complete address, and daytime telephone number; the product model and serial numbers; and a description of the problem. Do not return the unit to Lexicon, Inc. without prior authorization.

When Shipping a Product for Service . . .

1. Pay any initial shipping charges, which are the responsibility of the owner. If necessary repairs are covered by this warranty, Lexicon, Inc. will pay return shipping charges to any destination in the United States using the carrier of our choice.
2. Pack the unit securely. Package insurance is strongly recommended.

3. Include a copy of the original dated sales receipt. (A copy of the original dated sales receipt must be presented whenever warranty service is required.)
4. Do not include accessories such as power cords or user guides unless instructed to do so.

What are the Limitations of Implied Warranties?

Any implied warranties, including warranties of merchantability and fitness for a particular purpose, are limited in duration to the length of this warranty.

What Certain Damages are Excluded?

Lexicon's liability for a defective product is limited to repair or replacement of that product, at our option. Lexicon, Inc. shall not be liable for damages based on inconvenience; loss of use of the product; loss of time; interrupted operation; commercial loss; or any other damages, whether incidental, consequential, or otherwise.

How do State Laws Relate to this Warranty?

Some states do not allow limitations on the duration of implied warranties and/or the exclusion or limitation of incidental or consequential damages. As such, the above limitations may not apply.

This warranty is not enforceable outside of North America. This warranty provides specific legal rights. Additional rights may be provided by some states.



PRODUCT REGISTRATION

Please register this product within 15 days of purchase. To do so, complete and return this card or register online at www.lexicon.com. This card serves no warranty purposes. Retain the sales receipt for proof of coverage.

<input type="radio"/> Mr.	<input type="radio"/> Mrs.	<input type="radio"/> Ms.	<input type="radio"/> Miss
<input type="radio"/> Single	<input type="radio"/> Married	<input type="radio"/> Divorced	<input type="radio"/> Widowed
First Name		Last Name	
Company		Title	
Mailing Address			
City		State	Zip
Telephone Number		Fax Number	
Email Address			
Product Model		Purchase Date	
Version		Serial Number	
Where did you purchase this product?			
Age		Education	
<input type="radio"/> Under 18	<input type="radio"/> 18-24	<input type="radio"/> High School	<input type="radio"/> College
<input type="radio"/> 25-34	<input type="radio"/> 35-49	<input type="radio"/> Graduate School	<input type="radio"/> Certificate:
<input type="radio"/> 50-64	<input type="radio"/> 65+	Household Income	
		<input type="radio"/> Under \$20,000	<input type="radio"/> \$20,000 to \$34,999
		<input type="radio"/> \$35,000 to \$49,000	<input type="radio"/> \$50,000 to \$74,999
		<input type="radio"/> \$75,000 to \$99,000	<input type="radio"/> \$100,000+
How did you learn about this product? Choose one:			
<input type="radio"/> Friend	<input type="radio"/> Colleague	<input type="radio"/> Store salesperson	<input type="radio"/> Store display
<input type="radio"/> Teacher	<input type="radio"/> Received as a gift	<input type="radio"/> Advertisement	<input type="radio"/> Magazine Article
<input type="radio"/> Own other Lexicon products			
Which of the following were most important in the selection of this product?			
<input type="radio"/> Sound	<input type="radio"/> Features	<input type="radio"/> Quality	<input type="radio"/> Brandname
<input type="radio"/> Value for price	<input type="radio"/> Other:	<input type="radio"/> Durability	
What are your three favorite magazines?			
1.	2.	3.	
What are your three favorite websites?			
1.	2.	3.	
What features would you like to see added to this product in the future?			

MC-12 EQ | 04/05



Lexicon, Inc.
3 Oak Park
Bedford, MA 01730-1413
USA

Tel 781-280-0300
Fax 781-280-0490
www.lexicon.com

Customer Service

Telephone 781-280-0300
Sales Fax 781-280-0495
Service Fax 781-280-0499
email csupport@harmanspecialtygroup.com



BUSINESS REPLY MAIL
FIRST-CLASS MAIL PERMIT NO. 67 BEDFORD MA

POSTAGE WILL BE PAID BY ADDRESSEE

PRODUCT REGISTRATION
LEXICON, INC
3 OAK PARK
BEDFORD MA 01730-9863

NO POSTAGE
NECESSARY
IF MAILED
IN THE
UNITED STATES

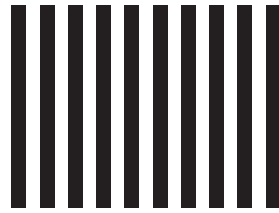

A Harman International Company

Lexicon, Inc.
3 Oak Park
Bedford, MA 01730-1413 USA
Tel 781-280-0300
Fax 781-280-0490
www.lexicon.com

Customer Service
Telephone 781-280-0300
Sales Fax 781-280-0495
Service Fax 781-280-0499
email csupport@harmanspecialtygroup.com

Lexicon Part No. 070-15993 | Rev 1 | 04/05