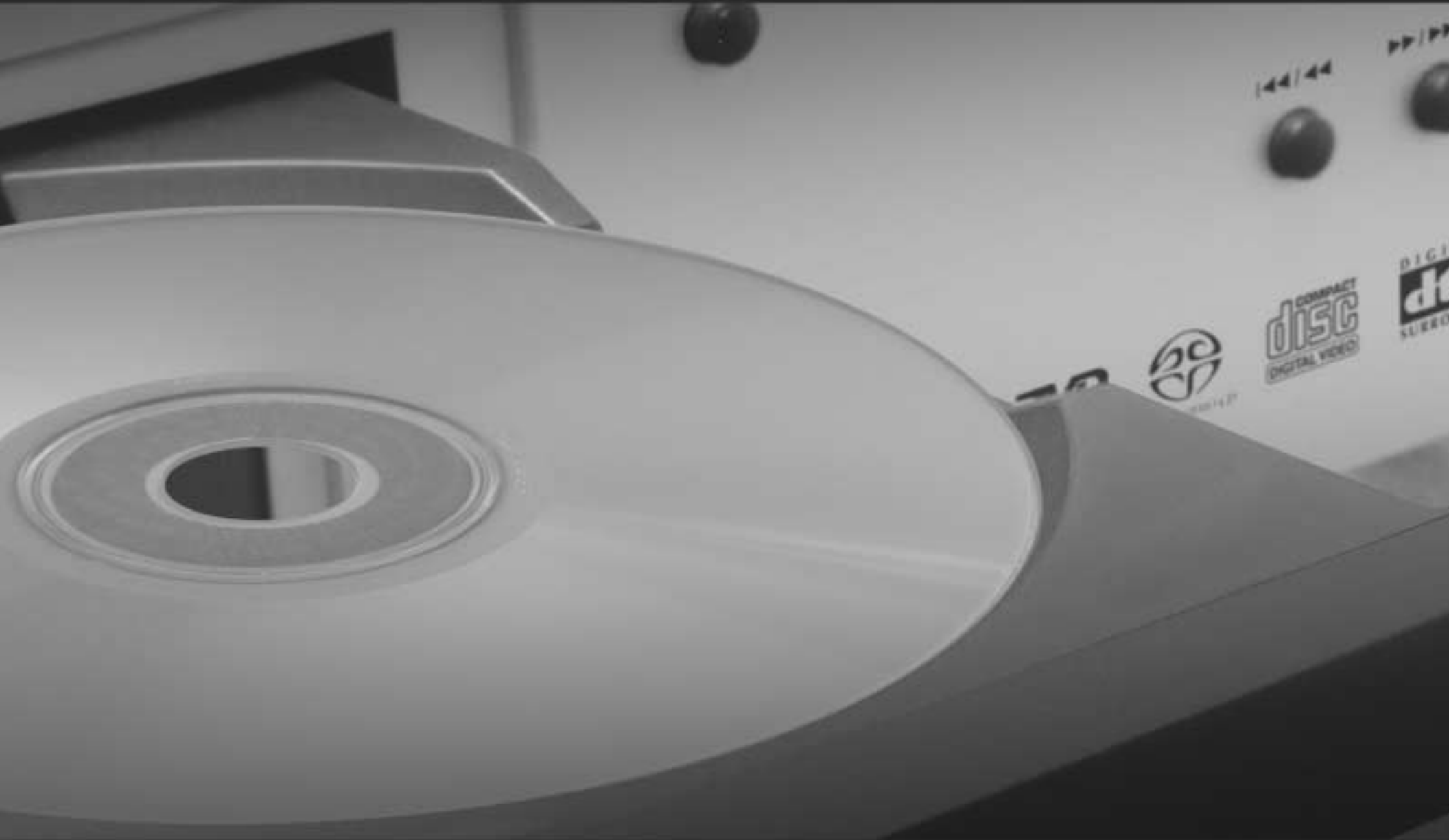


lexicon

***RT-10** Universal Disc Player*

User Guide



IMPORTANT SAFETY INSTRUCTIONS

READ INSTRUCTIONS – All the safety and operating instructions should be read before the product is operated.

RETAIN INSTRUCTIONS – The safety and operating instructions should be retained for future reference.

HEED WARNINGS – All warnings on the product and in the operating instructions should be adhered to.

FOLLOW INSTRUCTIONS – All operating and use instructions should be followed.

CLEANING – Unplug this product from the wall outlet before cleaning. The product should be cleaned only with a polishing cloth or a soft dry cloth. Never clean with furniture wax, benzene, insecticides or other volatile liquids since they may corrode the cabinet.

ATTACHMENTS – Do not use attachments not recommended by the product manufacturer as they may cause hazards.

WATER AND MOISTURE – Do not use this product near water – for example, near a bathtub, wash bowl, kitchen sink, or laundry tub; in a wet basement; or near a swimming pool; and the like.

ACCESSORIES – Do not place this product on an unstable cart, stand, tripod, bracket, or table. The product may fall, causing serious injury to a child or adult, and serious damage to the product. Use only with a cart, stand, tripod, bracket, or table recommended by the manufacturer, or sold with the product. Any mounting of the product should follow the manufacturer's instructions, and should use a mounting accessory recommended by the manufacturer.

CART – A product and cart combination should be moved with care. Quick stops, excessive force, and uneven surfaces may cause the product and cart combination to overturn.



VENTILATION – Slots and openings in the cabinet are provided for ventilation and to ensure reliable operation of the product and to protect it from overheating, and these openings must not be blocked or covered. The openings should never be blocked by placing the product on a bed, sofa, rug, or other similar surface. This product should not be placed in a built-in installation such as a bookcase or rack unless proper ventilation is provided or the manufacturer's instructions have been adhered to.

POWER SOURCES – This product should be operated only from the type of power source indicated on the marking label. If you are not sure of the type of power supply to your home, consult your product dealer or local power company.

LOCATION – The appliance should be installed in a stable location.

NONUSE PERIODS – The power cord of the appliance should be unplugged from the outlet when left unused for a long period of time.

GROUNDING OR POLARIZATION

- If this product is equipped with a polarized alternating current line plug (a plug having one blade wider than the other), it will fit into the outlet only one way. This is a safety feature. If you are unable to insert the plug fully into the outlet, try reversing the plug. If the plug should still fail to fit, contact your electrician to replace your obsolete outlet. Do not defeat the safety purpose of the polarized plug.
- If this product is equipped with a three-wire grounding type plug, a plug having a third (grounding) pin, it will only fit into a grounding-type power outlet. This is a safety feature. If you are unable to insert the plug into the outlet, contact your electrician to replace your obsolete outlet. Do not defeat the safety purpose of the grounding type plug.

POWER CORD PROTECTION – Power-supply cords should be routed so they are not likely to be walked on or pinched by items placed upon or against them, paying particular attention to cords at plugs, convenience receptacles, and the point where they exit from the product.

LIGHTNING – For added protection for this product during a lightning storm, or when it is left unattended and unused for long periods of time, unplug it from the wall outlet and disconnect the antenna or cable system. This will prevent damage to the product due to lightning and power line surges.

POWER LINES – An outside antenna system should not be located in the vicinity of overhead power lines or other electric light or power circuits, or where it can fall into such power lines or circuits. When installing an outside antenna system, extreme care should be taken to keep from touching such power lines or circuits as contact with them might be fatal.

OVERLOADING – Do not overload wall outlets, extension cords, or integral convenience receptacles as this can result in a risk of fire or electric shock.

OBJECT AND LIQUID ENTRY – Never push objects of any kind into this product through openings as they may touch dangerous voltage points or short-out parts that could result in a fire or electric shock. Never spill liquid of any kind on the product.

SERVICING – Do not attempt to service this product yourself as opening or removing covers may expose you to dangerous voltage or other hazards. Refer all servicing to qualified service personnel.

DAMAGE REQUIRING SERVICE – Unplug this product from the wall outlet and refer servicing to qualified service personnel under the following conditions:

- When the power-supply cord or plug is damaged.
- If liquid has been spilled, or objects have fallen into the product.
- If the product has been exposed to rain or water.
- If the product does not operate normally by following the operating instructions. Adjust only those controls that are covered by the operating instructions as an improper adjustment of other controls may result in damage and will often require extensive work by a qualified technician to restore the product to its normal operation.
- If the product has been dropped or damaged in any way.
- When the product exhibits a distinct change in performance – this indicates a need for service.

REPLACEMENT PARTS – When replacement parts are required, be sure the service technician has used replacement parts specified by the manufacturer or have the same characteristics as the original part. Unauthorized substitutions may result in fire, electric shock, or other hazards.

SAFETY CHECK – Upon completion of any service or repairs to this product, ask the service technician to perform safety checks to determine that the product is in proper operating condition.

WALL OR CEILING MOUNTING – The product should not be mounted to a wall or ceiling.

HEAT – The product should be situated away from heat sources such as radiators, heat registers, stoves, or other products (including amplifiers) that produce heat.

This triangle, which appears on your component, alerts you to the presence of uninsulated, dangerous voltage inside the enclosure - voltage that may be sufficient to constitute a risk of shock.



This triangle, which appears on your component, alerts you to important operating and maintenance instructions in this accompanying literature.

**CAUTION: TO REDUCE THE RISK OF ELECTRIC SHOCK, DO NOT REMOVE THE COVER (OR BACK)
NO USER-SERVICEABLE PARTS INSIDE
REFER SERVICING TO QUALIFIED SERVICE PERSONNEL**

WARNING TO REDUCE THE RISK OF FIRE OR ELECTRIC SHOCK, DO NOT EXPOSE THIS UNIT TO RAIN OR MOISTURE.

- Do not remove the cover from the unit.
- Do not insert anything into the unit through the ventilation holes.
- Do not handle the mains lead with wet hands.
- Make a space of about .33ft (0.1m) around the unit.

WARNING Slots and openings on the case are provided for ventilation. To ensure reliable operation of the unit, to protect it from overheating, and to prevent fire hazard, these openings must not be blocked or covered with items such as newspapers, table cloths, or curtains. In addition, do not place the unit on a thick carpet, bed, sofa, or fabric with a thick pile.

WARNING BEFORE PLUGGING IN THE UNIT FOR THE FIRST TIME, READ THE FOLLOWING SECTION CAREFULLY: THE AVAILABLE POWER SUPPLY VOLTAGE DIFFERS AMONG COUNTRIES AND REGIONS. MAKE SURE THE POWER SUPPLY VOLTAGE OF THE AREA WHERE THIS UNIT WILL BE USED MEETS THE REQUIRED VOLTAGE (E.G., 230V OR 120V) WRITTEN ON THE REAR PANEL.

WARNING DO NOT PLACE NAKED FLAME SOURCES, SUCH AS LIT CANDLES, ON THE UNIT. NAKED FLAME SOURCES MIGHT ACCIDENTALLY FALL DOWN, CAUSING FIRE TO SPREAD OVER THE UNIT.

CAUTION LASER SAFETY: This unit employs a LASER. Only a qualified person should remove the cover or attempt to service this device, due to possible eye injury.

CAUTION

- Use of controls or adjustments or performance of procedures other than those specified herein may result in hazardous radiation exposure.
- The use of optical instruments with this product will increase eye hazard.

FOR CANADIAN MODEL:

This Class B digital apparatus complies with Canadian ICES-003.

POUR LE MODELE CANADIEN:

Cet appareil numérique de la Classe B est conforme à la norme NMB-003 due Canada.

ATTENTION:

POUR ÉVITER LES CHOCS ÉLECTRIQUES INTRODUIRE LA LAME LA PLUS LARGE DE LA FICHE DANS LA BORNE CORRESPONDANTE DE LA PRISE ET POUSSER JUSQU'AU FOND.

CAUTION

This product satisfies FCC regulations when shielded cables and connectors are used to connect the unit to other equipment. To prevent electromagnetic interference with electric appliances such as radios and televisions, use shielded cables and connectors for connections.

This equipment has been tested and found to comply with the limits for a Class B digital device, pursuant to Part 15 of the FCC Rules. These limits are designed to provide reasonable protection against harmful interference in a residential installation. This equipment generates, uses, and can radiate radio frequency energy and, if not installed and used in accordance with the instructions, may cause harmful interference to radio communications. However, there is no guarantee that interference will not occur in a particular installation. If this equipment does cause harmful interference to radio or television reception, which can be determined by turning the equipment off and on, the user is encouraged to try to correct the interference by one or more of the following measures:

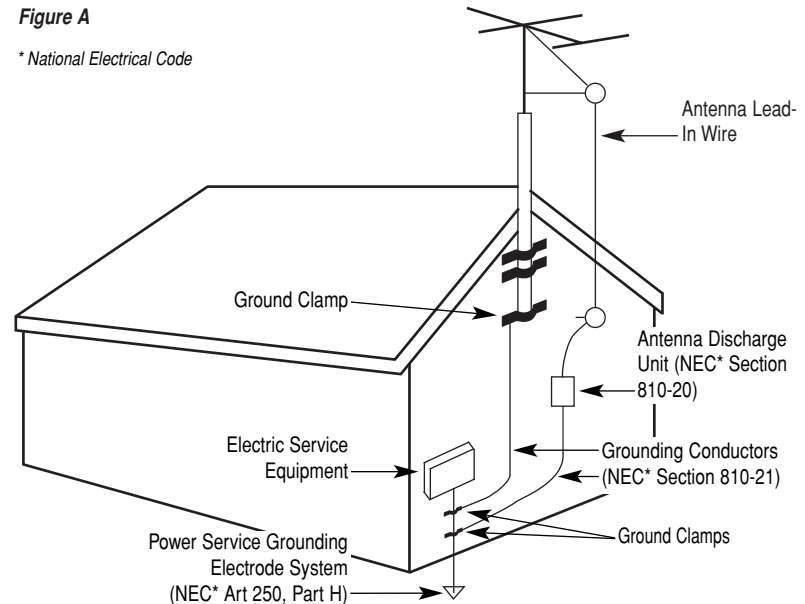
- Reorient or relocate the receiving antenna.
- Increase the separation between the equipment and receiver.
- Connect the equipment into an outlet on a circuit different from that to which the receiver is connected.
- Consult the dealer or an experienced radio/TV technician for help.

OUTDOOR ANTENNA GROUNDING

If an outside antenna or cable system is connected to the product, be sure the antenna or cable system is grounded so as to provide some protection against voltage surges and built-up static charges. Article 810 of the National Electrical Code, ANSI/NFPA 70, provides information with regard to proper grounding of the mast and supporting structure, grounding of the lead-in wire to an antenna discharge unit, size of grounding conductors, location of antenna-discharge unit, connection to grounding electrodes, and requirements for the grounding electrode. See Figure A below.

Figure A

* National Electrical Code



DOCUMENTATION CONVENTIONS

This document contains general safety, installation, and operation instructions for the RT-10 Universal Disc Player. It is important to read this user guide before operating this product. Pay particular attention to safety instructions.

The following symbols are used in this document:



Appears on your component to alert you to the presence of uninsulated, dangerous voltage inside the enclosure...voltage that may be sufficient to constitute a risk of shock.

WARNING

Calls attention to a procedure, practice, condition or the like that, if not correctly performed or adhered to, could result in injury or death.



Appears on your component to alert you to important operating and maintenance instructions in this accompanying literature.

CAUTION

Calls attention to a procedure, practice, condition or the like that, if not correctly performed or adhered to, could result in damage or destruction to part or all of the product.

Note:

Calls attention to information that is essential to highlight.

- This document uses the term "DVD" to refer to DVD-V, DVD-A, DVD-RW, and DVD-R formats. Otherwise, this document uses the term DVD-V to refer to DVD Video format, DVD-A to refer to DVD Audio format, and DVD-RW/R to refer to DVD-RW and DVD-R formats.
- This document uses the term "CD" to refer to Audio CD, CD-RW, CD-R, and Video CD formats. Otherwise, this document uses the term Audio CD to refer to Audio CD format, CD-RW/R to refer to CD-RW and CD-R formats, and Video CD to refer to Video CD format.
- This document uses the term "MP3" to refer to CD-RW/R formats that include MP3 tracks.

Lexicon

H A Harman International Company

Lexicon, Inc.
3 Oak Park
Bedford, MA 01730-1413 USA
Tel 781-280-0300
Fax 781-280-0490
www.lexicon.com

Customer Support

Tel 781-280-0300
Fax 781-280-0495 (Sales)
Fax 781-280-0499 (Service)

Lexicon Part No. 070-15658 | Rev 0 | 01/03

Manufactured under license from Dolby Laboratories. "Dolby," "Pro Logic," "Surround EX," and the double-D symbol are trademarks of Dolby Laboratories.

Manufactured under license from Digital Theater Systems, Inc. U.S. Pat. No. 5,451,942, 5,956,674, 5,974,380, 5,978,762, and other world-wide patents issued and pending. "DTS" and "DTS Digital Surround" are registered trademarks of Digital Theater Systems, Inc. © 1996, 2000 Digital Theater Systems, Inc. All rights reserved.

This product incorporates copyright protection technology that is protected by method claims of certain U.S. patents and other intellectual property rights owned by Macrovision Corporation and other rights owners. Use of this copyright protection technology must be authorized by Macrovision Corporation, and is intended for home and other limited viewing uses only unless otherwise authorized by Macrovision Corporation. Reverse engineering or disassembly is prohibited.

© 2003 Lexicon, Inc. All rights reserved.

This document should not be construed as a commitment on the part of Lexicon, Inc. The information it contains is subject to change without notice. Lexicon, Inc. assumes no responsibility for errors that may appear within this document.

Introduction

Documentation Conventions	iii
(US) Important Safety Instructions	vi
(DE) Wichtige Sicherheitshinweise	vi
(ES) Instrucciones de seguridad importantes	vii
(FR) Instructions importantes relatives à la sécurité	vii
(IT) Importanti norme di sicurezza	viii
(PT) Instruções Importantes de Segurança	viii
(DK) Vigtig information om sikkerhed	ix
(FI) Tärkeitä turvallisuusohjeita	ix
(NO) Viktig informasjon om sikkerhet	x
(SE) Viktiga säkerhetsföreskrifter	x
(US) Unpacking and Inspection	xi
(DE) Auspacken und Überprüfung	xi
(ES) Desembalaje e inspección	xi
(FR) Contenu de l'emballage et inspection	xi
(IT) Disimballaggio ed ispezione	xi
(PT) Retirando a embalagem e Inspeccionando	xi

Section 1: Getting Started

About the RT-10	1-2
<i>Highlights • Product Registration</i>	
Installation Considerations	1-3
<i>Do . . . • Do Not . . .</i>	
DVD-V Regions	1-4
Disc Compatibility	1-5
<i>Discs to Avoid</i>	
Disc Care & Handling	1-8
<i>Do . . . • Do Not . . .</i>	
Remote Control Battery Installation	1-9

Section 2: Basic Operation

Front Panel Overview	2-2
<i>Front Panel Display Indicators</i>	
Rear Panel Overview	2-8
<i>Rear Panel Connections</i>	
Remote Control Overview	2-14
<i>Operation Considerations • Command Matrix</i>	

Section 3: Setup Menus

Control Bar	3-2
Setup Navigator	3-2
Setup Menu	3-9
<i>Audio1 • Audio2 • Video1 • Video2 • Language • General</i>	
Setup Menu Shortcuts	3-50
Advanced Setup Menu	3-51

Section 4: Playback Controls

Playback Icons	4-2
Loading Discs	4-2
Navigating Disc Menus	4-3
Selecting Disc Settings	4-7
<i>Audio Tracks • Subtitle Languages • Camera Angles • Storing Disc Settings</i>	
Playback Modes	4-11
<i>Playback • Last Memory Playback • Stop Mode • Resume Mode • Pause Mode • Still Frame Playback • Frame-by-Frame Playback • Slow Playback • Random Playback • Repeat Playback • A-B Repeat Playback • Program Mode • Search Mode • Display Mode</i>	

Section 5: Troubleshooting & Maintenance

Troubleshooting	5-2
<i>Power Issues • Remote Control Issues • Video Output Issues • Audio Output Issues • Playback Issues • Setup Menu Issues • Playback Control Issues • Miscellaneous Issues</i>	
RT-10 Maintenance	5-15
Disc Maintenance	5-16
Restoring Factory-Default Settings	5-16

Appendix

Specifications	A-2
Declaration of Conformity	A-3
Setup Menu Screens	A-4
Table of Languages & Language Codes	A-14
Table of Country Codes	A-16
Installation Worksheet	A-17

Index	I-1
------------------------	-----

Notes

Limited Warranty	Inside Back Cover
-----------------------------------	-------------------



ENGLISH
IMPORTANT SAFETY INSTRUCTIONS



- Save these instructions for later use.
- Follow all instructions and warnings marked on the unit.
- Always use with the correct line voltage. Refer to the manufacturer's operating instructions for power requirements. Be advised that different operating voltages may require the use of a different line cord and/or attachment plug.
- Do not install the unit in an unventilated rack, or directly above heat producing equipment such as power amplifiers. Observe the maximum ambient operating temperature listed in the product specification.
- Slots and openings on the case are provided for ventilation; to ensure reliable operation and prevent it from overheating, these openings must not be blocked or covered. Never push objects of any kind through any of the ventilation slots. Never spill liquid of any kind on the unit.
- Never attach audio power amplifier outputs directly to any of the unit's connectors.
- To prevent shock or fire hazard, do not expose the unit to rain or moisture, or operate it where it will be exposed to water.
- Do not attempt to operate the unit if it has been dropped, damaged, exposed to liquids, or if it exhibits a distinct change in performance indicating the need for service.
- This unit should only be opened by qualified service personnel. Removing covers will expose you to hazardous voltages.



This triangle, which appears on your component, alerts you to the presence of uninsulated, dangerous voltage inside the enclosure...voltage that may be sufficient to constitute a risk of shock.



This triangle, which appears on your component, alerts you to important operating and maintenance instructions in this accompanying literature.



DEUTSCH
WICHTIGE SICHERHEITSHINWEISE



- Bewahren Sie diese Anleitungen zur späteren Benutzung auf.
- Befolgen Sie alle Anleitungen und alle Warnhinweise auf dem Gerät
- Betreiben Sie das Gerät immer mit der korrekten Netzspannung. Angaben über den Strombedarf entnehmen Sie bitte den Betriebsanweisungen des Herstellers. Bei unterschiedlichen Betriebsspannungen kann die Verwendung anderer Netzkabel und/oder Anschlußstecker erforderlich werden.
- Bauen Sie das Gerät nie in ein unbelüftetes Rack oder direkt über Wärme erzeugenden Geräten wie Verstärkern ein. Beachten Sie die in der Produktspezifikation aufgeführte maximale Umgebungstemperatur für den Betrieb.
- Schlitze und Öffnungen in der Box dienen der Belüftung, damit das Gerät zuverlässig läuft und sich nicht überhitzt. Diese Öffnungen dürfen nicht abgedeckt oder blockiert werden. Auch dürfen keine Gegenstände in sie hineingesteckt werden. Verschütten Sie niemals Flüssigkeiten, gleich welcher Art, auf das Gerät.
- Schließen Sie niemals Stromausgänge des Audioverstärkers direkt an das Gerät an.
- Zur Vermeidung von elektrischen Schlägen oder Brandgefahr darf das Gerät weder Regen noch Feuchtigkeit ausgesetzt oder an Orten betrieben werden, wo es mit Wasser in Berührung kommen kann.
- Versuchen Sie nie, das Gerät zu betreiben, wenn es fallen gelassen, beschädigt oder Flüssigkeiten ausgesetzt wurde oder wenn ein deutlicher Leistungsunterschied zu verzeichnen ist, der darauf hinweist, dass es gewartet werden muss.
- Dieser Apparat sollte nur von qualifizierten Fachleuten geöffnet werden. Das Abnehmen von Abdeckungen setzt Sie gefährlichen Spannungen aus.



Dieses Dreieck, welches auf Ihrem Bauteil angebracht ist, warnt Sie vor dem Vorhandensein nicht isolierter gefährlicher Spannung im Gerät. Diese Spannung kann so hoch sein, dass das Risiko eines Stromschlags besteht.



Dieses Dreieck, welches auf Ihrem Bauteil angebracht ist, macht Sie auf wichtige Betriebs- und Wartungshinweise in diesen Hinweisen aufmerksam.



ESPAÑOL



INSTRUCCIONES DE SEGURIDAD IMPORTANTES

- Guarde estas instrucciones para futuras referencias.
- Siga todas las instrucciones y tenga en cuenta las advertencias que aparecen en la unidad y en las instrucciones de funcionamiento.
- Utilice siempre la tensión de línea correcta. Consulte las instrucciones del fabricante, donde se especifican los requisitos de alimentación. Tenga en cuenta que unas tensiones operativas diferentes pueden precisar de la utilización de diferentes cables de alimentación y/o enchufes.
- No instale la unidad en un rack sin ventilación, o directamente sobre equipos que generen calor, como amplificadores de potencia. Tenga en cuenta la temperatura operativa ambiental máxima que se detalla en las especificaciones del producto.
- Las ranuras y aberturas del equipo son para su ventilación - para garantizar un funcionamiento fiable y evitar que la unidad se sobrecaliente, no bloquee, cubra o inserte objetos en las aberturas. No derrame nunca líquidos de ningún tipo sobre la unidad.
- Nunca conecte directamente salidas de amplificadores de potencia de audio a ninguno de los conectores de la unidad.
- Para evitar descargas eléctricas o incendios, no exponga la unidad a la humedad o la lluvia, ni la utilice donde pueda estar expuesta al agua.
- No intente utilizar la unidad si ésta ha caído, se ha dañado, ha estado expuesta a líquidos, o si muestra un cambio importante en sus prestaciones, lo cual indicaría la necesidad de una reparación.
- Dieser Apparat sollte nur von qualifizierten Fachleuten geöffnet werden. Das Esta unidad deberá ser abierta únicamente por personal calificado. Si usted quita las coberturas se expondrá a voltajes peligrosos.



Este tri ngulo, que aparece en su componente, alerta de la presencia de una tensi n peligrosa no aislada en el interior del equipo - una tensi n que puede ser suficiente como para constituir un riesgo de descarga elctrica.



Este tri ngulo, que aparece en su equipo, le alerta de instrucciones operativas y de mantenimiento importantes en los documentos que acompa an el producto.



FRANÇAIS



INSTRUCTIONS IMPORTANTES RELATIVES À LA SÉCURITÉ

- Conservez ces instructions pour pouvoir vous y référer ultérieurement.
- Suivez toutes ces instructions et tenez compte de tous les avertissements indiqués sur l'appareil et dans la documentation fournie avec l'appareil.
- Utilisez toujours la tension secteur correcte. Consultez les instructions du fabricant précisant les caractéristiques d'alimentation à respecter. Attention, le type de cordon secteur et/ou de prise secteur peut varier selon des tensions en vigueur dans l'installation.
- N'installez pas l'appareil dans un Rack mal ventilé ou directement au-dessus d'un appareil dégageant de la chaleur comme un amplificateur de puissance. Respectez la température maximale de fonctionnement précisée dans les caractéristiques techniques.
- Les ouvertures dans le boîtier assurent la bonne ventilation de l'appareil, évitent toute surchauffe et assurent le bon fonctionnement du système. Veillez à ne pas obstruer, couvrir ou insérer d'objets dans ces ouvertures. Veillez à ne pas renverser de liquide sur l'appareil.
- Ne reliez jamais directement les sorties audio des amplificateurs de puissance aux connecteurs de l'appareil.
- Afin d'éviter tout risque d'électrocution ou d'incendie, n'exposez pas l'appareil à la pluie ou à l'humidité ; ne l'utilisez pas dans des endroits exposés aux projections de liquides.
- N'essayez pas d'utiliser l'appareil si celui-ci est tombé, a été endommagé, exposé à des projections de liquides ou si vous constatez des dysfonctionnements nécessitant l'intervention d'un technicien spécialisé.
- Cet appareil ne doit être ouvert que par un personnel de service qualifié. En enlevant les couvercles vous vous exposez à des tensions électriques dangereuses.



Le symbole de l'clair fl ch dans un triangle quilat ral sert alerter l'utilisateur sur la pr sence l'int rieur de l'appareil de tensions non isol es susceptibles de constituer un risque d'lectrocution.



Le point d'exclamation dans un triangle quilat ral sert alerter l'utilisateur sur la pr sence de nombreuses instructions de maintenance dans le manuel fourni avec l'appareil.

IT

ITALIANO

IMPORTANTI NORME DI SICUREZZA

IT

- Conservare le presenti norme per l'utilizzo futuro.
- Seguire sempre tutte le istruzioni e gli avvertimenti segnati sull'unità e nelle istruzioni operative.
- Utilizzare sempre la corretta tensione di alimentazione. Fare riferimento al manuale del costruttore per le caratteristiche di alimentazione. Tensioni di rete diverse necessitano anche di un diverso cavo con spine differenti.
- Non installare l'unità in un rack poco ventilato, o direttamente sopra apparecchiature che producono calore, come amplificatori di potenza. Controllare la massima temperatura ambientale di esercizio sulle specifiche tecniche del prodotto.
- Fori ed aperture nei pannelli sono necessari per garantire un corretta ventilazione e prevenire surriscaldamenti. Queste aperture non devono essere coperte o ostruite. Non inserire oggetti di alcun tipo nei fori di ventilazione. Evitare il contatto con liquidi di qualsiasi genere.
- Evitare di collegare le uscite di un amplificatore di potenza direttamente a qualsiasi connettore dell'unità.
- Per evitare il rischio di scosse elettriche non esporre il prodotto a pioggia o umidità. Evitare l'uso dove possa essere esposto all'acqua.
- Non tentare di utilizzare il prodotto se è caduto, se è stato a contatto con liquidi, o mostra chiari segni di danneggiamento o cambio di prestazioni che indicano la necessità di assistenza tecnica.
- Ogni intervento sull'unità va eseguito esclusivamente da personale qualificato. La rimozione della copertura comporta l'esposizione al pericolo di folgorazione.



Il presente triangolo impresso sul componente avverte la presenza di tensioni pericolose non isolate all'interno della copertura – tali tensioni rappresentano un pericolo di folgorazione.



Il presente triangolo impresso sul componente avverte l'utente della presenza nella documentazione allegata di importanti istruzioni relative al funzionamento ed alla manutenzione.

PT

PORTUGUESE

INSTRUÇÕES IMPORTANTES DE SEGURANÇA

PT

- Guarde essas instruções para uso posterior.
- Siga todas as instruções e fique atento aos avisos marcados na unidade e nas instruções de operação.
- Sempre use com a voltagem correta. Veja no manual de instruções do fabricante qual a alimentação necessária. Lembre-se que voltagens de operação diferentes podem precisar de um cabo ou plug diferentes.
- Não instale a unidade em um suporte sem ventilação ou diretamente acima de equipamentos que produzem calor, como transformadores. Observe a temperatura ambiente máxima de operação indicada na especificação do produto.
- O revestimento da unidade é provido de fendas e aberturas para ventilação – para assegurar uma operação confiável e evitar que a unidade se supraqueça. Não bloqueie, cubra ou insira objetos nas aberturas. Nunca derrube líquido de qualquer espécie na unidade.
- Nunca ligue saídas de amplificadores de áudio diretamente a qualquer dos conectores da unidade.
- Para evitar danos de choque ou fogo, não exponha a unidade à chuva ou umidade, ou opere-a onde haja exposição à água.
- Não tente operar a unidade se ela for derrubada, danificada, exposta à líquidos ou apresente uma mudança de performance notável, indicando a necessidade de manutenção.
- Esta unidade só deveria ser aberta através de pessoal de serviço qualificado. Removendo coberturas o exporão a voltagens perigosas.



Esse triângulo que aparece no seu console, alerta para a presença de voltagem perigosa e não isolada no recinto – voltagem que pode ser suficiente para constituir um risco de choque.



Esse triângulo que aparece no seu console alerta para instruções importantes de operação e manutenção neste manual.

DK

DANSK

DK

VIGTIG INFORMATION OM SIKKERHED

- Gem denne vejledning til senere brug.
- Følg alle anvisninger og advarsler på apparatet.
- Apparatet skal altid tilsluttes den korrekte spænding. Der henvises til brugsanvisningen, der indeholder specifikationer for strømforsyning. Der gøres opmærksom på, at ved varierende driftsspændinger kan det blive nødvendigt at bruge andre lednings- og/eller stiktyper.
- Apparatet må ikke monteres i et kabinet uden ventilation eller lige over andet udstyr, der udvikler varme, f.eks. forstærkere. Den maksimale omgivelsestemperatur ved drift, der står opført i specifikationerne, skal overholdes.
- Der er ventilationsåbninger i kabinettet. For at sikre apparatets drift og hindre overophedning må disse åbninger ikke blokeres eller tildækkes. Stik aldrig noget ind igennem ventilationsåbningerne, og pas på aldrig at spilde nogen form for væske på apparatet.
- Udgangsstik fra audioforstærkere må aldrig sættes direkte i apparatet.
- Apparatet må ikke udsættes for regn eller fugt og må ikke bruges i nærheden af vand for at undgå risiko for elektrisk stød og brand.
- Apparatet må aldrig bruges, hvis det er blevet stødt, beskadiget eller vådt, eller hvis ændringer i ydelsen tyder på, at det trænger til eftersyn.
- Dette apparat må kun åbnes af fagfolk. Hvis dækslet tages af, udsættes man for livsfarlig højspænding.



Denne mærkat på komponenten advarer om uisoleret, farlig spænding i apparatet - høj nok til at give elektrisk stød.



Denne mærkat på komponenten advarer om vigtig driftsog vedligeholdelsesinformation i den tilhørende litteratur.

FI

SUOMI

FI

TÄRKEITÄ TURVALLISUUSOHJEITA

- Säilytä nämä ohjeet tulevaa käyttöä varten.
- Seuraa kaikkia yksikköön merkittyjä ohjeita ja varoituksia.
- Käytä aina oikeaa verkkojännitettä. Tehovaatimukset selviävät valmistajan käyttöohjeista. Huomaa, että eri käyttöjännitteet saattavat vaatia toisenlaisen verkkojohdon ja/tai -pistokkeen käytön.
- Älä asenna yksikköä telineeseen jossa ei ole tuuletusta, tai välittömästi lämpöä tuottavien laitteiden, esim. tehovahvistimien, yläpuolelle. Ympäristön lämpötila käytössä ei saa ylittää tuotespesifikaation maksimilämpötilaa.
- Kotelo on varustettu tuuletusreiillä ja -aukoilla. Luotettavan toiminnan varmistamiseksi ja ylläpölyntien välttämiseksi näitä aukkoja ei saa sulkea tai peittää. Mitään esineitä ei saa työntää tuuletusaukoihin. Mitään nesteitä ei saa kaataa yksikköön.
- Älä kytke audiotehovahvistimen lähtöjä suoraan mihinkään yksikön liittimeen.
- Sähköiskun ja palovaaran välttämiseksi yksikkö ei saa olla sateessa tai kosteassa, eikä sitä saa käyttää märässä ympäristössä.
- Älä käytä yksikköä jos se on pudonnut, vaurioitunut, kostunut, tai jos sen suorituskyky on huomattavasti muuttunut, mikä vaatii huoltoa.
- Yksikön saa avata vain laitteeseen perehtynyt huoltohenkilö. Kansien poisto altistaa sinut vaarallisille jännitteille.



Tämä kolmio, joka esiintyy komponentissasi, varoittaa sinua eristämättömän vaarallisen jännitteen esiintymisestä yksikön sisällä. Tämä jännite saattaa olla riittävän korkea aiheuttamaan sähköiskuvaaran.



Tämä kolmio, joka esiintyy komponentissasi, kertoo sinulle, että tässä tuotedokumentoinnissa esiintyy tärkeitä käyttö- ja ylläpito-ohjeita.



NORSK

VIKTIG INFORMASJON OM SIKKERHET



- Ta vare på denne veiledningen for senere bruk.
- Følg alle anvisningene og advarslene som er angitt på apparatet.
- Apparatet skal alltid anvendes med korrekt spenning. Produktbeskrivelsen inneholder spesifikasjoner for strømkrav. Vær oppmerksom på at det ved ulike driftsspenninger kan være nødvendig å bruke en annen ledning- og/eller støpseltype.
- Apparatet skal ikke monteres i skap uten ventilasjon, eller direkte over varmeproduserende utstyr, som for eksempel kraftforstærkere. Den maksimale romtemperaturen som står oppgitt i produktbeskrivelsen, skal overholdes.
- Apparatet er utstyrt med ventilasjonsåpninger. For at apparatet skal være pålitelig i bruk og ikke veropphetes, må disse åpningene ikke blokkeres eller tildekkes. Stikk aldri noe inn i ventilasjonsåpningene, og pass på at det aldri søles noen form for væske på apparatet.
- Utgangsplugger fra audioforstærkere skal aldri koples direkte til apparatet.
- Unngå brannfare og elektrisk støt ved å sørge for at apparatet ikke utsettes for regn eller fuktighet og ikke anvendes i nærheten av vann.
- Apparatet skal ikke brukes hvis det har blitt utsatt for støt, er skadet eller blitt vått, eller hvis endringer i ytelsen tyder på at det trenger service.
- Dette apparatet skal kun åpnes av fagfolk. Hvis dekslet fjernes, utsettes man for livsfarlig høyspenning.



Komponenten er merket med denne trekanten, som er en advarsel om at det finnes isolert, farlig spenning inne i kabinettet - høy nok til å utgjøre en fare for elektrisk støt.



Komponenten er merket med denne trekanten, som betyr at den tilhørende litteraturen inneholder viktige opplysninger om drift og ved.



SVENSKA

VIKTIGA SÄKERHETSFORESKRIFTER



- Spara dessa föreskrifter för framtida bruk.
- Följ alla anvisningar och varningar som anges på enheten.
- Använd alltid rätt nätspänning. Se tillverkarens bruksanvisningar för information om effektkrav. Märkväl, att andra matningsspänningar eventuellt kräver att en annan typs nätsladd och/eller kontakt används.
- Installera inte enheten i ett oventilerat stativ, eller direkt ovanför utrustningar som avger värme, t ex effektförstärkare. Se till att omgivningens temperatur vid drift inte överskrider det angivna värdet i produktspecifikationen.
- Behållaren är försedd med hål och öppningar för ventilering. För att garantera tillförlitlig funktion och förhindra överhettning får dessa öppningar inte blockeras eller täckas. Inga föremål får skuffas in genom ventilationshålen. Inga vätskor får spillas på enheten.
- Anslut aldrig audioeffektförstärkarutgångar direkt till någon av enhetens kontakter.
- För att undvika elstöt eller brandfara får enheten inte utsättas för regn eller fukt, eller användas på ställen där den blir våt.
- Använd inte enheten om den har fallit i golvet, skadats, blivit våt, eller om dess prestanda förändrats märkbart, vilket kräver service.
- Enheten får öppnas endast av behörig servicepersonal. Farliga spänningar blir tillgängliga när locken tas bort.



Denna triangel, som visas på din komponent, varnar dig om en isolerad farlig spänning inne i enheten. Denna spänning är eventuellt så hög att fara för elstöt föreligger.



Denna triangel, som visas på din komponent, anger att viktiga bruksanvisningar och serviceanvisningar ingår i dokumentationen i fråga.

US Unpacking and Inspection

After unpacking the unit, save all packing materials in case the unit ever needs to be shipped. Thoroughly inspect the modules and packing materials for signs of damage. Report any damage to the carrier at once; report equipment malfunction to the dealer.

DE Auspacken und Überprüfung

Bewahren Sie nach dem Auspacken des Geräts das Verpackungsmaterial für den Fall auf, dass Sie das Gerät wieder versenden müssen. Überprüfen Sie die Module und die Verpackung sorgfältig auf Anzeichen von Beschädigung. Etwaige Schäden sind dem Transporteur unverzüglich anzuzeigen; Funktionsstörungen sind dem zuständigen Händler zu melden.

ES Desembalaje e inspección

Después de desembalar la unidad, guarde todos los materiales de embalaje por si alguna vez transportar la unidad. Inspeccione con atención los módulos y los materiales de embalaje para comprobar que no muestren desperfectos. Informe inmediatamente de cualquier desperfecto al transportista; informe de cualquier problema de funcionamiento del equipo a su distribuidor.

FR Contenu de l'emballage et inspection

Après avoir ouvert l'emballage, conservez-le pour tout retour. Inspectez avec soin les modules et les matériaux d'emballage pour tout signe de dommage. Veuillez rapporter immédiatement les dommages auprès du transporteur. Les dysfonctionnements du matériel doivent être signalés à votre revendeur.

IT Disimballaggio ed ispezione

Dopo aver disimballato l'unità, salvi tutto il materiale d'imballaggio, in caso Lei abbia bisogno di spedire l'unità. Ispezioni attentamente i moduli ed il materiale d'imballaggio per vedere se riportano segni di danno. Riporti subito ogni segno di danno al corriere; riferisca il malfunzionamento dell'attrezzatura al suo rivenditore.

PT Retirando a embalagem e Inspeccionando

Depois de desembalar a unidade, guarde a embalagem caso precise enviar a unidade para manutenção. Inspeção cuidadosamente o módulo e a embalagem procurando sinais de dano. Avise à loja qualquer tipo de dano ou mal funcionamento do equipamento.

Getting Started

About the RT-10	1-2
<i>Highlights • Product Registration</i>	
Installation Considerations.	1-3
<i>Do . . . • Do Not . . .</i>	
DVD-V Regions	1-4
Disc Compatibility.	1-5
<i>Discs to Avoid</i>	
Disc Care & Handling	1-8
<i>Do . . . • Do Not . . .</i>	
Remote Control Battery Installation	1-9

ABOUT THE RT-10

Thank you for purchasing the RT-10 Disc Player, a reference-quality universal disc transport designed to provide superior audio and video performance with virtually any 3- or 5-inch optical media disc format. Based on leading-edge DVD and SACD research, the RT-10 supports DVD-V, DVD-A, DVD-RW/R, SACD, Audio CD, CD-RW/R, Video CD, and SVCD formats. It delivers exceptional sound quality with Dolby Digital, DTS, and PCM (Linear or Packed) digital audio sources. In addition, it supports most MPEG video and MP3 audio sources.

With rear panel connectors befitting a reference-quality player, the RT-10 includes the standard composite and S-video output connectors, as well as progressive-scan component video output on RCA or professional-grade BNC connectors. High-precision 12-bit/108MHz D/A converters provide a pristine video image without degradation during analog conversion. Progressive-scan component video output converts interlaced video signals to progressive video signals, doubling the amount of video information sent to a compatible display device. The result is a higher quality, more stable image with fewer video artifacts.

Video Adjust allows for exact, detailed adjustment of video settings such as Pure Cinema, sharpness, white, black, gamma, hue, and chroma levels, as well as luminance (YNR), chrominance (CNR), mosquito (MNR), and black (BNR) noise reduction. Pure Cinema automatically converts film sources recorded at 24 frames-per-second to 60 frames-per-second to create a more natural picture. The RT-10 offers six banks of Video Adjust settings, including three preset banks for CRT, plasma, and professional display devices and three memory banks for storage of user-defined Video Adjust settings.

Digital audio sources are available on S/PDIF or analog audio output connectors. Three digital audio output connectors – one S/PDIF coaxial, one S/PDIF optical, and one AES/EBU – allow for external decoding and processing of Dolby Digital, DTS, and PCM (Linear or Packed) sources. Alternatively, built-in 24-bit/192kHz D/A converters on all six analog audio output connectors allow high-bandwidth formats such as DVD-A and SACD to deliver smooth, expansive analog sound without sample rate conversion and digital word length reduction.

Setup is simplified with color on-screen display menus that can be customized for the desired level of control. The Setup Navigator provides step-by-step guidance through the process of configuring minimum settings. When activated, it presents a series of questions that, when answered, allow the RT-10 to implement the correct audio, video, and language settings.

The Setup menu provides access to more advanced controls. Available in basic and expert display modes, the Setup menu can be customized to include controls that are required to configure the most common settings or to include all controls that are available. In addition, the RT-10 allows the creation of up to five shortcuts, which provide convenient access to frequently adjusted controls without navigating through the entire Setup menu.

Built to Lexicon standards, the RT-10 represents a solid investment that promises to complement the finest home theaters. With its extensive compatibility, the RT-10 is sure to deliver exceptional performance whether watching the latest blockbuster on DVD or listening to a remix of an old favorite on SACD. Even the most demanding enthusiast will be impressed with its unbeatable combination of technology, flexibility, and simplicity.

HIGHLIGHTS

- DVD-V, DVD-A, and DVD-RW/R compatibility
- SACD compatibility
- Audio CD, CD-RW/R, Video CD, and SVCD compatibility
- 12-bit/108MHz D/A video conversion
- Progressive-scan component video output on BNC, RCA, or Mini-D Ribbon connectors
- True 3:2 pull-down for the finest film-based DVD reproduction
- Video Adjust for exact, detailed adjustment of video settings
- Six Video Adjust banks, including three preset banks and three memory banks for user-defined settings
- 24-bit/192kHz D/A audio conversion
- Digital audio output on S/PDIF coaxial, S/PDIF optical, or AES/EBU connectors
- Still Frame, Frame-by-Frame, Slow, Random, Repeat, and Program playback modes
- Shortcuts for up to 5 frequently adjusted controls
- Stored disc settings for up to 15 discs
- MP3 and MPEG compatibility
- Composite and S-video output
- Video and audio output on Euro or Peritel (TV A/V) connector
- Trigger input connector
- IR input connector
- Intuitive, customizable user-interface
- Setup Navigator
- Optional 19-inch rack mount kit

PRODUCT REGISTRATION

Please register the RT-10 within 15 days of purchase. To do so, register on-line at www.lexicon.com or complete and return the Product Registration card attached to the back cover of this user guide. Product registration serves no warranty purposes. Retain the sales receipt as proof of warranty coverage.

INSTALLATION CONSIDERATIONS

The RT-10 requires special care during installation to ensure optimal performance. Pay particular attention to the bulleted items that begin below and to other precautions that appear throughout this user guide.

CAUTION

Before moving the RT-10, make sure the disc drawer is empty and the RT-10 is powered off with the front panel On/Off button. Then, make sure the power cord is disconnected from the wall outlet and that other cables are disconnected from associated components.

Never lift or move the RT-10 during playback. Discs rotate at high speeds inside the player. Movement might damage the disc and the player.

DO . . .

- Install the RT-10 on a solid, flat, level surface such as a table or shelf or in a standard 19-inch equipment rack. An optional rack-mount kit is available from authorized Lexicon dealers.
- Select a dry, well-ventilated location out of direct sunlight.

. . . *Installation Considerations continues on page 1-4*

Installation Considerations (continued from page 1-3)**DO NOT . . .**

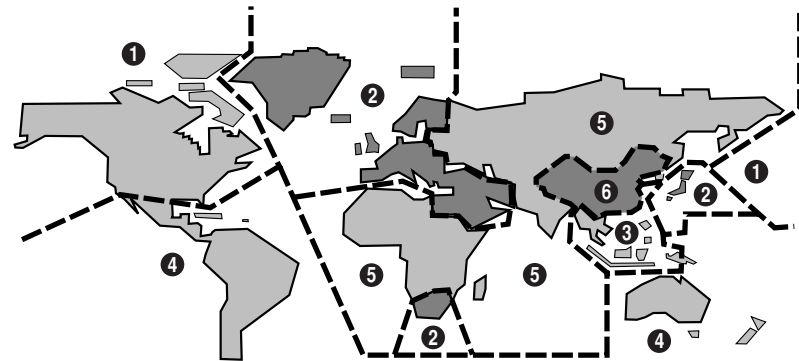
- Install the RT-10 on a surface that is unstable or unable to support all four of its feet (unless the RT-10 is installed in an equipment rack).
- Stack the RT-10 directly above heat-producing components such as power amplifiers and other stereo equipment that generate heat during use. Avoid installing the RT-10 near radiators and other heat-producing appliances.
- Expose the RT-10 to high temperatures, direct sunlight, humidity, steam, smoke, dampness, and excessive dust.
- Install the RT-10 near unshielded TV or FM antennas, cable TV decoders, and other RF emitting devices that might cause interference. Replace unshielded cables with shielded cables whenever possible.
- Prevent proper cooling. Do not block or cover ventilation slots and openings on the RT-10 with items such as newspapers, cloths, and curtains. Do not place the RT-10 on a thick carpet, bed, sofa, or fabric with a thick pile.
- Expose the RT-10 to sudden or drastic temperature changes, as this might cause condensation to form on the RT-10 lens. Although condensation will not damage the RT-10, it might temporarily impair performance. If this occurs, allow at least 1 hour for condensation to evaporate before attempting to load a disc.
- Obstruct the front panel display remote control sensor when the RT-10 is not using the IR input connector. If the RT-10 is not using the IR IN connector, the remote control must be in line-of-sight with the front panel display remote control sensor. Refer to page 2-14 for more information.

Note:

The RT-10 lens should not become dirty or damaged from regular use. However, if malfunction occurs, contact an authorized Lexicon dealer for assistance. Do not attempt to clean the lens with a commercially available DVD or CD lens cleaner, as some of these products might damage the RT-10 lens.

DVD-V REGIONS

The map shown below indicates DVD-V region codes for all areas of the world. All DVD-Vs are marked with a region code, which is often located on the disc packaging. The RT-10 rear panel is also marked with a region code. The RT-10 is compatible with discs marked with this same region code or with the ALL region code. The RT-10 is not compatible with discs marked with other region codes.







DISC COMPATIBILITY

The RT-10 is compatible with disc formats that meet the requirements listed in the tables that begin below. Refer to the Disc Care & Handling section (1-8), the Loading Discs section (4-2), and the Disc Maintenance section (5-16) for more information.





Note:

The RT-10 is not compatible with DVD-ROM, DVD-RAM, CD-ROM (except those that include compatible MP3 tracks), and Photo CD formats.





Format	Logo	Disc Compatibility Requirements	Additional Information
DVD-V	 	<p>The RT-10 supports:</p> <ul style="list-style-type: none"> • 5-inch (12cm) or 3-inch (8cm) discs • Dolby Digital, DTS, MPEG, or PCM (Linear) digital audio • MPEG-2 video • Single- or double-sided discs • Single- or dual-layered discs 	<ul style="list-style-type: none"> • Discs are divided into titles, which are further divided into chapters.
DVD-A	 	<p>The RT-10 supports:</p> <ul style="list-style-type: none"> • 5-inch (12cm) or 3-inch (8cm) discs • Linear or PCM (Packed) digital audio (discs might also include Dolby Digital, DTS, or MPEG digital audio and MPEG-2 video) • MPEG-2 video • Single- or double-sided discs • Single- or dual-layered discs 	<ul style="list-style-type: none"> • Discs are divided into groups, which are further divided into tracks.

... Disc Compatibility continues on page 1-6

Disc Compatibility (continued from page 1-5)

Format	Logo	Disc Compatibility Requirements	Additional Information
DVD-RW/R		<p>The RT-10 supports:</p> <ul style="list-style-type: none"> • 5-inch (12cm) or 3-inch (8cm) discs • Discs recorded in DVD-V format <p>The RT-10 does not support:</p> <ul style="list-style-type: none"> • Unfinalized discs • Discs that include MP3 tracks • Copy-once protected discs* 	<ul style="list-style-type: none"> • The RT-10 might not allow playback of DVD-RW/Rs recorded with a personal computer if incorrect software application settings were used during the recording process – even if the disc was recorded in a compatible format. Refer to the software application documentation for more information.
SACD		<p>The RT-10 supports:</p> <ul style="list-style-type: none"> • 5-inch (12cm) or 3-inch (8cm) discs • Digital audio (DSD) • Single-, dual-, or hybrid-layered discs 	<ul style="list-style-type: none"> • Discs are divided into tracks.
Audio CD		<p>The RT-10 supports:</p> <ul style="list-style-type: none"> • 5-inch (12cm) or 3-inch (8cm) discs • PCM (Linear) digital audio 	<ul style="list-style-type: none"> • Discs are divided into tracks.
CD-RW/R		<p>The RT-10 supports:</p> <ul style="list-style-type: none"> • 5-inch (12cm) or 3-inch (8cm) discs • Discs recorded in Video CD or Audio CD format • Discs that include MP3 audio tracks that meet the requirements outlined in the table on the next page • Discs that are unfinalized, although some time information (i.e. playback time) will not display 	<ul style="list-style-type: none"> • The RT-10 might not allow playback of CD-RW/Rs recorded with a personal computer if incorrect software application settings were used during the recording process – even if the disc was recorded in a compatible format. Refer to the software application documentation for more information.

* When a copy-once protected disc is loaded, the message "COPY PROTECT PROGRAM. UNPLAYABLE." appears on the on-screen and front panel displays.

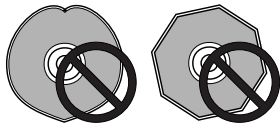
Format	Logo	Disc Compatibility Requirements	Additional Information
Video CD		<p>The RT-10 supports:</p> <ul style="list-style-type: none"> • 5-inch (12cm) or 3-inch (8cm) discs • MPEG-1 digital audio and MPEG-2 video 	<ul style="list-style-type: none"> • Discs are divided into tracks.
SVCD		<p>The RT-10 supports:</p> <ul style="list-style-type: none"> • 5-inch (12cm) or 3-inch (8cm) discs • PCM (Linear) digital audio 	<ul style="list-style-type: none"> • Discs are divided into tracks.
MP3	 	<p>The RT-10 supports:</p> <ul style="list-style-type: none"> • MP3 tracks recorded on a 5-inch (12cm) or 3-inch (8cm) CD-RW/R that is ISO 9660 compatible. The disc can be finalized or unfinalized, although some time information (i.e. playback time) will not display when an unfinalized disc is loaded. • MP3 tracks recorded in MPEG-1 Audio Layer 3 format with a 44.1 or 48kHz sample rate. • MP3 tracks that are named with a .mp3 or .MP3 extension. The first eight characters of folder and track names – excluding the extension – appear on the on-screen and front panel displays. <p>The RT-10 does not support:</p> <ul style="list-style-type: none"> • MP3 tracks that do not meet ALL of the requirements listed above. • MP3 tracks recorded on DVD-RW/Rs. 	<ul style="list-style-type: none"> • The RT-10 supports MP3 tracks encoded at less than 128kBps. However, sound quality will be impaired when playback of these tracks is in progress. • The RT-10 recognizes a maximum of 250 folders per disc and 250 tracks per folder. It ignores all folders and tracks that exceed this number. • The RT-10 does not support multi-session discs. It recognizes the first session recorded on the disc and ignores all other sessions. • The RT-10 supports some VBR (Variable Bit Rate) tracks, although some time information (i.e. playback time) will not display when playback of a VBR track is in progress. • Refer to page 4-11 for information about MP3 playback.

... Disc Compatibility continues on page 1-8

Disc Compatibility (continued from page 1-7)

DISCS TO AVOID

The RT-10 is compatible with 5-inch (12cm) and 3-inch (8cm) conventional, round discs. Do not attempt to load discs with other size and shape characteristics, such as those shown below. All discs must align with the circular guide inside the disc drawer.

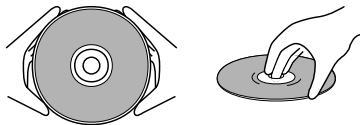


DISC CARE & HANDLING

Discs require special care and handling to ensure optimal performance. Pay particular attention to the bulleted items that begin at the top of the next column and to other precautions that appear throughout this user guide. In particular, refer to the Disc Compatibility section (1-5), the Loading Discs section (4-2), and the Disc Maintenance section (5-16).

DO . . .

- Hold discs at their center hole and outer edges as shown below. Take care not to leave fingerprints, dirt, and scratches on the disc surfaces.



- Load single-sided discs with the label side facing upward and double-sided discs with the side intended for playback facing downward. All loaded discs must align with the circular guide inside the disc drawer.
- Return discs to their cases when not in use. Discs should be stored in an upright position out of direct sunlight and excessive heat, humidity, or cold.

DO NOT . . .

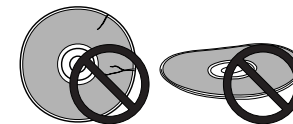
- Write on disc labels or surfaces with ballpoint pens, pencils, and other sharp-tipped writing instruments. Do not glue paper or attach stickers to discs as shown below. Although not as fragile as the recorded side, damage to the label side of the disc can still render the disc unplayable.



CAUTION

The RT-10 is a single-disc player. Do not attempt to insert more than one disc in the disc drawer at one time. This might cause damage to the RT-10, the discs, or both.

Dirty or damaged discs such as those shown below might affect playback performance or damage the RT-10. Do not attempt to load cracked, chipped, scratched, warped, dirty, or otherwise damaged discs in the disc drawer.



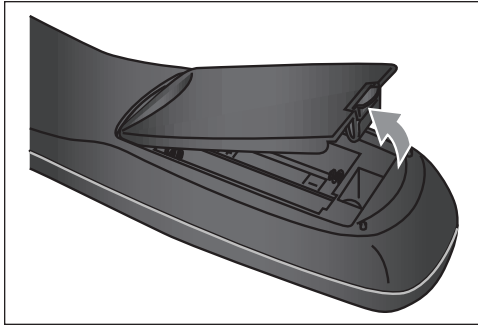
REMOTE CONTROL BATTERY INSTALLATION

Figure A

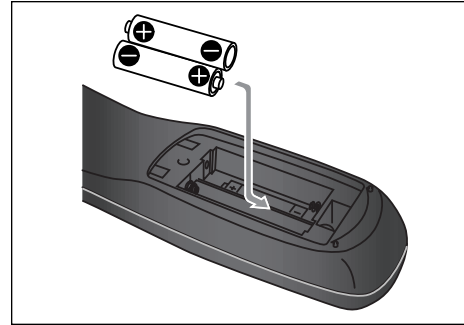


Figure B

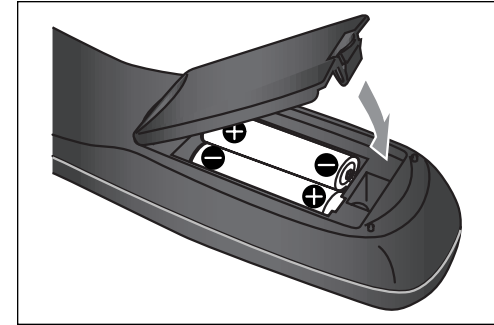


Figure C

The remote control requires two AA batteries that should be replaced as needed. It is strongly recommended to use Alkaline batteries, which last longer without leaking.

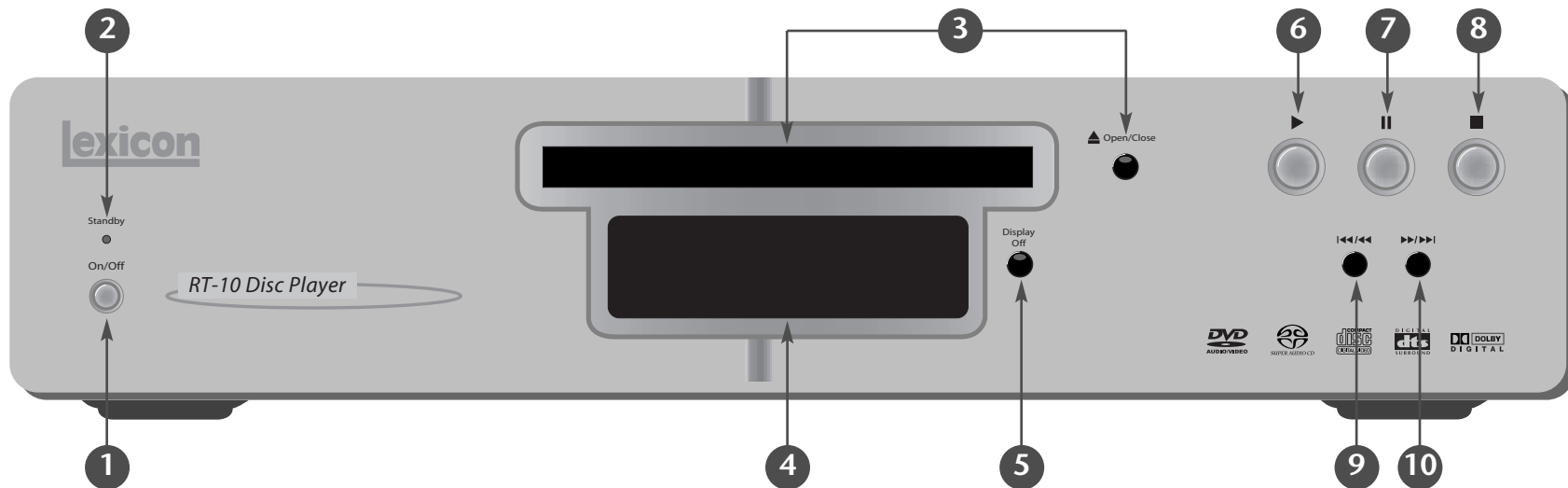
To replace the remote control batteries:

1. Locate the battery compartment on the back of the remote control. Then, remove the battery compartment cover as shown in Figure A (above). To do this, press the tab attached to the cover. When the tab is pressed, pull the cover away from the remote control.
2. Remove and dispose of old batteries inserted in the compartment (if applicable).
3. Insert two AA batteries in the compartment as shown in Figure B (above). Make sure the batteries are correctly inserted observing the proper polarity.
4. When new batteries have been inserted, close the battery compartment cover as shown in the Figure C (above). To do this, align the cover with the guide on the back of the remote control. Then, press the cover until it "snaps" into place.
5. It is recommended to refer to the Remote Control Overview section that begins on page 2-14 before operating the remote control.

2

Basic Operation

Front Panel Overview	2-2
<i>Front Panel Display Indicators</i>	
Rear Panel Overview	2-8
<i>Rear Panel Connections</i>	
Remote Control Overview	2-14
<i>Operation Considerations • Command Matrix</i>	

FRONT PANEL OVERVIEW

The numbers in the RT-10 front panel illustration shown above correspond to the numbered items that begin below.

1. On/Off Button

Connects power from the AC input connector to the RT-10. When the RT-10 is powered on, pressing the On/Off button powers the RT-10 off and automatically deactivates standby mode. When the RT-10 is powered off, pressing the On/Off button powers the RT-10 on. When the RT-10 is powered on, standby mode is deactivated, even if standby mode was activated when the RT-10 was powered off. The On/Off button cannot be used to activate standby mode.

2. Standby LED

Lights to indicate that standby mode is activated. Standby mode can be activated and deactivated with the remote control POWER button or with an associated component connected to the RT-10 trigger input connector. Standby mode is automatically activated after 30 minutes of non-use when the AUTO_P parameter (3-52) is set to ON_30MIN.

When the RT-10 is not configured for trigger control, the remote control POWER button can be used to activate and deactivate standby mode. When the RT-10 is configured for

trigger control, the associated component connected to the RT-10 trigger input connector can be used to activate and deactivate standby mode.

When the RT-10 is powered off, standby mode is automatically deactivated, although the Standby LED remains lit for a few seconds after the RT-10 is powered off. When the RT-10 is powered on, standby mode is also deactivated, even if standby mode was activated when the RT-10 was powered off. The front panel On/Off button cannot be used to activate standby mode.

Note:

Power is still supplied to the RT-10 when standby mode is activated.

3. Disc Drawer & Open/Close Button

Loads and unloads the inserted disc. When the disc drawer is closed, pressing the Open/Close button opens the disc drawer. When the disc drawer is open, pressing the Open/Close button closes the disc drawer. The disc drawer can also be closed with a **gentle** press against the front of the disc drawer.

When the disc drawer is open, pressing the Play button closes the disc drawer and activates playback from the beginning of the loaded disc. Whenever the disc drawer is closed, the RT-10 attempts to load a disc, even if the disc drawer is empty.

Single-sided discs should be loaded with the label side facing upward and double-sided discs should be loaded with the side intended for playback facing downward. All discs must align with the circular guide inside the disc drawer. Refer to the Loading Discs section that begins on page 4-2 for more information.

CAUTION

The RT-10 is a single-disc player. Do not attempt to insert more than one disc into the disc drawer at one time. This might cause damage to the RT-10, the discs, or both.

4. Front Panel Display

Provides at-a-glance viewing of status information about the RT-10 and the loaded disc. Refer to the Front Panel Display section that begins on page 2-6 for more information.

5. Display Off Button

Activates and deactivates the front panel display. When the front panel display is activated, pressing the Display Off button deactivates the front panel display and lights the Display Off button LED. When the front panel display is deactivated, pressing the Display Off button activates the front panel display.

The Display Off button LED:

- Lights to indicate that the front panel display is deactivated
- Does not light when the front panel display is activated
- Blinks to indicate that the Advanced Setup menu is open on the front panel display

... Front Panel Overview continues on page 2-4

Front Panel Overview (continued from page 2-3)

The numbers in the RT-10 front panel illustration shown on page 2-2 correspond to the numbered items that continue below.

5. Display Off Button (continued)

The DISP_MODE parameter (3-52) can be used to select the front panel display mode for SACD, CD, and MP3 playback. When set to ON, the front panel display is deactivated during SACD, CD, and MP3 playback. When playback mode is activated, pressing the Display Off button activates the front panel display for about 3 seconds. When stop mode is activated, the front panel display remains activated until playback resumes.

6. Play Button ▶

Activates playback of the loaded disc at regular playback speed. When pause or resume mode is activated, pressing the Play or Pause button activates playback at the current playback time. When stop mode is activated, pressing the Play button activates playback from the beginning of the loaded disc. When the disc drawer is open, pressing the Play button closes the disc drawer and activates playback from the beginning of the loaded disc.

7. Pause Button II


Activates pause mode, which pauses playback of the loaded disc at the current playback time. When playback is activated, pressing the Pause button activates pause mode at the current playback time. In some cases, a still frame image appears on the associated display device screen. When pause mode is activated, pressing the Pause or Play button activates playback at the current playback time. When resume or stop mode is active, pressing the Pause button performs no function.

8. Stop Button ■







Activates resume mode, which pauses playback of the loaded disc at the current playback time. The Stop button can also be used to activate stop mode, which stops playback of the loaded disc. The table on page 4-12 indicates the playback modes available for each disc format.

When playback or pause mode is activated, pressing the Stop button activates resume or stop mode. In some cases, the Stop button must be pressed twice in succession to activate stop mode. When resume mode is activated, pressing the Stop button activates stop mode.


9. Reverse Skip/Scan Button

Skips and scans in reverse direction through the loaded disc. When resume or stop mode is activated, pressing the  button activates playback from the beginning of the loaded disc.







When playback or pause mode is activated:

- Pressing and releasing the  button skips to the beginning of the current chapter or track. Subsequent presses skip to the beginning of the previous chapter or track. When the RT-10 loads the selection, playback or pause mode reactivates from the beginning of the selected chapter or track.
- Pressing and holding the  button scans through the loaded disc in reverse direction. When the button is released, playback or pause mode reactivates at the current playback time. The front panel  button scans at one speed. The remote control  button scans at three speeds.
- When the beginning of the disc is reached, pressing the  button performs no function. Playback activates from the beginning of the loaded disc, even if the  button is pressed and held.

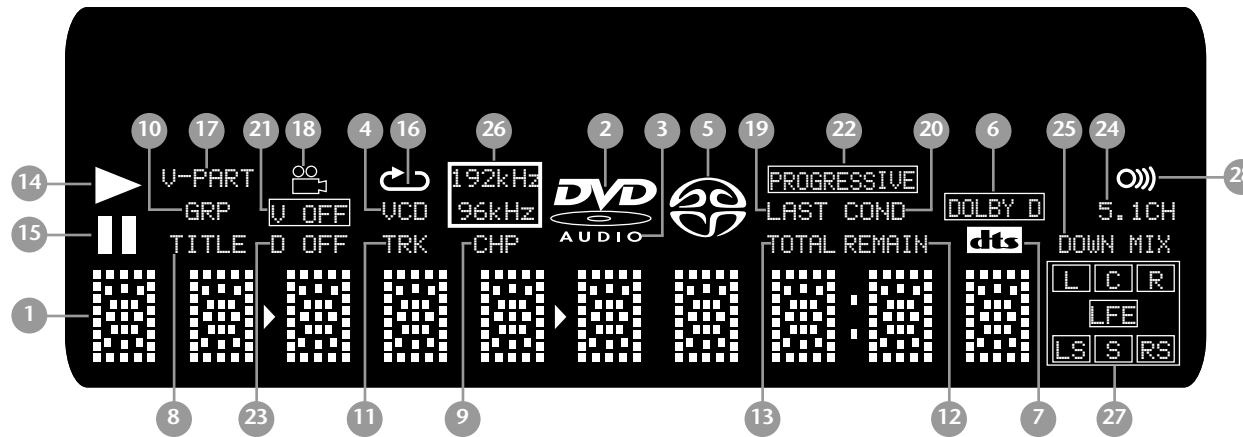
10. Forward Skip/Scan Button

Skips or scans in forward direction through the loaded disc. When resume or stop mode is activated, pressing the  button activates playback from the beginning of the loaded disc.











When playback or pause mode is activated:

- Pressing and releasing the  button skips to the beginning of the next chapter or track. Subsequent presses also skip to the beginning of the next chapter or track. When the RT-10 loads the selection, playback or pause mode reactivates from the beginning of the selected chapter or track.
- Pressing and holding the  button scans through the loaded disc in forward direction. When the button is released, playback or pause mode reactivates at the current playback time. The front panel  button scans at one speed. The remote control  button scans at three speeds.
- When the end of the disc is reached, pressing the  button performs no function. Pause mode activates from the beginning of the loaded disc, even if the  button is pressed and held.

FRONT PANEL DISPLAY INDICATORS



The numbers in the RT-10 front panel display illustration shown above correspond to the numbered items that begin below.

- | | | |
|---|---|--|
| <p>1.  (Character Display)
Provides at-a-glance viewing of status information about the RT-10 and the loaded disc.</p> | <p>4.  VCD
Indicates that a Video CD is loaded.</p> | <p>8.  TITLE
Indicates that the second character on the character display (number 1) is a title number.</p> |
| <p>2.  DVD
Indicates that a DVD-V or DVD-RW/R is loaded.</p> | <p>5.  SACD
Indicates that an SACD is loaded.</p> | <p>9.  CHP
Indicates that the second character on the character display (number 1) is a chapter number.</p> |
| <p>3.  DVD AUDIO
Indicates that a DVD-A is loaded.</p> | <p>6.  DOLBY D
Indicates that a Dolby Digital source is present.</p> | <p>10.  GRP
Indicates that the second character on the character display (number 1) is a group number.</p> |
| | <p>7.  DTS
Indicates that a DTS source is present.</p> | |

11. TRK

Indicates that the second character on the character display (previous page) is a track number.

12. REMAIN

Indicates that the last three characters on the character display (number 1) represent the remaining playback time.

13. TOTAL

Indicates that the last three characters on the character display (previous page) represent the total playback time.

14. ▶

Indicates that playback (4-11) is activated.

15. II

Indicates that pause mode (4-15) is activated.

16. ↺

Indicates that repeat playback (4-19) is activated.

17. V-PART

Indicates that playback of the video portion of the loaded disc is in progress.

18. 🎥

Indicates that playback of a scene recorded from multiple camera angles is in progress. Refer to page 4-9 for information.

19. LAST

Indicates that last memory playback (4-13) is activated.

20. COND

Indicates that preferred disc settings have been stored for the loaded disc. Refer to page 4-10 for more information.

21. 📺 OFF

Indicates that the RT-10 video output connectors are deactivated. The remote control VIDEO ON/OFF button can be used to activate and deactivate all RT-10 video output connectors.

22. PROGRESSIVE

Indicates that the RT-10 component video output connectors are passing progressive-scan (non-interlaced) video signals.

23. D OFF

Indicates that the RT-10 digital audio output connectors are deactivated. The Digital Out parameter (3-14) can be used to activate and deactivate all RT-10 digital audio output connectors.

24. 5.1 CH

Indicates that the Audio Out parameter (3-16) is set to 5.1 Channel.

25. DOWN MIX

Indicates that the Audio Out parameter (3-16) is set to 2 Channel.

26. Sample Rate Indicator

Indicates that a 192kHz or 96kHz source is present. The sample rate – 192kHz or 96kHz – appears in red.

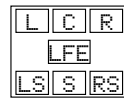
... Front Panel Display Indicators continues on page 2-8

Front Panel Display Indicators (continued from page 2-7)

The numbers in the RT-10 front panel display illustration shown on page 2-6 correspond to the numbered items that continue below.

27. Channels Indicator

Indicates all audio channels available on the loaded disc. The table below provides the channel associated with each letter abbreviation.



Channel	Output Connector
L	Front Left
C	Center
R	Front Right
LFE*	Subwoofer (Low Frequency Effects)
LS	Surround Left
S	Subwoofer
RS	Surround Right

* LFE information is sent to the Sub analog audio output connector.

28. 0000

Indicates that the RT-10 is receiving a remote control IR command, even when the RT-10 is using the IR IN connector. The RT-10 does not receive remote control commands unless the RT-10 is powered on with the front panel On/Off button.

REAR PANEL OVERVIEW

The RT-10 is manufactured for sale in several different countries. Each version features a rear panel that includes connectors and safety instructions appropriate to that particular region.

Note:

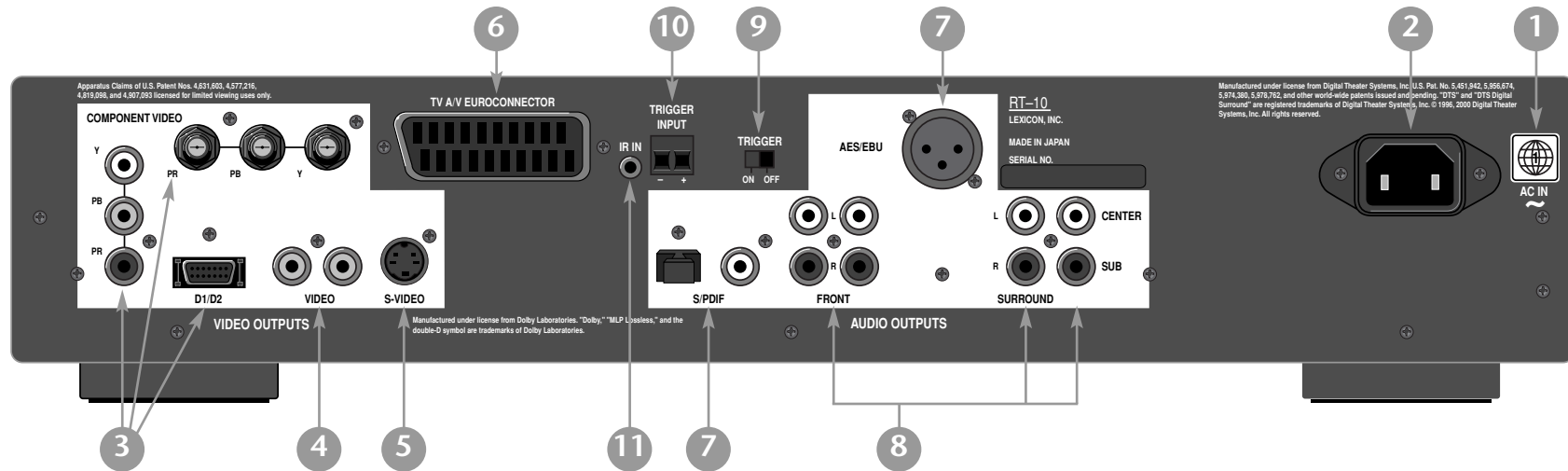
The rear panel shown on the next page includes all possible connectors. However, certain connectors are not included on some versions. These instances are noted in the rear panel connector descriptions that begin below.

1. Region Code Indicator

Indicates the RT-10 region code, which differs from version to version depending on the region of purchase. All DVD-Vs are also marked with a region code, which is often located on the disc packaging. The RT-10 is compatible with discs marked with this same region code or with the ALL region code. The RT-10 is not compatible with discs marked with other region codes.

2. AC Input Connector

Provides power to the RT-10 through the supplied power cord (2 wire, 10 amp, IEC 320). The supplied power cord features the appropriate male-end connector for the region of purchase.



The numbers in the RT-10 rear panel illustration shown above correspond to the numbered items that begin on the previous page.

CAUTION

Damaged power cords can cause fire or electric shock. Please observe the following when handling power cords:

- Handle power cords at the plug.
- Never disconnect power cords by pulling on the cord.
- Never touch power cords with wet hands, as this could cause short circuit or electric shock.
- Protect power cords from being pinched or walked on, particularly at plugs, convenience receptacles, and points of connection with the unit.
- Never tie knots in power cords or tie power cords together.
- Examine power cords for damage on a regular basis.

CAUTION

Never make or break connections to the RT-10 unless the RT-10 and all associated components are powered off.

3. Component Video Output Connectors

Provide component video output. All versions include one group of RCA and one group of BNC connectors labeled COMPONENT VIDEO. Some versions also include a Mini D Ribbon connector labeled D1/D2. All component video output connectors can be used at the same time.

... Rear Panel Overview continues on page 2-10

Rear Panel Overview (continued from page 2-9)

The numbers in the RT-10 rear panel illustration shown on page 2-9 correspond to the numbered items that continue below.

3. Component Video Output Connectors (continued)

The component video output connectors provide progressive-scan and interlaced component video output. Progressive-scan component video output converts interlaced video signals to progressive video signals, doubling the amount of video information sent to a compatible display device. The result is a higher quality, more stable image with fewer video artifacts.

4. Composite Video Output Connectors

Provide composite video output. All versions include two RCA connectors labeled VIDEO. All composite video output connectors can be used at the same time.

5. S-video Output Connector

Provide S-video output. All versions include one S-video connector labeled S-VIDEO.

6. Euro or Peritel (TV A/V) Connector

Provides composite, S-video, or RGB video and two channels of audio output. Some versions include one SCART connector labeled TV A/V CONNECTOR. The Video Out parameter (3-27) controls video output format when the RT-10 is using the Euro or Peritel (TV A/V) connector.

7. Digital Audio Output Connectors

Provide digital audio output. All versions include one coaxial and one optical connector labeled S/PDIF, as well as one XLR connector labeled AES/EBU. The connector labeled AES/EBU provides S/PDIF digital audio output with AES/EBU electrical characteristics.

8. Analog Audio Output Connectors

Provide analog audio output. All models include eight RCA connectors labeled Front L/R (2 pairs), Surround L/R, Center, and Sub. The Audio Out parameter (3-16) can be used to configure these connectors to provide 2- or 5.1-channel analog audio output.

9. Trigger Input Switch

Enables and disables trigger control when the trigger input connector (number 10) on the RT-10 is connected to the trigger output connector on an associated component.

When the trigger input connector on the RT-10 is connected to the trigger output connector on an associated component and the trigger input switch is set to ON, the RT-10 responds when standby mode is activated or deactivated for the connected component. **Whenever the trigger input switch is set to ON, the remote control POWER button cannot be used to activate and deactivate standby mode, even when the RT-10 is not using the trigger input connector.**

Note:

The trigger input switch setting does not take effect until the RT-10 is power cycled with the front panel On/Off button.

10. Trigger Input Connector

Allows the RT-10 to be controlled with an associated component that includes a 12V DC trigger output connector, such as the MC-12 or MC-8 Digital Controllers. All versions include one trigger input connector labeled TRIGGER INPUT, which is available on a removable terminal block.

To configure the RT-10 for trigger control:

1. Connect the trigger input connector on the RT-10 to a 12V DC trigger output connector on an associated component.
2. Set the RT-10 trigger input switch (previous page) to ON.
3. Power cycle the RT-10 with the front panel On/Off button (2-2).

The RT-10 will respond when standby mode is activated or deactivated for the connected component. The RT-10 will not respond to the remote control POWER button.

11. IR IN Connector

Provides input of infrared data from industry-standard infrared distribution equipment. All models include one female 3.5mm Tip/Ring/Sleeve connector labeled IR IN.

REAR PANEL CONNECTIONS

The RT-10 is manufactured for sale in several different countries. Each version features a rear panel that includes connectors and safety instructions appropriate to that particular region.

Note:

The rear panel shown on page 2-9 includes all possible connectors. However, certain connectors are not included on some versions. These instances are noted in the rear panel connector descriptions that begin on page 2-8.

All versions require at least one video and one audio connection. These are the minimum connections required for playback. However, it is recommended to configure a digital and an analog audio connection for optimal performance. An analog audio output connection is required for SACD playback and recommended for DVD-A playback. All connections require standard video and audio cables.

Video Connections

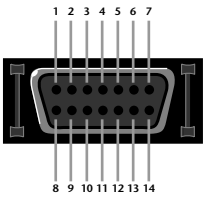
Note:

All video output connectors are active at all times unless deactivated with the remote control VIDEO ON/OFF button (2-15).

. . . Video Connections continues on page 2-12

Video Connections (continued from page 2-11)

Mini D Ribbon Component Video Output Connector



Pin	Description
1	Y or Green
2	Green Ground
3	BY, B-Y, or Blue
4	Blue Ground
5	RY, R-Y, or Red
6	Red Ground

All other pins are N/C (no connection).

Whenever possible, it is recommended to use a component video output connection. All versions offer component video output on a group of RCA or BNC connectors. Some versions also offer component video output on a Mini D Ribbon connector. Refer to the table and illustration above for more information about the Mini D Ribbon connector.

Progressive-scan component video output is available on all component video output connectors. Compared to interlaced video signals, progressive-scan video signals double the amount of video information sent to a compatible display device. For highest picture quality, it is recommended to use a progressive-scan compatible display device.

Note:

Progressive-scan component video output is only available for NTSC discs

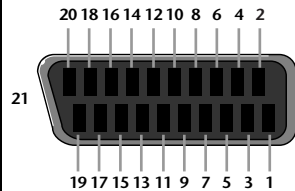
When a component video output connection is not possible, it is recommended to use an S-video output connection, which provides better picture quality than a composite video output connection. All versions offer S-video output on an S-video output connector.

S-video cables can be difficult to connect. Because these cable plugs are keyed, it is important to insert them with the proper orientation to the connector. Make sure the cable plug is properly aligned with the connector before the cable plug is inserted. In addition, make sure the cable plug is fully inserted for a solid connection.

When neither a component nor S-video output connection is possible, use a composite video output connection. All versions offer composite video output on an RCA connector. Some versions also offer composite video output on a Euro or Peritel (TV A/V) connector (below).

Euro or Peritel (TV A/V) Connections

Some versions include a Euro or Peritel (TV A/V) connector that offers composite, S-video, or RGB video and two channels of audio output on a SCART connector labeled TV A/V CONNECTOR. When making this connection, use a 21-pin male-to-male SCART cable with a SCART plug on both ends. The Video Out parameter (3-27) controls video output format when the RT-10 is using the Euro or Peritel (TV A/V) connector. Refer to the table and illustration at the top of the next page for more information.

Euro or Peritel (TV A/V) Connector

Pin	Description	Pin	Description
1	Audio Out Right	12	NC
2	NC	13	RGB Red Ground
3	Audio Out Left + Mono	14	Ground
4	Audio Ground	15	RGB Red Out/Chrominance
5	RGB Blue Ground	16	RGB Switch
6	NC	17	Composite Video Ground
7	RGB Blue Out	18	Ground
8	Audio/RGB Switch/16:9	19	Composite Video Out/Luminance
9	RGB Green Ground	20	NC
10	NC	21	Ground/Shield (Chassis)
11	RGB Green Out		

Digital Audio Connections

All versions offer digital audio output on S/PDIF coaxial, S/PDIF optical, and XLR (AES/EBU) connectors. The AES/EBU connector offers S/PDIF digital audio output with AES/EBU electrical characteristics.

When making S/PDIF coaxial connections, use a video interconnect cable with RCA plugs on each end. Make sure the cable plug is fully inserted for a solid connection. When making S/PDIF optical

connections, use an interconnect cable with Toslink® plugs on each end. Because these cable plugs are keyed, it is important to insert them with the proper orientation to the connector. Make sure the cable plug is properly aligned with the connector before the cable plug is inserted. When the cable plug is inserted, the protective shutter on the connector will open and the plug will click into position, indicating that the cable plug is fully inserted.

Analog Audio Connections

All versions offer analog audio output on eight RCA connectors labeled Front L/R (2 pairs), Surround L/R, Center, and Sub. When making these connections, use standard audio cables with RCA plugs on each end. The Audio Out parameter (3-16) can be used to configure these connectors to provide 2- or 5.1-channel analog audio output.

The analog audio output connectors are color-coded to match the cable plugs. Make sure the cable plugs are fully inserted for a solid connection.

DVD-A & SACD Connections

An analog audio output connection is required for SACD and recommended for DVD-A playback. When DVD-A sources are sent to the digital audio output connectors, multi-channel signals are downmixed and high sample rates of 176.4 or 192kHz are downsampled to 44.1, 48, 88.2, or 96kHz. The downsampled rate differs from disc to disc.

REMOTE CONTROL OVERVIEW

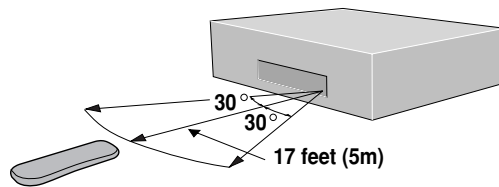
The RT-10 remote control provides full operation of the RT-10, executing functions such as menu navigation that are not available from the front panel. The numbers in the RT-10 remote control illustrations shown on pages 2-15 to 2-18 correspond to the numbered items in the Command Matrix that begins on page 2-15. The Command Matrix describes the commands remote control buttons execute.

OPERATION CONSIDERATIONS

The bulleted items that begin below describe factors that can improve or impede remote control operation. It is recommended to observe these items as well as the battery installation instructions on page 1-9 before operating the remote control.

Note the following:

- If the RT-10 is not using the IR IN connector, the remote control must be in line-of-sight with the front panel display remote control sensor. Eliminate obstructions between the remote control and the remote control sensor. The remote control might become unreliable if strong sunlight or fluorescent light is shining on the remote control sensor.
- For optimal performance, position the remote control at a 30 degree angle no more than 17 feet (5m) from the RT-10 as shown below. If the RT-10 is placed inside a glass cabinet, smoked glass will reduce the remote control range.






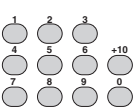


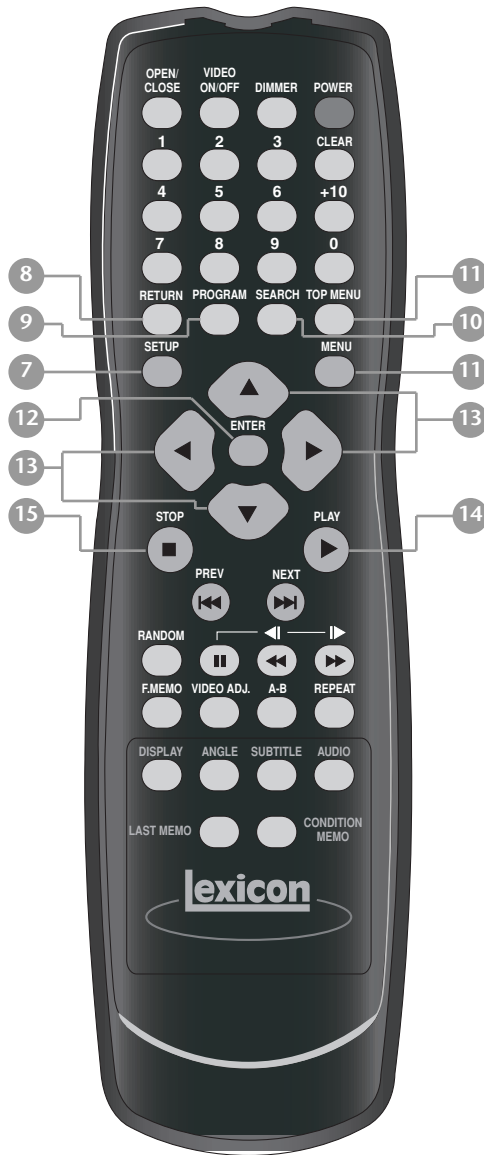
- Remote controllers for different components can interfere with one another. It is recommended to avoid using remote controls for different components at the same time.
- The remote control requires two AA batteries that should be replaced as needed. It is strongly recommended to use Alkaline batteries, which last longer without leaking. Refer to page 1-9 for more information.

COMMAND MATRIX

The matrix that begins on the next page describes the commands remote control buttons execute. The numbers in the RT-10 remote control illustration shown on the next page correspond to the numbered items in the Command Matrix.























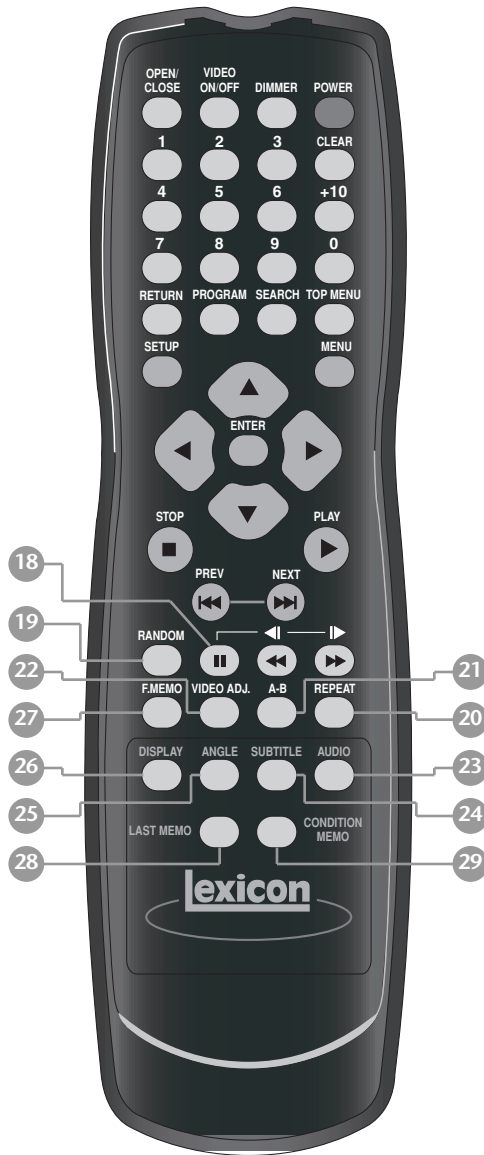
Button	Command
<p>1 POWER</p> 	<p>Activates and deactivates standby mode when all of the following conditions are met:</p> <ul style="list-style-type: none"> The RT-10 is not configured for trigger control. The RT-10 is powered on with the front panel On/Off button. The trigger input switch is set to OFF. <p>When standby mode is deactivated, pressing the POWER button activates standby mode and lights the front panel Standby LED (2-2). When standby mode is activated, pressing the POWER button deactivates standby mode. The Standby LED is not lit when standby mode is deactivated.</p> <p>Note the following:</p> <ul style="list-style-type: none"> Power is still supplied to the RT-10 when standby mode is activated.
<p>2 DIMMER</p> 	<p>Controls the brightness of front panel display characters. Pressing this button cycles through 100%, 75%, and off settings. When off is selected, the front panel Display Off button LED lights.</p>
<p>3 VIDEO ON/OFF</p> 	<p>Activates and deactivates the rear panel video output connectors, including component, composite, S-video, and Euro or Peritel (TV A/V) connectors (2-9 and 2-10). When these connectors are deactivated, pressing the VIDEO ON/OFF button activates these connectors, allowing video signals to pass to the associated component. When these connectors are activated, pressing the VIDEO ON/OFF button deactivates these connectors, preventing video signals from passing to the associated component. The V OFF indicator (2-7) appears on the front panel display to indicate that the video output connectors are deactivated.</p>
<p>4 OPEN/CLOSE</p> 	<p>Opens and closes the disc drawer (2-3). When the disc drawer is closed, pressing the Open/Close button opens the disc drawer. When the disc drawer is open, pressing the Open/Close button closes the disc drawer. The disc drawer can also be closed with a gentle press against the front of the disc drawer.</p>
<p>5 CLEAR</p> 	<p>Deletes entries when search modes and certain playback modes are activated. Refer to Section 4 for more information.</p>
<p>6</p> 	<p>When a disc is loaded and the disc menu is closed, pressing a number button activates playback at the selected title, chapter, group, or track number. When a disc is loaded and the disc menu is open, pressing a number button selects the corresponding menu item (4-5 and 4-6). In some cases, the number buttons can also be used to enter playback mode values (Section 4).</p> <p>To enter values 10 and above, press the +10 button once for numbers in the teens, twice for numbers in the twenties, and so on. Then, press a number button (0 to 9) to enter the second digit. For instance, entering a value of 25 requires a button sequence of +10, +10, and 5.</p>















Button	Command
7 SETUP	Opens and closes the Setup (3-9) and Advanced Setup (3-51) menus.
8 RETURN	Closes certain Setup menu screens without saving changes. Refer to Section 3 for more information.
9 PROGRAM	Activates program mode (4-22), which creates a program list for the loaded disc. When a program list has been created, program mode also activates program playback.
10 SEARCH	Activates search mode (4-28), which activates playback of a specific title, chapter, group, track, folder, time, frame, or page on the loaded disc.
11 TOP MENU MENU	Open the disc menu or top menu, provided the loaded disc includes a menu. In some cases, pressing the MENU and TOP MENU buttons opens the same menu. In some cases, a specific button must be pressed to open the menu. For instance, the TOP MENU button must be pressed to open DVD-A top menus. Refer to the Disc Menu Command Matrix on pages 4-5 and 4-6 for more information.
12 ENTER	When the Setup or Advanced Setup menu is open, pressing the ENTER button selects the highlighted parameter or setting. When certain playback modes are activated, pressing the ENTER button executes the selected option. Refer to Sections 3 and 4 for more information.
13	Navigate through the Setup and Advanced Setup menus, as well as certain disc menus. Instances in which the ◀ and ▶ arrows perform different functions are noted throughout this user guide. Refer to Sections 3 and 4 for more information.
14 PLAY	Activates playback of the loaded disc at regular playback speed. When pause or resume mode is activated, pressing the Play or Pause button activates playback at the current playback time. When stop mode is activated, pressing the Play button activates playback from the beginning of the loaded disc. When the disc drawer is open, pressing the Play button closes the disc drawer and activates playback from the beginning of the loaded disc.
15 STOP	Activates resume mode, which pauses playback of the loaded disc at the current playback time. The Stop button can also be used to activate stop mode, which stops playback of the loaded disc. The table on page 4-12 indicates the playback modes available for each disc format. When playback or pause mode is activated, pressing the Stop button activates resume or stop mode. In some cases, the Stop button must be pressed twice in succession to activate stop mode. When resume mode is activated, pressing the Stop button activates stop mode.



Button	Command
<p>16</p> <p>PREV</p> 	<p>Skips to the beginning of the current chapter or track. Subsequent presses skip to the beginning of the previous chapter or track. When the RT-10 loads the selection, playback or pause mode reactivates from the beginning of the selected chapter or track.</p>
<p>NEXT</p> 	<p>Skips to the beginning of the next chapter or track. Subsequent presses also skip to the beginning of the next chapter or track. When the RT-10 loads the selection, playback or pause mode reactivates from the beginning of the selected chapter or track.</p>
<p>17</p> 	<ul style="list-style-type: none"> • When playback is activated, pressing the  button scans through the loaded disc in reverse direction. Subsequent presses cycle through available scanning speeds. The  button scans at three speeds. The front panel  button scans at one speed. Pressing the Play button reactivates playback at the current playback time. • When pause mode is activated, pressing and releasing the  button activates frame-by-frame playback in reverse direction. When the button is released, pause mode reactivates at the current playback time. • When pause mode is activated, pressing and holding the  button for 1 second activates slow playback in reverse direction at 1/16 regular playback speed. When slow playback is activated, pressing and releasing the  button cycles through 1/16, 1/8, 1/4, and 1/2 regular playback speeds. Pressing the Play button reactivates playback at the current playback time. • When the beginning of the disc is reached, pressing the  button performs no function. Playback activates from the beginning of the loaded disc, even if the  button is pressed and held.
	<ul style="list-style-type: none"> • When playback (4-12) is activated, pressing the  button scans through the loaded disc in forward direction. Subsequent presses cycle through available scanning speeds. The  button scans at three speeds. The front panel  button scans at one speed. Pressing the Play button reactivates playback at the current playback time. • When pause mode is activated, pressing and releasing the  button activates frame-by-frame playback in forward direction. When the button is released, pause mode reactivates at the current playback time. • When pause mode is activated, pressing and holding the  button for 1 second activates slow playback in forward direction at 1/16 regular playback speed. When slow playback is activated, pressing and releasing the  button cycles through 1/16, 1/8, 1/4, and 1/2 regular playback speeds. Pressing the Play button reactivates playback at the current playback time. • When the end of the disc is reached, pressing the  button performs no function. Pause mode activates from the beginning of the loaded disc, even if the  button is pressed and held.



Button	Command
18 	Activates pause mode, which pauses playback of the loaded disc at the current playback time. When playback is activated, pressing the Pause button activates pause mode at the current playback time. In some cases, a still frame image appears on the associated display device screen. When pause mode is activated, pressing the Pause or Play button activates playback at the current playback time. When resume or stop mode is active, pressing the Pause button performs no function.
19 	Activates random playback (4-17), which plays the loaded disc in a random order of titles, chapters, groups, or tracks.
20 	Activates repeat playback (4-19), which repeats playback of the loaded disc or the currently playing title, chapter, group, track, folder, or program list.
21 	Activates A-B repeat playback (4-21), which repeats playback from a user-defined start time (point A) to a user-defined end time (point B).
22 	Opens and closes the Video Adjust bar, which can be used to make exact, detailed adjustments of video settings. Refer to the Video Adjust section that begins on page 3-29 for more information.
23 	Opens the Audio bar, which can be used to select the desired audio track (audio language and output format) on the loaded disc (4-7).
24 	Opens the Subtitle bar, which can be used to select the desired subtitle language (4-8).
25 	Opens the Angle bar, which can be used to select the desired camera angle (4-9).
26 	Activates display mode (4-30), which opens an on-screen display screen or bar that provides information about the loaded disc
27 	Creates up to five shortcuts for frequently adjusted Setup menu parameters (3-50).
28 	Activates last memory playback (4-13), which creates a bookmark at the current playback time. Later, playback can be reactivated from the bookmarked playback time.
29 	Activates condition memory mode (4-10), which stores preferred disc settings for up to 15 DVD-Vs. Once stored, these settings will be automatically recalled whenever the disc is loaded.

3

Setup Menus

Control Bar	3-2
Setup Navigator	3-2
Setup Menu	3-9
<i>Audio1 • Audio2 • Video1 • Video2 • Language • General</i>	
Setup Menu Shortcuts	3-50
Advanced Setup Menu	3-51

Note:

The Setup menu should be used to configure the RT-10 before attempting disc playback.

CONTROL BAR

When a Setup menu screen is open, a control bar similar to the one shown below appears at the bottom of the on-screen display to indicate which remote control buttons are available for the open screen. These buttons appear on the control bar with a one-word description of their associated commands.

For instance, the control bar shown below indicates that the SETUP button, ENTER button, and ◀ and ▼ arrows are available for the open screen. The SETUP button can be used to "Exit" or close the open screen. The ENTER button can be used to "Select" the highlighted setting. And, the ◀ and ▼ arrows can be used to "Move" or navigate around the screen.

No matter which menu screen is open, the ◀, ▶, ▲, and ▼ arrows will appear on the control bar. However, only the lighter-colored arrows can be used to navigate around the screen.

**SETUP NAVIGATOR**

The Setup Navigator is a convenient tool that can be used to configure basic RT-10 settings without navigating through the entire Setup menu. It presents a series of prompts that provide step-by-step guidance through the process of selecting minimum audio, video, and language settings.

With the exception of the last Setup Navigator prompt, all prompts represent a simplified version of actual Setup menu parameters. For instance, the TV Type prompt (3-5) is associated with the Video1 tab TV Screen parameter (3-25). **The table on the next page lists all Setup Navigator prompts, along with their possible settings and associated Setup menu parameters.**

When the RT-10 is first powered on, the Setup Navigator opens on the on-screen display whenever the remote control SETUP button is pressed while the RT-10 is in stop mode. Otherwise, the Setup Navigator can be opened from the Setup menu General tab (3-42). Refer to the Setup Navigator prompt description on page 3-4 for more information.

To open the Setup Navigator:


1. Press the Stop button to activate stop mode. In some cases, the Stop button must be pressed twice in succession to activate stop mode.
2. When stop mode is activated, press the remote control SETUP button to open the Setup Navigator. If the Setup Navigator does not open, it must be opened from the Setup menu General tab (3-42).

Setup Navigator Prompts







The table shown at the right lists all Setup Navigator prompts, along with their possible settings and associated Setup menu parameters.

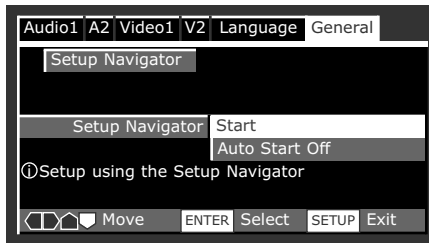
Note:

Setup Navigator prompts should be configured while the disc drawer is empty.

 This setting is recommended when the RT-10 is connected to an MC-12 or MC-8 Digital Controller. When no setting is indicated, any setting can be selected.

... Setup Navigator continues on page 3-4

Setup Navigator Prompt	Available Settings		Associated Setup Menu Parameter(s)
Setup Navigator	• Start	• Auto Start Off	Setup Navigator (General tab, 3-42)
OSD Language	• English • français • Deutsch	• Italiano • Español	OSD Language (Language tab, 3-36)
TV Type	• Widescreen (16:9)	• Standard (4:3)	TV Screen (Video1 tab, 3-25)
Analog Jacks	• 2 Channel • 5.1 Channel 	• Not Connected	Audio Out (Audio2 tab, 3-16)
Center Speaker	• Present 	• Not Present	Speaker Setting (Audio2 tab, 3-18)
Surround Speakers	• Present 	• Not Present	Speaker Setting (Audio2 tab, 3-18)
Sub-woofer	• Present 	• Not Present	Speaker Setting (Audio2 tab, 3-18)
Digital Jack	• Dolby Digital • Dolby Digital/DTS  • Dolby Digital/MPEG	• Dolby D/DTS/MPEG • PCM • Not Connected	Dolby Digital Out (3-12) DTS Out (3-13) MPEG Out (3-14) (Audio1 tab)
96kHz PCM Audio	• No • Yes 	• Don't Know	Linear PCM Out (Audio1 tab, 3-13)
Exit Setup Navigator	• Save Changes • Delete Changes	• Start Again	None

Setup Navigator (continued from page 3-3)**To navigate the Setup Navigator:**

Button	Command
ENTER	Selects the highlighted setting. When a setting is selected, the Setup Navigator automatically proceeds to the next prompt.
◀	Returns to the previous Setup Navigator prompt. When the first Setup Navigator prompt is open, pressing the ▶ arrow performs no function.
▲ and ▼	Scroll upward and downward through parameter settings.
RETURN	Closes the Setup Navigator without saving the selected settings.
SETUP	Closes the Setup Navigator and the Setup menu without saving the selected settings.

Setup Navigator

Start, Auto Start Off

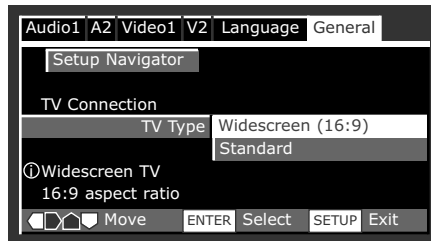
Activates and deactivates the Setup Navigator. Select Start to activate the Setup Navigator and proceed to the OSD Language prompt (below). Select Auto Start Off to deactivate the Setup Navigator. Once deactivated, the Setup Navigator must be opened from the Setup menu General tab (3-42).

The Setup Navigator prompt is associated with the General tab Setup Navigator parameter (3-42). When the Setup Navigator is opened from the General tab, the Auto Start Off option is not available.

OSD Language

English, français, Deutsch, Italiano, Español

Determines the language in which RT-10 on-screen display menus appear. The OSD Language prompt is associated with the Language tab OSD Language parameter (3-36).



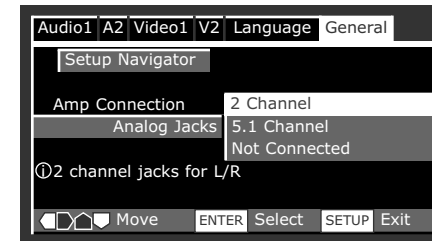
TV Type

Widescreen (16:9), Standard (4:3)

Controls the appearance of the picture on the associated display device screen, formatting the aspect ratio of the video output format to match the aspect ratio of the display device. Aspect ratios, which refer to width relative to height, differ among video output formats and display devices. A 16:9 aspect ratio is almost twice as wide as high and a 4:3 aspect ratio is almost square.

Select Widescreen (16:9) if the associated display device screen has a 16:9 aspect ratio. Select Standard (4:3) if the associated display device screen has a 4:3 aspect ratio. The appearance of the picture depends on the TV Type prompt setting, the video output format, the loaded disc, and display device settings.

The TV Type prompt is associated with the Video1 tab TV Screen parameter (3-25). The TV Type prompt Widescreen (16:9) setting is equivalent to the TV Screen parameter 16:9 (Wide) setting, and the TV Type prompt Standard (4:3) setting is equivalent to the TV Screen parameter 4:3 (Letter Box) setting. The TV Screen parameter also offers settings for 16:9 (Compressed) and 4:3 (Pan&Scan) viewing. Refer to the table on pages 3-25 and 3-26 for more information.



Note:

- Some discs do not allow video output format adjustments.
- Neither the TV Type prompt nor the TV Screen parameter can be adjusted when the RT-10 is in playback mode.

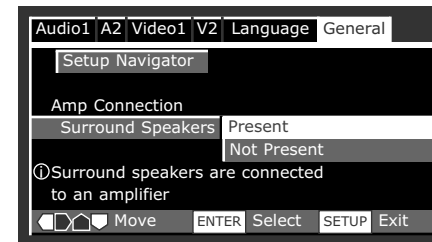
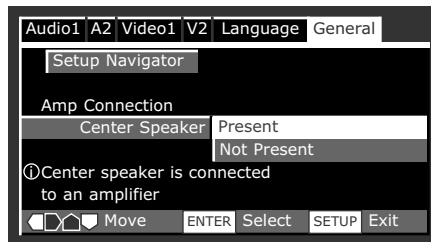
Analog Jacks

2 Channel, 5.1 Channel, Not Connected

Controls analog audio output format when the RT-10 is using the analog audio output connectors. Select Not Connected if the RT-10 is not using the analog audio output connectors.

When 2 Channel is selected, the RT-10 passes analog audio sources to the Front L/R analog audio output connectors. When 5.1 Channel is selected, the RT-10 passes analog audio sources to the Front L/R, Surround L/R, Center, and Sub analog audio output connectors. Refer to the table on page 3-17 for more information.

... Setup Navigator continues on page 3-6

Setup Navigator (continued from page 3-5)**Analog Jacks** (continued)

The Analog Jacks prompt is associated with the Audio2 tab Audio Out parameter (3-16). The Analog Jacks prompt and Audio Out parameter settings have no effect when the RT-10 is not using the analog audio output connectors.

Note the following:

- The Analog Jacks prompt and Audio Out parameter can be used to select the desired audio output format as long as a compatible audio track is selected on the loaded disc. Refer to page 4-7 for information about audio track selection.
- When the Analog Jacks prompt is set to 2 Channel, the Setup Navigator proceeds to the Digital Jack prompt (next page). When set to 5.1 Channel, the Setup Navigator proceeds to the Center Speaker prompt (next column).

Center Speaker

Present, Not Present

Indicates the presence or absence of a center speaker. When Present is selected, the RT-10 passes center channel signals to the Center analog audio output connector. When Not Present is selected, the RT-10 redirects center channel signals to the Front L/R analog audio output connectors.

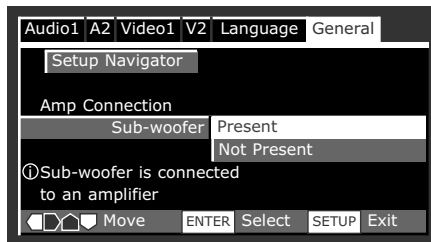
The Center Speaker prompt is associated with the Audio2 tab Speaker Setting option, which can be used to set speaker sizes and distances.

Surround Speakers

Present, Not Present

Indicates the presence or absence of surround speakers. When Present is selected, the RT-10 passes surround channel signals to the Surround L/R analog audio output connectors. When Not Present is selected, the RT-10 redirects surround channel signals to the Front L/R analog audio output connectors.

The Surround Speakers prompt is associated with the Audio2 tab Speaker Setting option, which can be used to set speaker sizes and distances.



Sub-woofer

Present, Not Present

Indicates the presence or absence of a subwoofer. When Present is selected, the RT-10 passes subwoofer signals (LFE) to the Sub analog audio output connector. When Not Present is selected, the RT-10 does not redirect low-frequency signals to other analog audio output connectors.

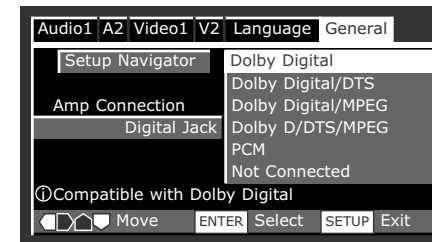
The Sub-woofer prompt is associated with the Audio2 tab Speaker Setting option, which can be used to set speaker sizes and distances.

Digital Jack

Refer to the table on page 3-3

Controls digital audio output format when the RT-10 is using the digital audio output connector. Select Not Connected if the RT-10 is not using the digital audio output connector.

Select the setting that includes all digital audio sources with which the associated component is compatible. The RT-10 will convert all other digital audio signals to PCM signals before passing them to the associated component. With the exception of the Not



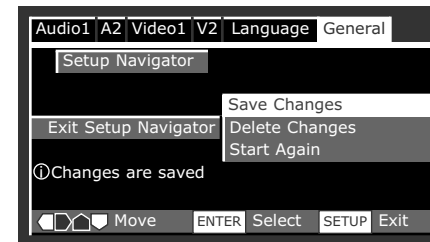
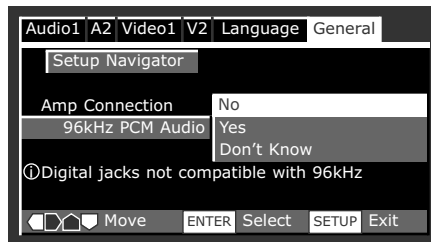
Connected setting, all Digital Jack prompt settings assume the associated component is compatible with PCM signals.

For example, the MC-12 and MC-8 Digital Controllers are compatible with Dolby Digital, DTS, and PCM digital audio sources. If the RT-10 is connected to one of these components, select the Dolby Digital/DTS setting. The RT-10 will pass Dolby Digital, DTS, and PCM signals directly to the MC-12 or MC-8. The RT-10 will convert all other digital audio signals (i.e. MPEG) to PCM before passing them to the MC-12 or MC-8.

Associated components that are NOT compatible with DTS sources will output DTS noise when all of the following conditions are met:

- A DTS source is present.
- The Digital Jack prompt is set to Dolby Digital/DTS or Dolby D/DTS/MPEG OR the DTS Out parameter is set to DTS.

... Setup Navigator continues on page 3-8

Setup Navigator (continued from page 3-5)**Digital Jack** (continued)

The Digital Jack prompt is associated with the Audio1 tab Dolby Digital Out (3-12), DTS Out (3-13), and MPEG Out (3-14) parameters. Each parameter can be independently set for compatibility with the respective digital audio source. The Digital Jack prompt Dolby Digital Out, DTS Out, and MPEG Out parameter settings have no effect when the RT-10 is not using the digital audio output connector.

Note:

When the Digital Jack prompt is set to Not Connected, the Setup Navigator proceeds to the Exit Setup Navigator prompt (3-4). When set to another setting, the Setup Navigator proceeds to the 96kHz PCM Audio prompt (below).

96kHz PCM Audio

No, Yes, Don't Know

Controls PCM digital audio output sample rate when the RT-10 is using the digital audio output connector. This prompt is not available when the Digital Jack prompt is set to Not Connected.

Select No if the associated component is not compatible with 96kHz PCM sources. The RT-10 will downsample 96kHz PCM signals to 48kHz before passing them to the associated component. Select Yes if the associated component is compatible with 96kHz PCM sources. The RT-10 will not downsample 96kHz PCM signals before passing them to the associated component. **Selecting the 96kHz PCM Audio Don't Know setting has the same effect as selecting the No setting.**

The 96kHz PCM Audio prompt is associated with the Audio1 tab Linear PCM Out parameter, which can be set for compatibility with PCM digital audio sources.

Note:

The RT-10 always downsamples 192 and 176kHz signals to 96 and 88.2kHz before passing them to the associated component, regardless of the 96kHz PCM Audio prompt and Linear PCM Out parameter settings.

Exit Setup Navigator Save or Delete Changes, Start Again
Determines whether Setup Navigator prompt settings are saved, deleted, or reentered. Select Save Changes to save prompt settings and close the Setup Navigator. Select Delete Changes to delete prompt settings and close the Setup Navigator. Select Start Again to reenter prompt settings. The OSD Language prompt (3-4) will open on the on-screen display. The Exit Setup Navigator prompt is not associated with a Setup menu parameter.

SETUP MENU

The Setup menu can be used to configure audio, video, language, and other general RT-10 settings. Available in expert and basic display modes, the Setup menu can be configured for the desired level of control. The Setup Menu Mode parameter (3-42) can be used to select the mode in which the Setup menu is displayed.

Setup Menu Mode Expert, Basic

Determines the mode in which the Setup menu is displayed. Select Expert to display the Setup menu in expert mode, which includes all available parameters. The Setup menu is shown in expert mode at the top of the next page. Select Basic to display the Setup menu in basic mode, which only includes parameters that are required to configure the most common RT-10 settings. When displayed in basic mode, the Setup menu also includes a tutorial to describe the highlighted menu item. The Setup menu is shown in basic mode at the bottom of the next page.

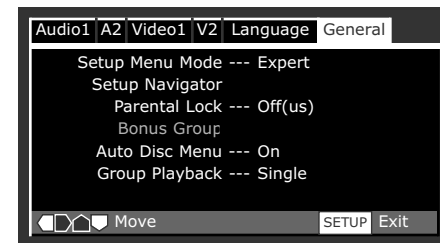
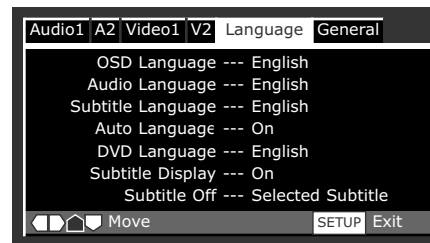
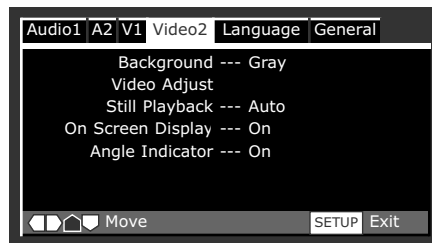
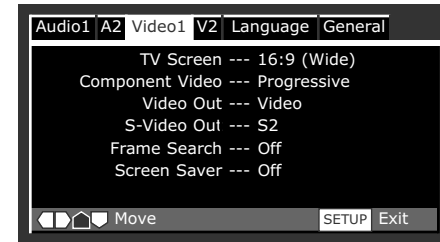
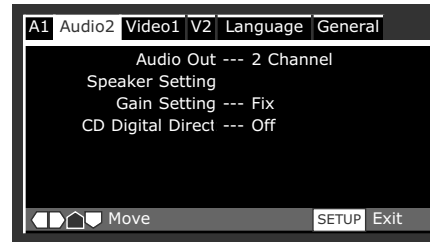
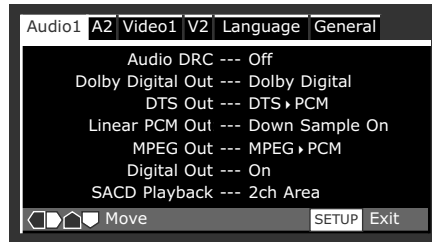
To open the Setup Menu:

Press the remote control SETUP button.

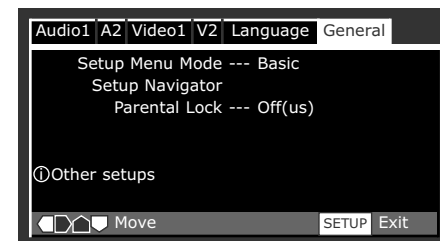
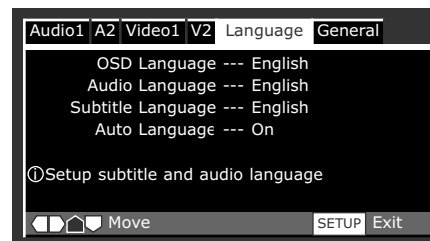
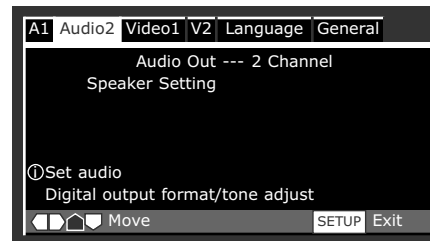
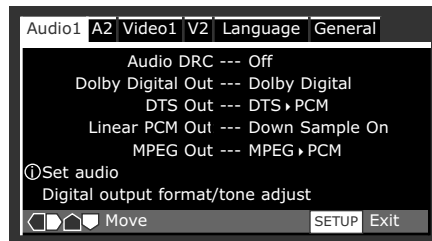
To navigate the Setup menu:

Button	Command
ENTER	Selects the highlighted parameter or setting.
◀ and ▶	Scroll left and right through Setup menu tabs. When a parameter is highlighted, pressing the ▶ arrow selects that parameter.
▲ and ▼	Scroll upward and downward through Setup menu tabs, parameters, and settings.
RETURN	When a Setup menu tab is highlighted, pressing the RETURN button closes the Setup menu without saving parameter settings that have been selected since the Setup menu was opened. When a parameter or setting is selected, pressing the RETURN button closes the selected parameter without saving changes. When this occurs, the cursor moves to the selected Setup menu tab.
SETUP	Closes the Setup menu. (The Setup menu automatically closes a few seconds after the last command is received.)

**Setup Menu
(Expert Mode)**



**Setup Menu
(Basic Mode)**



Note the following:

- The RT-10 is manufactured for sale in several different countries. Certain parameters are not available on some versions. Default parameter settings might differ among versions.
- The Setup menu can be opened while the RT-10 is in playback, pause, resume, or stop mode. However, certain parameters cannot be adjusted when some playback modes are activated. In addition, certain parameters can be adjusted when playback is activated, although the setting does not take effect until stop mode is activated.
- The Setup menu can be opened regardless of the format of the loaded disc. However, certain parameters cannot be adjusted when some disc formats are loaded.
- Certain parameter settings have no effect on some disc formats. When a parameter is selected, colored boxes appear next to each parameter setting on the on-screen display to indicate the disc formats on which each setting has an effect. The table shown below indicates the disc formats each color represents.

Color	Disc Formats
Green	All disc formats
Blue	DVD-V, DVD-A, DVD-RW/R
Yellow	DVD-V and Video CD
Orange	DVD-A, Audio CD, SACD

This table lists colors that might differ depending on RT-10 settings and display device capabilities.

- The icon shown at the right appears on the on-screen display when a Setup menu parameter that is exclusive to DVD formats is adjusted while another disc format is loaded. These adjustments will take effect the next time a DVD is loaded.



AUDIO1

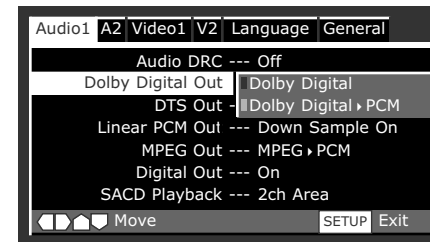
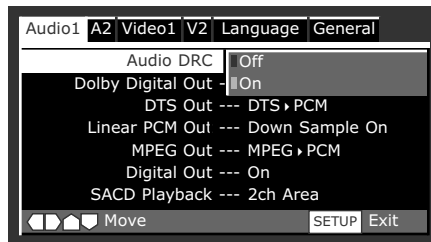
Includes parameters that control digital audio output format.

Parameter	Default Setting	Possible Settings
Audio DRC	Off	<ul style="list-style-type: none"> • Off • On
Dolby Digital Out	Dolby Digital	<ul style="list-style-type: none"> • Dolby Digital • Dolby Digital ▶ PCM
DTS Out	DTS ▶ PCM	<ul style="list-style-type: none"> • DTS • DTS ▶ PCM
Linear PCM Out	Down Sample On	<ul style="list-style-type: none"> • Down Sample On • Down Sample Off
MPEG Out	MPEG ▶ PCM	<ul style="list-style-type: none"> • MPEG • MPEG ▶ PCM
Digital Out*	On	<ul style="list-style-type: none"> • On • Off
SACD Playback*	2ch Area	<ul style="list-style-type: none"> • 2ch Area • Multi-ch Area • CD Area

* These parameters only appear when the Setup menu is displayed in expert mode (3-9 and 3-42).

These settings are recommended when the RT-10 is connected to an MC-12 or MC-8 Digital Controller. When no setting is indicated, any setting can be selected.

... Audio1 continues on page 3-12

Audio1 (continued from page 3-11)**Audio DRC (Dynamic Range Control)** Off, On

Controls the dynamic range of Dolby Digital-encoded sources. When On is selected, the RT-10 reduces the dynamic range of high-level peaks. As a result, low-level sounds become more audible. When Off is selected, the RT-10 maintains the original dynamic range of low- and high-level sounds.

Note:

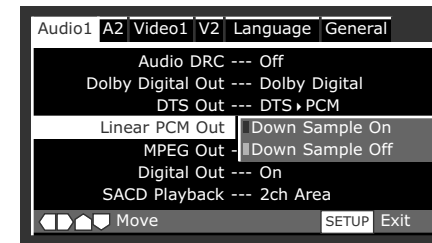
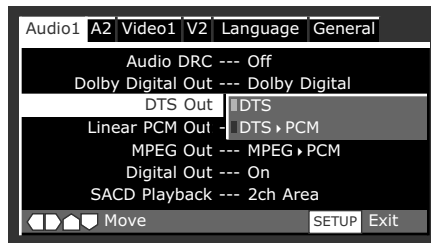
This parameter is only effective with Dolby Digital-encoded DVDs. Its effectiveness varies depending on the loaded disc, the speaker configuration, and associated component settings.

Dolby Digital Out Dolby Digital, Dolby Digital ▶ PCM

Controls Dolby Digital audio output format when a Dolby Digital source is present and the RT-10 is using the digital audio output connector.

Select Dolby Digital if the associated component is compatible with Dolby Digital sources. The RT-10 will pass Dolby Digital signals directly to the associated component. Select Dolby Digital ▶ PCM if the associated component is not compatible with Dolby Digital sources. The RT-10 will convert Dolby Digital signals to PCM before passing them to the associated component.

The Dolby Digital Out parameter is associated with the Setup Navigator Digital Jack prompt (3-7). The Dolby Digital Out parameter and Digital Jack prompt settings have no effect when the RT-10 is not using the digital audio output connector.



DTS Out

DTS, DTS ▶ PCM

Controls DTS audio output format when a DTS source is present and the RT-10 is using the digital audio output connector.

Select DTS if the associated component is compatible with DTS sources. The RT-10 will pass DTS signals directly to the associated component. Select DTS ▶ PCM if the associated component is not compatible with DTS sources. The RT-10 will convert DTS signals to PCM before passing them to the associated component.

Associated components that are NOT compatible with DTS sources will output DTS noise when all of the following conditions are met:

- A DTS source is present.
- The Digital Jack prompt is set to Dolby Digital/DTS or Dolby D/DTS/MPEG OR the DTS Out parameter is set to DTS.

The DTS Out parameter is associated with the Setup Navigator Digital Jack prompt (3-7). The DTS Out parameter and Digital Jack prompt settings have no effect when the RT-10 is not using the digital audio output connector.

Linear PCM Out

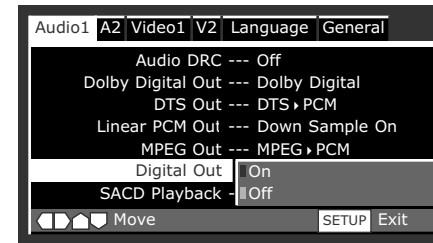
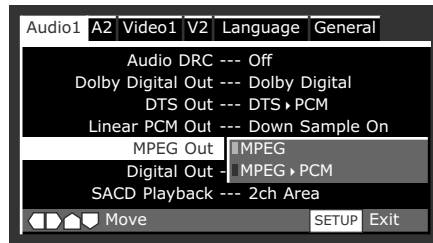
Down Sample On, Down Sample Off

Controls PCM digital audio output format when a 96kHz PCM digital audio source is present and the RT-10 is using the digital audio output connector.

Select Down Sample On if the associated component is not compatible with 96kHz PCM sources. The RT-10 will downsample 96kHz PCM signals to 48kHz before passing them to the associated component. Select Down Sample Off if the associated component is compatible with 96kHz PCM sources. The RT-10 will not downsample 96kHz PCM signals before passing them to the associated component.

... Audio1 continues on page 3-14

Audio1 (continued from page 3-13)



Linear PCM Out (continued)

The Linear PCM Out parameter is associated with the Setup Navigator 96kHz PCM Audio prompt (3-8). The Linear PCM Out parameter and 96kHz PCM Audio prompt settings have no effect when the RT-10 is not using the digital audio output connector.

Note:

The RT-10 always downsamples 192 and 176kHz signals to 96 and 88.2kHz before passing them to the associated component, regardless of the Linear PCM Out parameter and Setup Navigator 96kHz PCM Audio prompt settings.

MPEG Out

MPEG, MPEG ▶ PCM

Controls MPEG audio output format when an MPEG source is present and the RT-10 is using the digital audio output connector.

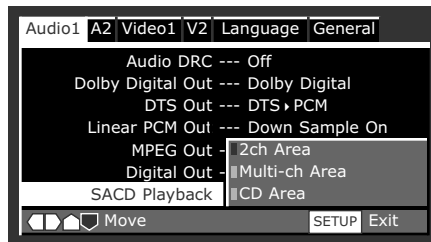
Select MPEG if the associated component is compatible with MPEG sources. The RT-10 will pass MPEG signals directly to the associated component. Select MPEG ▶ PCM if the associated component is not compatible with MPEG sources. The RT-10 will convert MPEG signals to PCM before passing them to the associated component.

The MPEG Out parameter is associated with the Setup Navigator Digital Jack prompt (3-7). The MPEG Out parameter and Digital Jack prompt settings have no effect when the RT-10 is not using the digital audio output connector.

Digital Out

On, Off

Activates and deactivates the RT-10 digital audio output connector. Select On to activate the digital audio output connector. Select Off to deactivate the digital audio output connector.



SACD Playback 2ch Area, Multi-ch Area, CD Area




Controls SACD output format when an SACD is loaded and the RT-10 is using the digital audio output connector. This parameter setting has no effect when another disc format is loaded.

SACDs can include up to three different audio tracks – a stereo track, a multi-channel track, and, on hybrid SACDs, a 16-bit, 44kHz PCM (standard CD) track. Select 2ch Area to select the stereo track for playback. Select Multi-ch Area to select the multi-channel track for playback. Select CD Area to select the standard CD track for playback.


If the selected track is not available on the loaded SACD, the RT-10 will automatically select an alternate track. For instance, if the SACD Playback parameter is set to CD Area and a non-hybrid SACD is loaded, the RT-10 will automatically select the stereo track.

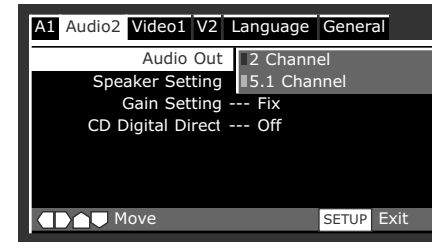
AUDIO2

Includes parameters that control analog audio output format.

Parameter	Default Setting	Possible Settings
Audio Out	2 Channel	<ul style="list-style-type: none"> • 2 Channel • 5.1 Channel 
Speaker Setting	N/A	N/A
Gain Setting*	Fix 	<ul style="list-style-type: none"> • Fix  • Variable
CD Digital Direct*	Off	<ul style="list-style-type: none"> • On • Off

* These parameters only appear when the Setup menu is displayed in expert mode (3-9 and 3-42).

 These settings are recommended when the RT-10 is connected to an MC-12 or MC-8 Digital Controller. When no setting is indicated, any setting can be selected.



Audio Out 2 Channel, 5.1 Channel

Controls analog audio output format when the RT-10 is using the analog audio output connectors.

When 2 Channel is selected, the RT-10 passes analog audio sources to the Front L/R analog audio output connectors. When 5.1 Channel is selected, the RT-10 passes analog audio sources to the Front L/R, Surround L/R, Center, and Sub analog audio output connectors. Refer to the table on the next page for more information.

The Audio Out parameter is associated with the Setup Navigator Analog Jacks prompt (3-7). The Analog Jacks prompt and Audio Out parameter settings have no effect when the RT-10 is not using the analog audio output connectors.

Note:

The Audio Out parameter and Setup Navigator Analog Jacks prompt can be used to select the desired audio output format as long as a compatible audio track is selected on the loaded disc.

Source		Audio Out Parameter	Analog Audio Output				Digital Audio Output	
			Front L/R	Center	Surround L/R	Subwoofer	Dolby Digital or MPEG ▶ PCM	Dolby Digital or MPEG
D V D - V	Dolby Digital-encoded	2 Channel	2-channel downmix	Mute	Mute	Mute	2-channel downmix (Front L/R)	Dolby Digital
		5.1 Channel	Front L/R	Center	Surround L/R	Subwoofer		
	Dolby Digital-encoded (Karaoke)	2 Channel	Front L/R	Mute	Mute	Mute	2-channel downmix (Front L/R)	Dolby Digital
		5.1 Channel						
	dts-encoded	2 Channel	2-channel downmix	Mute	Mute	Mute	2-channel downmix (Front L/R)	2-channel downmix (Front L/R)
		5.1 Channel	Front L/R					
	MPEG-encoded	2 Channel	Front L/R	Mute	Mute	Mute	2-channel downmix (Front L/R)	MPEG
		5.1 Channel		Center	Surround L/R	Subwoofer		
	DVD-A	2 Channel	2-channel downmix	Mute	Mute	Mute	2-channel downmix (Front L/R)	2-channel downmix (Front L/R)
		5.1 Channel	Front L/R	Center	Surround L/R	Subwoofer		
DVD-RW/R	2 Channel	Front L/R	Mute	Mute	Mute	Dolby Digital, PCM, or MPEG	Dolby Digital, PCM, or MPEG	
	5.1 Channel							
CD, SVCD, MP3	2 Channel	Front L/R	Mute	Mute	Mute	Front L/R	Front L/R	
	5.1 Channel							
SACD	2 Channel	2-channel downmix	Mute	Mute	Mute	Mute	Mute	
	5.1 Channel	Front L/R						

... Audio2 continues on page 3-18

Audio2 (continued from page 3-17)

Speaker Setting

Start

Opens the Speaker Setting screens, which can be used to set speaker sizes and distances when the RT-10 is using the 5.1-channel analog audio output connectors. Speaker size and distance settings have no effect when the RT-10 is using the 2-channel analog audio output connectors or digital audio output connector.

Note:

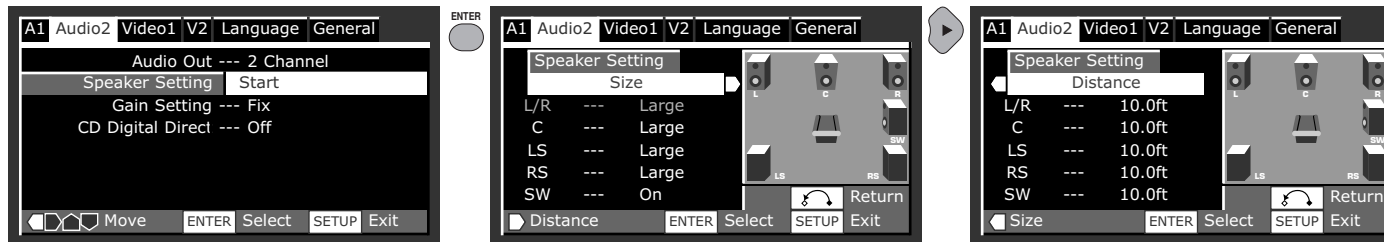
RT-10 speaker settings do not need to be configured when the RT-10 is connected to an associated component such as the MC-12 Digital Controller, which allows speaker settings to be configured for analog audio sources. The associated component must not be using analog audio connections in bypass.

Parameter	Default Size Setting	Possible Size Settings	Default Distance Setting	Possible Distance Settings
L/R	Large†	<ul style="list-style-type: none"> • Large† 	10.0ft	<ul style="list-style-type: none"> • 1.0 to 30.0ft
C*	Large	<ul style="list-style-type: none"> • Small • Large • Off 	10.0ft	<ul style="list-style-type: none"> • 1.0 to 36.5ft
LS*	Large	<ul style="list-style-type: none"> • Small • Large • Off 	10.0ft	<ul style="list-style-type: none"> • 1.0 to 36.5ft
RS*	Large	<ul style="list-style-type: none"> • Small • Large • Off 	10.0ft	<ul style="list-style-type: none"> • 1.0 to 36.5ft
SW*	On	<ul style="list-style-type: none"> • On • Off 	10.0ft	<ul style="list-style-type: none"> • 1.0 to 36.5ft

These settings are recommended when the RT-10 is connected to an MC-12 or MC-8 Digital Controller. When no setting is indicated, any setting can be selected.

* These Speaker Setting parameters are associated with the Setup Navigator Center Speaker (3-6), Surround Speakers (3-6), and Sub-woofer (3-7) prompts.

† The L/R size parameter setting cannot be adjusted. This parameter has a fixed Large setting to provide full-range audio output through the front left and right channels.



Setting Speaker Sizes

The Speaker Size screen shown above can be used to set speaker sizes and crossover points for the front, center, surround, and subwoofer speakers. Refer to the manufacturer documentation to determine the low-frequency response of each speaker.

Note:

Speaker size settings have no effect when:

- A DVD-A is loaded.
- The RT-10 is using the 2-channel analog audio output connectors.
- The RT-10 is using the digital audio output connector.

To set speaker sizes and crossover points:

1. When the Speaker Size screen opens, press the remote control ▲ and ▼ arrows to highlight the desired parameter.

2. When the desired parameter is highlighted, press the ◀ and ▶ arrows to cycle through available settings.
3. When the desired setting is selected, press the ▲ arrow to highlight the Size option at the top of the on-screen display. Then, pressing the ▶ arrow to open the Speaker Distance screen or the remote control ENTER button to return to the Setup menu.

Note the following:

- When setting the C, LS, and RS parameters, select Small to apply a 100Hz crossover point through the associated channel(s). Select Large to provide full-range audio output through the associated channel(s). Select Off if the associated speaker is not present.
- If the low-frequency response of the associated speaker cannot be determined, select Small if the main cone of the associated speaker is less than 6 inches (12cm). Select Large if the main cone of the associated speaker is greater than 6 inches (12cm).

... Audio2 continues on page 3-20

Audio2 (continued from page 3-19)**Setting Speaker Sizes** (continued)**Note the following:**

- The SW parameter determines the presence or absence of a subwoofer. Select On if a subwoofer is present. The RT-10 will pass subwoofer signals and LFE signals for which the corresponding Speaker Size parameter is set to Small to the Sub analog audio output connector. Select Off if no subwoofer is present. The RT-10 will not redirect LFE signals to other analog audio output connectors.
- When speaker size parameters are set to Off, the corresponding speaker distance parameters cannot be adjusted.
- The L/R parameter size setting cannot be adjusted. This parameter has a fixed Large setting to provide full-range audio output through the front left and right channels.
- Because surround speakers must be the same size, the LS and RS parameters cannot be set to different sizes. When the setting of one parameter is adjusted, the setting of the other parameter is automatically adjusted at the same time.

Setting Speaker Distances

The Speaker Distance screen shown at the top of the previous page can be used to set speaker distances for the front, center, surround, and subwoofer speakers.

Note:

Speaker distance settings have no effect when:

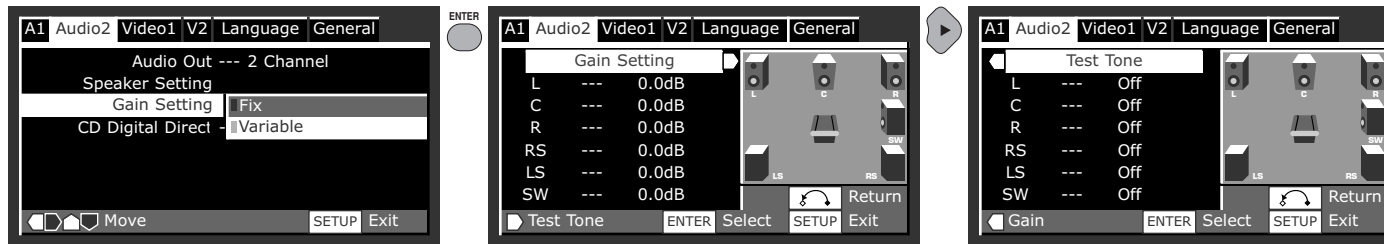
- An SACD is loaded.
 - The RT-10 is using the 2-channel analog audio output connectors.
 - The RT-10 is using the digital audio output connector.
-

To set speaker distances:

1. When the Speaker Size screen opens, press the remote control ▶ arrow to open the Speaker Distance screen.
2. When the Speaker Distance screen opens, press the ▲ and ▼ arrows to highlight the desired parameter.
2. When the desired parameter is highlighted, press the ◀ and ▶ arrows to cycle through available settings.
3. When the desired setting is selected, press the ▲ arrow to highlight the Distance option at the top of the on-screen display. Then, pressing the ◀ arrow to open the Speaker Size screen or the remote control ENTER button to return to the Setup menu.

Note the following:

- To determine the appropriate setting for each speaker, measure the distance between the listening position and the front baffle of the speaker. Then, set the associated speaker distance parameter to the closest available value.



- The L/R distance parameter setting affects all other speaker distance parameter settings. The C and SW parameters must be set within 6.5 feet (2m) of the L/R parameter, and the LS and RS parameters must be set within 20 feet (6m) of the L/R parameter.
- When the L/R parameter setting is increased, other parameter settings automatically increase in 0.5-foot increments within their respective ranges. Likewise, when the L/R parameter setting is decreased, other parameter settings automatically decrease in 0.5-foot increments within their respective ranges.
- It is recommended to select the closest available setting when the subwoofer distance falls outside the SW parameter range. This should not affect surround cohesion.

Gain Setting

Fix, Variable

Controls front, center, surround, and subwoofer channel output levels when the RT-10 is using the 5.1-channel analog audio output connectors. This parameter setting has no effect when the RT-10 is using the 2-channel analog audio output connectors or digital audio output connector.

Selecting Fix configures all channels to pass audio at its relative recorded volume level. Selecting Variable opens the Gain Setting screens, which can be used to adjust output levels within a -6.0 to $+6.0$ dB range.

Note the following:






- The Gain Setting parameter setting has no effect when the CD Digital Direct parameter (3-24) is set to On and a CD source is present.
- When Variable is selected, output levels can be calibrated for the analog audio output connectors. Variable output levels do not affect the digital audio output connector.
- In some cases, variable output levels might sound quieter than fixed output levels.


Setting Variable Output Levels

The Gain Setting and Test Tone screens shown above can be used to calibrate variable output levels for the front, center, surround, and subwoofer speakers.

... Audio2 continues on page 3-22

Audio2 (continued from page 3-21)

Parameter	Default Gain Setting	Possible Gain Settings	Default Test Tone Setting	Possible Test Tone Settings
L/R	0.0dB 	• -6.0 to +6.0dB	Off	• Auto • On • Off
C	0.0dB 	• -6.0 to +6.0dB	Off	• Auto • On • Off
LS	0.0dB 	• -6.0 to +6.0dB	Off	• Auto • On • Off
RS	0.0dB 	• -6.0 to +6.0dB	Off	• Auto • On • Off
SW	0.0dB 	• -6.0 to +6.0dB	Off	• Auto • On • Off

 These settings are recommended when the RT-10 is connected to an MC-12 or MC-8 Digital Controller. When no setting is indicated, any setting can be selected.

Note:

RT-10 variable output levels do not need to be configured when the RT-10 is connected to an associated component such as the MC-12 or MC-8 Digital Controller, which allows output levels to be calibrated for analog audio sources.

Before output level calibration begins:

- It is recommended to use a Sound Pressure Level (SPL) meter to calibrate variable output levels. An SPL meter is a device that measures the relative loudness of each speaker to ensure accurate output level calibration. SPL meters are available at Radio Shack (catalog no. 33-2050).

- Eliminate extraneous noises in the listening space such as conversations, air conditioners, and sounds that filter in through open doors and windows.
- Remove objects (including people) that obstruct the line-of-sight path between the SPL meter and the speaker being measured.
- Output levels should be calibrated to be consistent from the primary listening position. Place the SPL meter at the approximate spot where the listener's head will be during listening.

To set variable output levels:

1. When the Gain Setting screen opens, press the remote control **▶** arrow to open the Test Tone screen shown on page 3-21.
2. When the Test Tone screen opens, press the **▲** and **▼** arrows to highlight the desired parameter.
 - Test Tone parameters cannot be adjusted when the disc drawer is open, the Audio Out parameter or Setup Navigator Analog Jacks prompt is set to 2 Channel, or the RT-10 is in playback, pause, or resume mode. (The RT-10 must be in stop mode.)
3. When the desired parameter is highlighted, press the **◀** and **▶** arrows to cycle through the Auto, On, and Off settings.
 - Select Auto to set all test tone parameters to Auto. Test tones will pass through each channel when the associated Gain Setting screen parameter is highlighted.
 - Select On to activate a test tone for the associated channel. A test tone will pass through the associated channel when the corresponding Gain Setting screen parameter is highlighted.

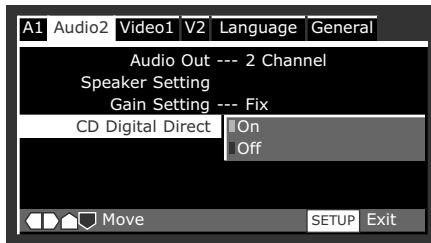
- Select Off to deactivate a test tone for the associated channel. No test tone will pass through the associated channel.
4. Repeat steps 2 and 3 until all desired test tones have been activated or deactivated.
 5. When all desired test tones have been activated, press the **▲** and **▼** arrows to highlight the Test Tone option at the top of the screen. Then, press the **◀** arrow to reopen the Gain Setting screen.
 6. When the Gain Setting screen opens, press the **▲** and **▼** arrows to highlight the desired parameter. If the corresponding test tone parameter has been set to Auto or On, a test tone will pass through the associated channel.
 - To hear the test tone again, press the **▲** and **▼** arrows to reselect the parameter.

Note:

Test tones automatically mute when the Lexicon screen saver appears on the on-screen display. To avoid this, set the Screen Saver parameter (3-28) to Off while variable output levels are calibrated. Test tones also mute when playback mode is activated.

7. When the desired parameter is highlighted, press the **◀** and **▶** arrows to cycle through available settings.
8. When the desired setting is selected, press the **▲** and **▼** arrows to highlight the Gain Setting option at the top of the on-screen display. Then, press the remote control ENTER button to return to the Setup menu.

Audio2 (continued from page 3-23)



CD Digital Direct On, Off

Prevents DTS-encoded CDs from outputting digital noise. This parameter has no effect on other disc formats and input sources.

When On is selected, the RT-10 prevents DTS-encoded CDs from outputting digital noise. When Off is selected, the RT-10 might not prevent DTS-encoded CDs from outputting digital noise.

Note:

The Gain Setting parameter setting has no effect when the CD Digital Direct parameter is set to On and a CD source is present.

VIDEO1

Includes parameters that control video output format, as well as the Time and Frame + Time search modes and the Lexicon screen saver.

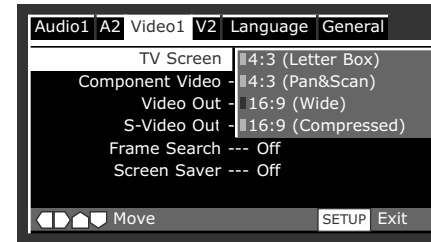
Parameter	Default Setting	Possible Settings
TV Screen	16:9 (Wide)	<ul style="list-style-type: none"> • 4:3 (Letter Box) • 4:3 (Pan&Scan) • 16:9 (Wide) • 16:9 (Compressed)
Component Video	Interlace	<ul style="list-style-type: none"> • Progressive • Interlace
Video Out	Video	<ul style="list-style-type: none"> • Video • S-Video • RGB
S-Video Out	S2	<ul style="list-style-type: none"> • S1 • S2
Frame Search*	Off	<ul style="list-style-type: none"> • On • Off
Screen Saver*	Off	<ul style="list-style-type: none"> • On • Off











* These parameters only appear when the Setup menu is displayed in expert mode (3-9 and 3-42).

TV Screen

Refer to the table on the previous page

Controls the appearance of the picture on the associated display device screen, formatting the aspect ratio of the video output format to match the aspect ratio of the display device. Aspect ratios, which refer to width relative to height, differ among video output formats and display devices. A 16:9 aspect ratio is almost twice as wide as high and a 4:3 aspect ratio is almost square.



Video Recording Format	TV Screen Parameter	Display Device Aspect Ratio	Display Device Setting	Appearance
16:9 	4:3 (Letter Box)	4:3	N/A	 The picture appears between black bars at the top and bottom of the screen.
16:9 	4:3 (Pan&Scan)	4:3	N/A	 The picture appears cropped at the sides, allowing the picture to fill the screen. Although the picture on the screen might seem larger, less of the picture is actually visible.
16:9 	16:9 (Wide)	4:3	N/A	 The picture appears "squashed." It is recommended to set the TV Screen parameter to 4:3 (Letter Box) or 4:3 (Pan&Scan)
4:3 	4:3 (Letter Box) 4:3 (Pan&Scan) 16:9 (Wide)	4:3	N/A	 The picture appears as intended regardless of the TV Screen parameter setting.
16:9 	16:9 (Wide)	16:9	Normal (4:3)	 The picture appears "squashed." It is recommended to set the display device to Full (16:9).

... Video1 continues on page 3-26

Video1 (continued from page 3-25)

TV Screen (continued)









Select 16:9 (Wide) or 16:9 (Compressed) if the associated display device screen has a 16:9 aspect ratio. Select Standard 4:3 (Letter Box) or 4:3 (Pan&Scan) if the associated display device screen has a 4:3 aspect ratio. The appearance of the picture depends on the TV Screen parameter or TV Type prompt setting, the video output format, the loaded disc, and display device settings.

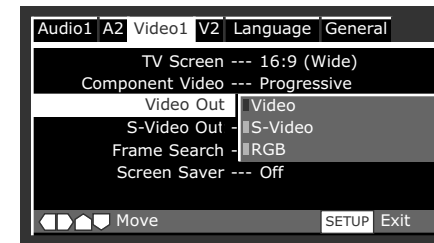
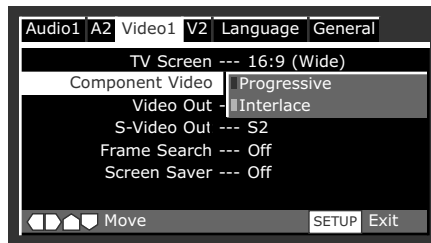
The TV Screen parameter is associated with the Setup Navigator TV Type prompt (3-5). The TV Type prompt Widescreen (16:9) setting is equivalent to the TV Screen parameter 16:9 (Wide)

setting, and the TV Type prompt Standard (4:3) setting is equivalent to the TV Screen parameter 4:3 (Letter Box) setting. The TV Screen parameter also offers settings for 16:9 (Compressed) and 4:3 (Pan&Scan) viewing. Refer to the table on pages 3-25 and below for more information.

Note:

- Some discs do not allow video output format adjustments.
- Neither the TV Screen parameter nor the TV Type prompt can be adjusted when the RT-10 is in playback mode.

Video Recording Format	TV Screen Parameter	Display Device Aspect Ratio	Display Device Setting	Appearance
16:9 	16:9 (Wide)	16:9	Full (16:9)	 Images appear in widescreen (16:9) format.
4:3 	16:9 (Wide)	16:9	Normal (4:3)	 Images appear between black bars at either side of the screen.
4:3 	16:9 (Wide)	16:9	Full (16:9)	 Images appear stretched across the screen. It is recommended to set the display device to Normal (4:3).
4:3 	16:9 (Compressed)	16:9	Full (16:9)	 Images appear between black bars at either side of the screen. This setting is recommended for display devices with a fixed aspect ratio and a progressive-scan component video input connector.



Component Video

Progressive, Interlace

Controls component video output format when the RT-10 is using the component video output connectors. Select Progressive if the associated display device provides a progressive-scan component video input connector. Select Interlace if the associated display device does not provide a progressive-scan component video input connector.

When Progressive is selected:

- The picture might appear stretched on the associated display device screen if a video source recorded in 4:3 format is present and the RT-10 or the display device is configured for a 16:9 aspect ratio. To correct this, configure the RT-10 or the display device for a 4:3 aspect ratio. Refer to the TV Screen parameter description on page 3-25 and the table on pages 3-25 and 3-26 for more information.
- The picture will not appear on the associated display device screen if the display device does not provide a progressive-scan component video input connector. To correct this, set the Component Video parameter to Interlace and configure the RT-10 for a different video output connection to the display device.

- The RT-10 converts video sources recorded on film to 60 frames-per-second to create a more natural picture. Refer to the Pure Cinema parameter description on page 3-30 for more information.
- **Progressive-scan component video output is only available for NTSC discs.**

Note:

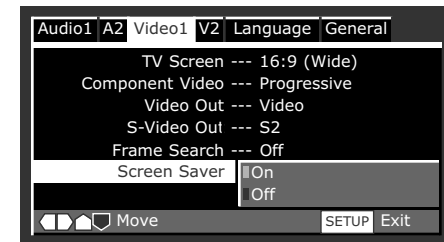
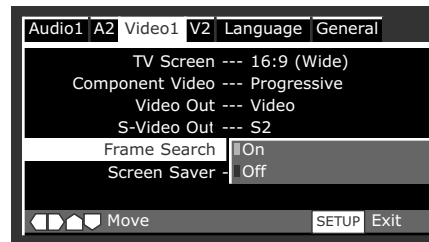
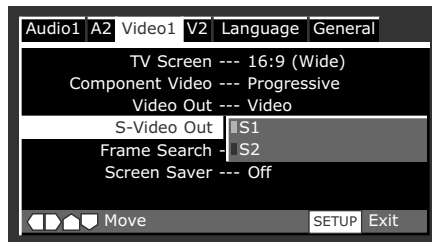
The RT-10 is not compatible with all high-definition display devices, which might produce video artifacts in the picture.

Video Out

Video, S-Video, RGB

Controls video output format when the RT-10 is using the Euro or Peritel (TV A/V) connector. When Video is selected, the RT-10 passes composite video signals to the associated display device. When S-Video is selected, the RT-10 passes S-video signals to the associated display device. When RGB is selected, the RT-10 passes RGB and composite video signals to the associated display device. The composite video signals serve as sync.

... Video1 continues on page 3-28

Video1 (continued from page 3-27)**S-Video Out** S1, S2

Determines the trigger control signal present when the RT-10 is using the S-video output connector, providing control of anamorphic display switching. Select the S1 setting to enable automatic switching between 16:9 and 4:3 video output formats. Select the S2 setting to enable automatic switching between 16:9, 4:3 standard, and 4:3 letter box video output formats.

The S-Video Out parameter controls anamorphic display switching when all of the following conditions are met:

- The RT-10 has an S-video output connection to the associated display device.
- The associated display device is compatible with the selected anamorphic trigger control signal.
- The loaded disc supports the selected anamorphic trigger control signal.

It is recommended to toggle between the S1 and S2 settings if the picture appears stretched or otherwise distorted on the display device screen.

Frame Search On, Off

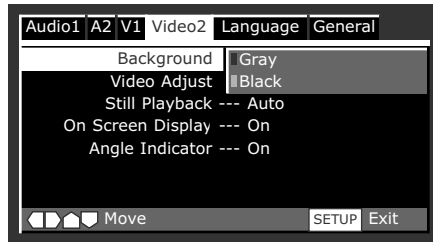
Enables and disables the time and time & frame search modes (4-28). When On is selected, these search modes are enabled for compatible disc formats. When Off is selected, these search modes are disabled for all disc formats.

Screen Saver On, Off

Activates and deactivates the Lexicon screen saver. When On is selected, the Lexicon screen saver appears on the on-screen display when a still frame image has appeared on the display device screen for more than 5 minutes. When Off is selected, the Lexicon screen saver does not appear on the on-screen display.

Note:

Still frame images displayed on CRT display devices for long periods of time can "burn in" or create "ghost images" on the screen. When the RT-10 is connected to a CRT display device, it is recommended to set the Screen Saver parameter to On to prevent the appearance of "ghost images" on the screen.



The loaded disc might cause the Video Adjust bar to exceed on-screen display margins. If this occurs, close the Video Adjust bar and remove the loaded disc from the disc drawer. Then, open the Video Adjust bar again.

VIDEO2

Includes parameters that control video output format and on-screen display appearance.

Parameter	Default Setting	Possible Settings
Background	Gray	<ul style="list-style-type: none"> • Gray • Black
Video Adjust	N/A	N/A
Still Picture*	Auto	<ul style="list-style-type: none"> • Field • Frame • Auto
On-Screen Display*	On	<ul style="list-style-type: none"> • On • Off
Angle Indicator*	Off	<ul style="list-style-type: none"> • On • Off

* These parameters only appear when the Setup menu is displayed in expert mode (3-9 and 3-42).

Background

Gray, Black

Determines the background color of Setup menu screens when resume or stop mode is activated. The video output signal appears behind Setup menu screens when playback or pause mode is activated.

Video Adjust

Start

Opens the Video Adjust bar shown above, which can be used to make exact, detailed adjustments of video settings such as luminance (YNR), chrominance (CNR), mosquito (MNR), and black (BNR) noise reduction, as well as sharpness, white, black, gamma, hue, and chroma levels. Refer to the Video Adjust parameter descriptions that begin on the next page for more information.

Note:

The remote control VIDEO ADJ button can also be used to open the Video Adjust bar.

... Video2 continues on page 3-30

Video2 (continued from page 3-29)**Pure Cinema** Auto1, Auto2, On, Off

Controls DVD-V frame rate to simulate cinema screen picture quality. Video sources can be recorded on video or film. Sources recorded on video have a 30 frames-per-second (NTSC) rate, and sources recorded on film have a 24 frames-per-second rate. When the Component parameter is set to Progressive, the RT-10 converts sources recorded on film to 60 frames-per-second to create a more natural picture.

Select Auto1 for most video sources. If the picture on the display device screen appears unnatural, select another setting. Repeat this process to achieve the best picture quality.

YNR (Luminance Noise Reduction) off to max

Controls the amount of noise reduction applied to the Y component (luminance) present in video signals.

CNR (Chrominance Noise Reduction) off to max

Controls the amount of noise reduction applied to the C component (chrominance) present in video signals.

MNR (Mosquito Noise Reduction) off to max

Controls the amount of noise reduction applied to mosquito (dot crawl) noise present in video signals, which produces video artifacts around picture edges as a result of MPEG compression.

BNR (Black Noise Reduction) off to max

Controls the amount of noise reduction applied to black noise present in video signals.

Sharpness High soft to fine

Controls the sharpness of high-frequency (finely detailed) video signals.

Sharpness Mid soft to fine

Controls the sharpness of mid-frequency (less detailed) video signals.

Detail off to max

Controls the sharpness of details around picture edges.

White Level min to max

Controls the white level of video signals.

Black Level min to max

Controls the black level of video signals.

Black Setup 0 IRE, 7.5 IRE

Corrects floating black color. Settings are based on International Radio Engineer (IRE) units: 0 IRE is equivalent to 0.286V and 7.5 IRE is equivalent to 0.339V.

Parameter	Default Setting			Possible Settings
	TV (CRT)	PDP	Professional	
Pure Cinema	Auto1	Auto1	Auto1	Auto1, Auto2, On, Off
YNR	4	4	2	off to max (8 increments)
CNR	4	4	2	off to max (8 increments)
MNR	0	0	0	off to max (8 increments)
BNR	0	0	0	off to max (8 increments)
Sharpness High	4	2	4	soft to fine (8 increments)
Sharpness Mid	4	2	4	soft to fine (8 increments)
Detail	6	0	2	off to max (8 increments)
White Level	4	4	4	min to max (8 increments)
Black Level	4	4	4	min to max (8 increments)
Black Setup	7.5 IRE	7.5 IRE	7.5 IRE	0 IRE, 7.5 IRE
Gamma	4	4	4	+ to – (8 increments)
Hue	4	4	4	green to red (8 increments)
Chroma Level	4	4	4	min to max (8 increments)
Chroma Delay	4	4	4	+ to – (8 increments)
Memory	Off	Off	Off	Off, 1, 2, 3
Prog. Motion	4	4	4	fast to slow (8 increments)

The RT-10 is manufactured for sale in several different countries. The default Video Adjust parameter settings listed in the table shown above might differ among versions.

... Video2 continues on page 3-32

Video2 (continued from page 3-31)



Video Adjust (continued)

Gamma + to -
Controls the brightness of darker picture elements.

Hue green to red
Controls the red-to-green color balance of video sources.

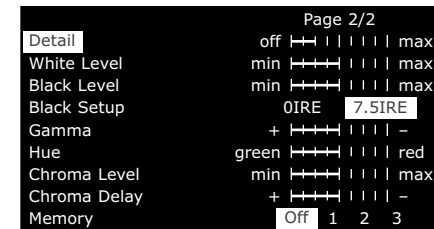
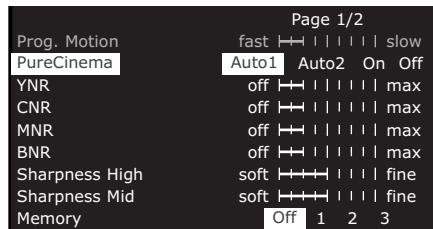
Chroma Level min to max
Controls the color saturation of video sources.

Chroma Delay min to max
Compensates for misalignment of the Y (luminance) and C (chrominance) components present in video signals.

Memory Off, 1, 2, 3
Determines the memory bank in which user-defined Video Adjust settings are stored. The RT-10 includes three memory banks called 1, 2, and 3.

To configure and store memory banks:

1. Press the remote control VIDEO ADJ button to open the Video Adjust bar shown above (first column, first row).



2. When the Video Adjust bar opens, press the remote control ▲ and ▼ arrows to highlight the Video Setup option. Then, press the remote control ENTER button to select this option.
3. When the Video Setup bar opens:
 - Proceed to step 4 to configure memory banks from the Video Setup bars shown on the previous page. The Video Setup bars allow Video Adjust parameters to be viewed on 17 separate bars.
 - Press the remote control DISPLAY button to configure memory banks from the Video Setup screens shown above. The Video Setup screens allow Video Adjust parameters to be viewed on two screens.
4. When the desired Video Setup view is selected, press the ▲ and ▼ arrows to scroll through Video Adjust parameters.
 - When a Video Setup bar is open, the selected parameter appears on the bar.
 - When a Video Setup screen is open, the selected parameter is highlighted. The cursor automatically toggles between the two screens when the last parameter on Page 1/2 or the first parameter on Page 2/2 is passed.
5. When the desired parameter is selected, press the ◀ and ▶ arrows to adjust the setting. When the desired setting is selected, press the ▲ and ▼ arrows to continue scrolling through Video Adjust parameters.
6. Repeat steps 4 and 5 until all desired parameter settings have been selected.
7. When all desired parameter settings have been selected, press the ▲ and ▼ arrows to select the Memory parameter. Then, press the ◀ and ▶ arrows to highlight the desired memory bank (1, 2, or 3).
8. When the desired memory bank is highlighted, press the ENTER button to select that bank. Its settings will be applied to pictures on the display device screen until another Video Adjust bank is selected or factory-default settings are restored.
 - When Off is selected, the selected settings are applied to the picture on the display device screen until a Video Adjust bank is selected, factory-default settings are restored, or the RT-10 is powered off with the front panel On/Off button.

... Video2 continues on page 3-34

Video2 (continued from page 3-33)**Video Adjust** (continued)**Prog. Motion**

fast to slow

Controls the still picture quality when the RT-10 is using the component video output connectors. This parameter is not available unless the RT-10 is using the component video output connectors.

Selecting Video Adjust Banks

The Video Memory Select bar shown above can be used to select the desired Video Adjust bank. The RT-10 offers six banks of Video Adjust settings, including three preset banks for CRT, plasma, and professional display devices and three memory banks for storage of user-defined Video Adjust settings. The Professional bank is automatically selected when factory-default settings are restored.

To select a Video Adjust bank:

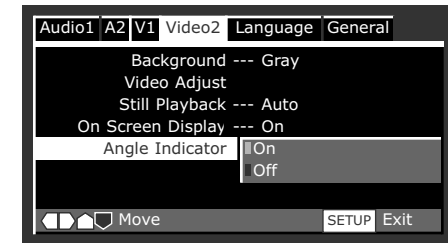
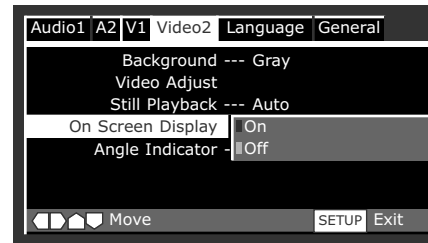
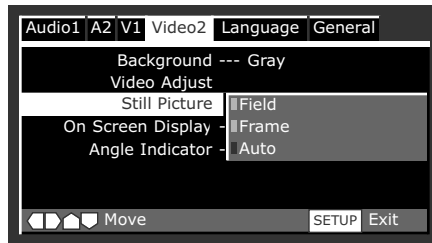
1. Press the remote control VIDEO ADJ button to open the Video Adjust bar shown above (left).
2. When the Video Adjust bar opens, press the remote control ▲ and ▼ arrows to highlight the Video Memory Select option. Then, press the ENTER button to select this option.

3. When the Video Memory Select bar opens, press the ◀, ▶, ▲, and ▼ arrows to highlight the desired Video Adjust bank.
 - When a bank is highlighted, its settings are automatically applied to the picture on the display device screen, allowing for previewing of bank settings. These settings are automatically unapplied when a new bank is selected or the Video Memory Select bar is closed.

Note:

Depending on the loaded disc and the associated display device, previewed Video Adjust bank settings might not be unapplied when a new bank is highlighted. If this occurs, it is required to select a new Video Adjust bank to cancel the previewed settings. The selected bank settings will be automatically applied to the picture on the display device screen.

4. When the desired Video Adjust bank is highlighted, press the ENTER button to select this bank. Its settings will be automatically applied to the picture on the display device screen.






Still Picture Field, Frame, Auto

Controls the appearance of still frame images. When Field is selected, the RT-10 produces tight, stable, and generally shake-free still frame images. When Frame is selected, the RT-10 produces sharper, but shakier still frame images. When Auto is selected, the RT-10 automatically selects the best viewing method for still frame images.

On Screen Display On, Off

Controls the appearance of DVD top menus. When On is selected, pressing the remote control TOP MENU button opens a DVD top menu when the loaded DVD includes a top menu. (In some cases, the remote control MENU button can also be pressed.) When Off is selected, pressing the TOP MENU or MENU button does not open a DVD top menu, even if the loaded DVD includes a top menu. Refer to the Navigating Disc Menus section that begins on page 4-3 for more information.

Angle Indicator On, Off

Activates and deactivates the  indicator. When set to On, the  indicator appears on the front panel display when playback of a scene recorded from multiple camera angles is in progress. When set to Off, the  indicator does not appear on the front panel display when playback of a scene recorded from multiple camera angles is in progress.

Note:

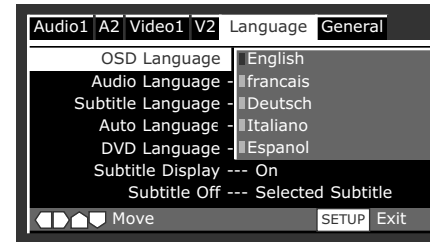
The remote control ANGLE button can be used to select the desired camera angle for scenes recorded from multiple camera angles (4-9).

LANGUAGE

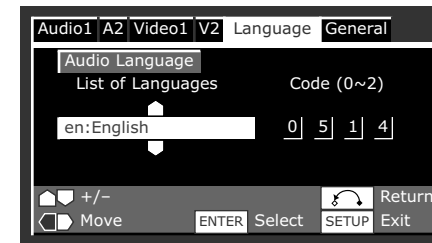
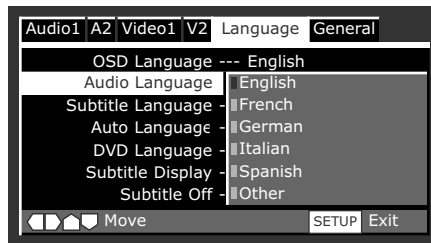
Includes parameters that can be used to determine RT-10 on-screen display menu, disc menu, subtitle, and audio language.

Parameter	Default Setting	Possible Settings
OSD Language	English	<ul style="list-style-type: none"> English français Deutsch Italiano Español
Audio Language	English	<ul style="list-style-type: none"> Refer to the table that begins on page A-14
Subtitle Language	English	<ul style="list-style-type: none"> Refer to the table that begins on page A-14
Auto Language	On	<ul style="list-style-type: none"> On Off
DVD Language*	On	<ul style="list-style-type: none"> w/ Subtitle Language Refer to the table that begins on page A-14
Subtitle Display*	On	<ul style="list-style-type: none"> On Off Assist Subtitle
Subtitle Off*	Selected Subtitle	<ul style="list-style-type: none"> With Audio Selected Subtitle

* These parameters only appear when the Setup menu is displayed in expert mode (3-9 and 3-42).



OSD Language English, français, Deutsch, Italiano, Español
 Determines the language in which RT-10 on-screen display menus appear. The OSD Language parameter is associated with the Setup Navigator OSD Language prompt (3-4).



Audio Language Refer to the table on pages A-14 and A-15. Determines the language in which audio is heard. If the selected audio language is available on the loaded DVD, the RT-10 selects the audio track that includes that language. If the selected audio language is not included on the loaded DVD, the RT-10 selects the default disc audio language.

Select Other to choose a language other than English, French, German, Italian, or Spanish. The DVD format recognizes 136 different languages, which are listed in the table that begins on page A-14. When Other is selected, the Audio Language screen shown above opens on the on-screen display.

To select an "Other" language:

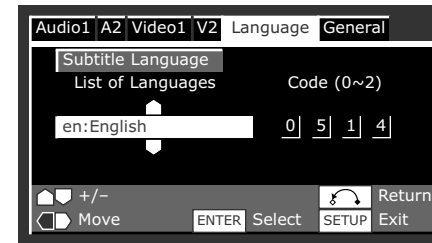
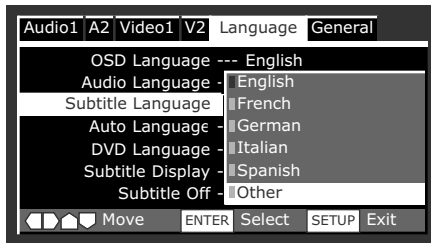
1. When the Audio Language screen opens, use one of the following methods to select the desired language:
 - a. Press the remote control ▲ and ▼ arrows to scroll through the complete list of available languages. When the desired language is highlighted, press the remote control ENTER button to select this language and return to the Language tab.

- b. Press the remote control ▶ arrow to move the cursor to the first character space that appears on the right of the on-screen display. Then, use the remote control number buttons to enter the numeric code for the desired language. Refer to the table that begins on page A-14 to determine the appropriate numeric code. When the desired language is selected, press the remote control ENTER button to return to the Language tab.

Note the following:

- If the Auto Language parameter (3-39) is set to On, the RT-10 automatically selects the default disc audio track, regardless of the Audio Language parameter setting.
- The remote control AUDIO button can be used to select the desired audio track (audio language and output format) on the loaded DVD. Refer to page 4-7 for more information.

... Language continues on page 3-38

Language (continued from page 3-37)

Subtitle Language Refer to the table on pages A-14 and A-15. Determines the language in which subtitles appear. If the selected subtitle language is available on the loaded DVD, the RT-10 selects that language. If the selected subtitle language is not included on the loaded DVD, the RT-10 selects the default disc subtitle language.

Select Other to choose a language other than English, French, German, Italian, or Spanish. The DVD format recognizes 136 different languages, which are listed in the table that begins on page A-14. When Other is selected, the Subtitle Language screen shown above opens on the on-screen display.

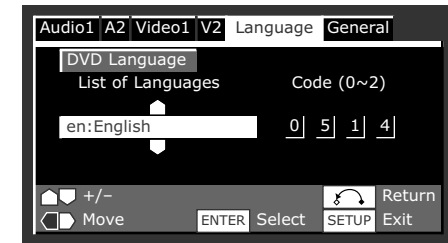
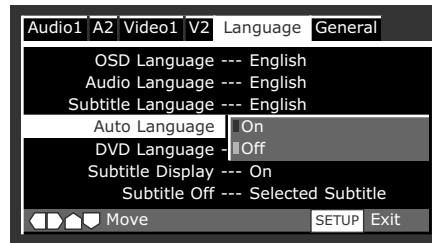
To select an "Other" language:

1. When the Subtitle Language screen opens, use one of the following methods to select the desired language:
 - a. Press the remote control ▲ and ▼ arrows to scroll through the complete list of available languages. When the desired language is highlighted, press the remote control ENTER button to select this language and return to the Language tab.

- b. Press the remote control ▶ arrow to move the cursor to the first character space that appears on the right of the on-screen display. Then, use the remote control number buttons to enter the numeric code for the desired language. Refer to the table that begins on page A-14 to determine the appropriate numeric code. When the desired language is selected, press the remote control ENTER button to return to the Language tab.

Note the following:

- In most cases, subtitles do not appear on the on-screen display when the Subtitle Display parameter (3-40) is set to Off, regardless of the Subtitle Language and Auto Language (next page) parameter settings.
- If the Auto Language parameter is set to On, the RT-10 automatically selects the default disc subtitle language, regardless of the Subtitle Language parameter setting.
- If the loaded disc does not include subtitles, subtitles do not appear on the on-screen display, regardless of Language tab parameter settings.



- The remote control SUBTITLE button can be used to select the desired subtitle language on the loaded DVD. Refer to page 4-8 for more information.

Auto Language

On, Off

Controls audio track and subtitle language selection. When On is selected, the RT-10 automatically selects the default disc audio track and subtitle language, regardless of the Audio Language (3-37) and Subtitle Language (previous page) parameter settings. When Off is selected, the RT-10 selects audio track and subtitle language based on the Audio Language and Subtitle Language parameter settings.

Note the following:

- In most cases, subtitles do not appear on the on-screen display when the Subtitle Display parameter (3-40) is set to Off, regardless of the Subtitle Language (previous page) and Auto Language parameter settings.

- If the loaded disc does not include subtitles, subtitles do not appear on the on-screen display, regardless of Language tab parameter settings.

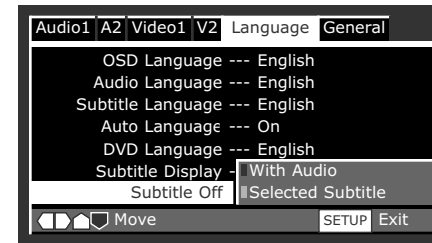
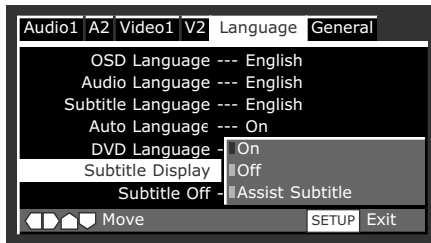
DVD Language

Refer to the table on pages A-14 and A-15

Determines the language in which DVD menus and top menus appear. If the selected DVD menu language is available on the loaded DVD, the RT-10 selects that language. If the selected DVD menu language is not included on the loaded DVD, the RT-10 selects the default disc menu language. When w/ Subtitle Language is selected, DVD menus appear in the selected subtitle language.

Select Other to choose a language other than English, French, German, Italian, or Spanish. The DVD format recognizes 136 different languages, which are listed in the table that begins on page A-14. When Other is selected, the DVD Language screen shown above opens on the on-screen display.

... Language continues on page 3-40

Language (continued from page 3-39)**To select an "Other" language:**

1. When the DVD Language screen opens, use one of the following methods to select the desired language:
 - a. Press the remote control ▲ and ▼ arrows to scroll through the complete list of available languages. When the desired language is highlighted, press the remote control ENTER button to select this language and return to the Language tab.
 - b. Press the remote control ► arrow to move the cursor to the first character space that appears on the right of the on-screen display. Then, use the remote control number buttons to enter the numeric code for the desired language. Refer to the table that begins on page A-14 to determine the appropriate numeric code. When the desired language is selected, press the remote control ENTER button to return to the Language tab.

Note:

Some DVDs allow menu language to be selected from the disc menu. Refer to page 4-3 for more information.

Subtitle Display

On, Off, Assist Subtitle

Controls the appearance of subtitles on the on-screen display. Select On to display subtitles when playback mode is activated. Select Off to prevent subtitles from displaying when playback mode is activated. Select Assist Subtitle to display more extensive subtitles when playback mode is activated.

Note the following:

- In most cases, subtitles do not appear on the on-screen display when the Subtitle Display parameter is set to Off, regardless of the Subtitle Language (3-38) and Auto Language (3-39) parameter settings.

- If the loaded disc does not include subtitles, subtitles do not appear on the on-screen display, regardless of Language tab parameter settings.

Subtitle Off

With Audio, Selected Subtitle

Determines the language in which subtitles appear if the loaded disc displays subtitles when the Subtitle Display parameter (previous page) is set to Off. In most cases, subtitles do not appear on the on-screen display when the Subtitle Display parameter is set to Off, regardless of the Subtitle Language (3-38) and Auto Language (3-39) parameter settings.

Select With Audio to display subtitles in the language selected with the Audio Language parameter. Select Selected Subtitle to display subtitles in the language selected with the Subtitle Language parameter. If the loaded disc does not include the selected subtitle language, the RT-10 selects the default disc subtitle language.

GENERAL

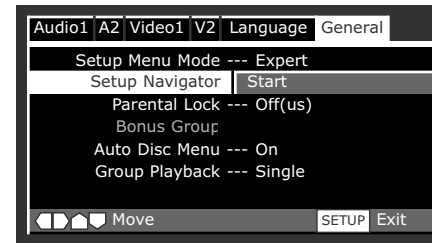
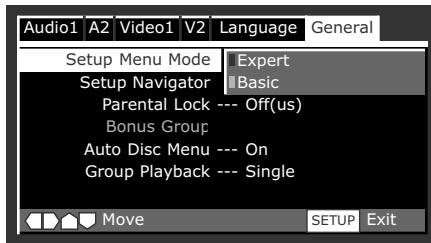
Includes parameters that can be used to configure general RT-10 settings, such as Setup menu display mode, parental lock controls, and DVD-A playback.

Parameter	Default Setting	Possible Settings
Setup Menu Mode	Expert	<ul style="list-style-type: none"> • Expert • Basic
Setup Navigator	N/A	N/A
Parental Lock	N/A	N/A
Bonus Group*	N/A	N/A
Auto Disc Menu*	On	<ul style="list-style-type: none"> • On • Off
Group Playback*	Single	<ul style="list-style-type: none"> • All • Single

* These parameters only appear when the Setup menu is displayed in expert mode (3-9 and 3-42).

. . . General continues on page 3-42

General (continued from page 3-41)



Setup Menu Mode

Expert, Basic

Determines the mode in which the Setup menu is displayed. Select Expert to display the Setup menu in expert mode, which includes all available parameters. The Setup menu is shown in expert mode at the top of page 3-10. Select Basic to display the Setup menu in basic mode, which only includes parameters that are required to configure the most common RT-10 settings. When displayed in basic mode, the Setup menu also includes a tutorial to describe the highlighted menu item. The Setup menu is shown in basic mode at the bottom of page 3-10.

Setup Navigator

Start

Activates and deactivates the Setup Navigator, which can be used to configure basic RT-10 settings without navigating through the entire Setup menu. Select Start to activate the Setup Navigator and proceed to the OSD Language prompt (3-4). The Setup Navigator parameter is associated with the Setup Navigator prompt (3-4).

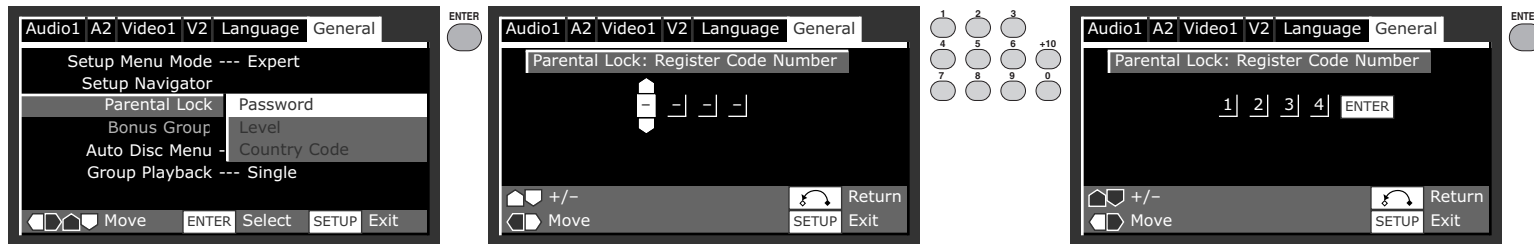
Parental Lock

Password, Level, Country Code

Opens the Password, Level, and Country Code controls, which can be used to assign a user-defined password that must be entered before the RT-10 will activate playback mode when a disc encoded with a user-defined security level is loaded. These controls have no effect when a disc that is not encoded with a security level or country code is loaded.

Control	Default Setting	Possible Settings
Password	None	<ul style="list-style-type: none"> None User-Defined*
Level	off(us)	<ul style="list-style-type: none"> off(country code) 1 to 8
Country Code	us(2119)	<ul style="list-style-type: none"> Refer to the table on page A-16

* A user-defined password must be selected before the Level and Country Code controls can be adjusted.



Password

Assigns a user-defined password that must be entered before the RT-10 will activate playback mode when a disc encoded with a user-defined security level or country code is loaded. A user-defined password must be assigned before the Level and Country Code controls can be adjusted. User-defined passwords are automatically deleted when factory-default settings are restored.

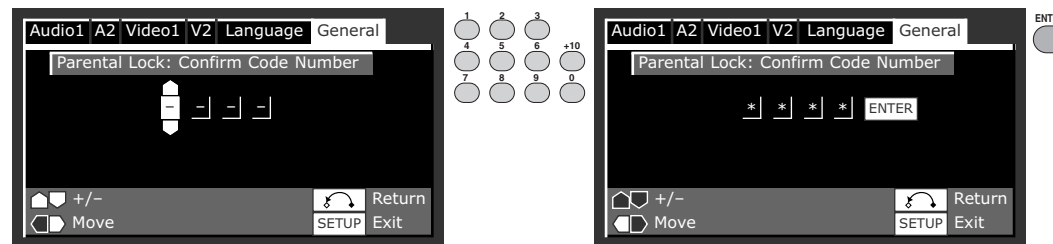
To assign a password:

When the Password parental control is selected for the first time, the Register Code Number screen shown above opens on the on-screen display. This screen can be used to assign a user-defined password.

1. When the Register Code Number screen opens, use the remote control number buttons to enter the desired password. All passwords must consist of four numbers between 0 and 9.
 - When a number is entered, the cursor automatically advances to the next character space. Press the ◀ arrow to return to the previous character space or the ▶ arrow to advance to the next character space.

2. When a four-number password has been entered, an ENTER button appears on the on-screen display to indicate that pressing the remote control ENTER button will assign the entered password.

... General continues on page 3-44

General (continued from page 3-43)**Password** (continued)**To confirm the user-defined password:**

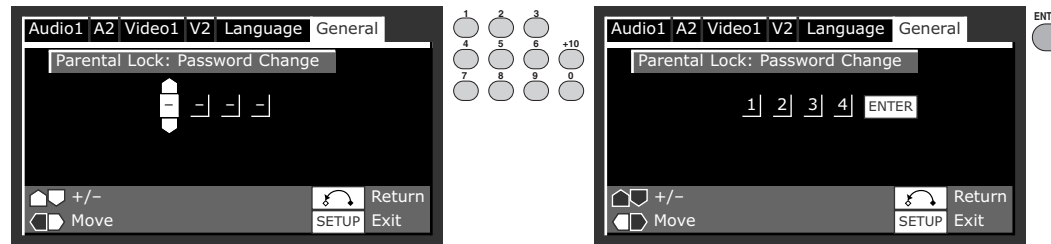
When a user-defined password is assigned, that password must be entered before the RT-10 will activate playback mode when a disc encoded with a user-defined security level is loaded. The user-defined password must also be entered before the Level and Country Code controls can be adjusted.

Note:

If the assigned password is lost or forgotten, factory-default settings must be restored to delete the password (5-16). Then, a new password can be entered.

1. When the Confirm Code Number screen opens, use the remote control number buttons to enter the assigned password.

- When a number is entered, the cursor automatically advances to the next character space. Press the ◀ arrow to return to the previous character space or the ▶ arrow to advance to the next character space.
 - The number entered in the selected character space appears as an actual number. Numbers entered in unselected character spaces appear as asterisks as shown above.
2. When the assigned password has been entered, an ENTER button appears on the on-screen display to indicate that pressing the remote control ENTER button will confirm the password.
 - If the assigned password has been entered, pressing the ENTER button closes the Confirm Code Number screen and opens the appropriate control screen.
 - If an incorrect password has been entered, pressing the ENTER button does not close the Confirm Code Number screen. Instead, the ENTER button grays and the cursor returns to the first character space.



To assign a new password:

When a user-defined password is assigned, that password must be entered before a new password can be assigned. When the current password is confirmed, the Parental Lock: Password Change screen opens on the on-screen display.

Note:

If the assigned password is lost or forgotten, factory-default settings must be restored to delete the password (5-16). Then, a new password can be entered.

1. When the Parental Lock: Password Change screen opens, use the remote control number buttons to enter the new password.
 - When a number is entered, the cursor automatically advances to the next character space. Press the ◀ arrow to return to the previous character space or the ▶ arrow to advance to the next character space.

2. When the new password has been entered, an ENTER button appears on the on-screen display to indicate that pressing the remote control ENTER button will assign the password.

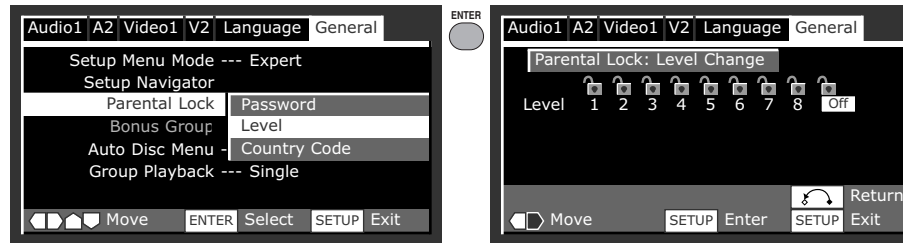
Level

1 to 8, off(country code)

Assigns a user-defined security level, requiring the password before the RT-10 will activate playback mode when a disc encoded with a user-defined security level is loaded. The Level control has no effect when a disc that is not encoded with a security level is loaded.

Select a number within the 1 to 8 range to assign a security level. The 1 setting represents the highest level of security, and the 8 setting represents the lowest level of security. When a security level is assigned, the RT-10 requires the user-defined password before activating playback mode when a disc encoded with a higher security level is loaded.

... General continues on page 3-46

General (continued from page 3-45)**Level** (continued)

Select off to use the Country Code control to determine security level. When off is selected, the RT-10 requires the user-defined password before activating playback mode when a disc encoded with an incompatible country code is loaded. The Country Code parameter has no effect on discs that are not encoded with a country code, regardless of the Level control setting.

To assign a security level:

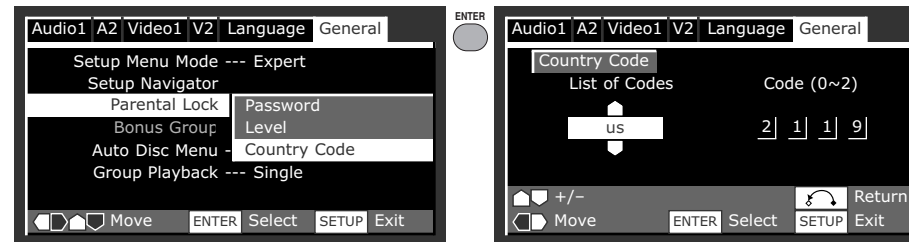
When the Level control is selected, the assigned password must be entered before a security level can be assigned. When the current password is confirmed, the Parental Lock: Level Change screen shown above opens on the on-screen display.

1. When the Parental Lock: Level Change screen opens, press the remote control ◀ and ▶ arrows to increase and decrease the assigned security level. The locks that appear on the on-screen display "lock" when the associated security level is selected and "unlock" when the associated security level is deselected.

2. When the desired security level has been selected, press the remote control ENTER button to assign that security level and close the Parental Lock: Level Change screen.
 - If the off(country code) setting is selected, make sure the desired country code is selected with the Country Code control. Otherwise, no security level will be assigned.

Note:

The remote control CONDITION MEMO button can be used to assign a specific security level for the loaded disc. Refer to page 4-10 for more information.



Country Code

Refer to the table on page A-16

Assigns a security level based on country code, requiring the password before the RT-10 will activate playback mode when a disc encoded with an incompatible country code is loaded. The Country Code control has no effect when the Level control is set within its 1 to 8 range or when a disc that is not encoded with a country code is loaded.

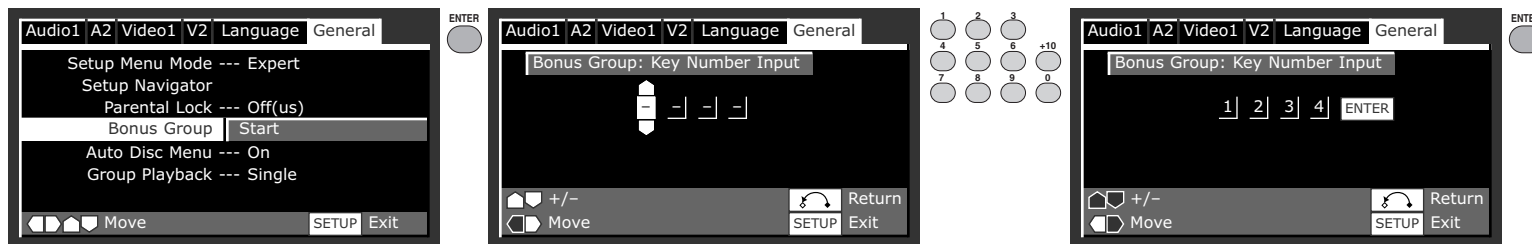
To assign a country code:

When the Country Code control is selected, the assigned password must be entered before a country code can be assigned. When the current password is confirmed, the Parental Lock: Country Code screen shown above opens on the on-screen display.

1. When the Parental Lock: Country Code screen opens, use one of the following methods to select the desired country code:
 - a. Press the remote control ▲ and ▼ arrows to scroll through the complete list of available countries. When the desired country is highlighted, press the remote control ENTER button to select that country and return to the General tab.

- b. Press the remote control ▶ arrow to move the cursor to the first character space that appears on the right of the on-screen display. Then, use the remote control number buttons to enter the numeric code for the desired country. Refer to the table on page A-16 to determine the appropriate numeric code. When the desired country is selected, press the remote control ENTER button to return to the General tab.

... General continues on page 3-48

General (continued from page 3-47)**Bonus Group**

Start

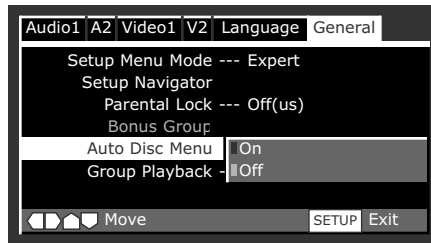
Opens the Bonus Group: Key Number Input screen shown above, which can be used to enter DVD-A bonus group access codes. In most cases, DVD-As include bonus groups that do not require an access code. Often, these bonus groups can be accessed from the disc menu. In other cases, DVD-As include bonus groups that cannot be accessed without a four-number access code, which is often located on the disc packaging. The Bonus Group parameter is not available for other disc formats or for DVD-As that include bonus groups that do not require an access code.

Note:

When playback of a DVD-A bonus group that requires an access code is attempted, the Bonus Group: Key Number Input screen automatically opens if the access code has not been entered since the disc was loaded, factory-default settings were restored, or the RT-10 was powered on.

To enter DVD-A bonus group access codes:

1. When the Bonus Group: Key Number Input screen opens, use the remote control number buttons to enter the bonus group access code.
 - When a number is entered, the cursor automatically advances to the next character space. Press the ◀ arrow to return to the previous character space or the ▶ arrow to advance to the next character space.
2. When the access code has been entered, an ENTER button appears on the on-screen display to indicate that pressing the remote control ENTER button will confirm the access code.



Auto Disc Menu

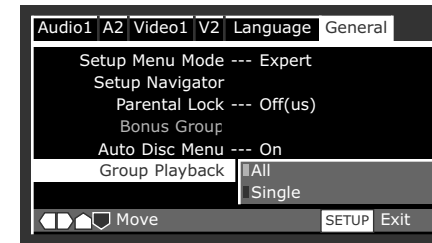
On, Off

Enables and disables automatic opening of DVD menus and top menus. This parameter has no effect on other disc formats or on DVDs that do not include menus or top menus.

When On is selected, DVD menus and top menus automatically open on the on-screen display when a DVD that includes menus or top menus is loaded. When Off is selected, DVD menus and top menus do not automatically open on the on-screen display when a DVD that includes menus or top menus is loaded. In either case, the remote control MENU and TOP MENU buttons can still be used to open and close disc menus and top menus. Refer to the Navigating Disc Menus section that begins on page 4-3 for more information.

Note:

Some DVDs include menus and top menus that automatically open on the on-screen display when the disc is loaded, regardless of the Auto Disc Menu parameter setting.



Group Playback

All, Single

Controls playback of DVD-A groups. This parameter has no effect on other disc formats or on DVD-As that include just one group of tracks.

DVD-As can include up to nine groups of tracks. Select All to automatically begin playback of the next group when playback of the selected group ends. Playback will continue until playback of the disc ends. Select Single to automatically activate stop mode when playback of the selected group ends. In some cases, the disc menu or top menu will open on the on-screen display when playback ends.

Note:

When the disc menu or top menu is used to select a group for playback, stop mode is automatically activated when playback of the selected group ends, regardless of the Group Playback parameter setting.

SETUP MENU SHORTCUTS

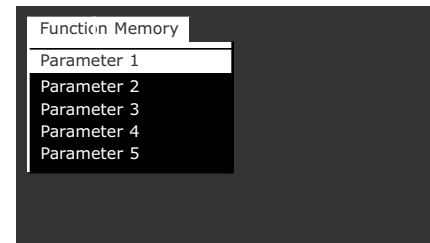
The remote control F.MEMO button can be used to create up to five shortcuts for Setup menu parameters. These shortcuts provide convenient access to frequently adjusted Setup menu parameters without navigating through the entire Setup menu.

Note:

Shortcuts cannot be created for the following Setup menu parameters: Linear PCM Out, SACD Playback, TV Screen, Audio Language, Subtitle Language, Auto Language, DVD Language, Subtitle Display, Subtitle Off, Setup Navigator, Parental Lock, Bonus Group, and Group Playback.

To create and delete Setup menu shortcuts:

- When the Setup menu is open, highlight the desired parameter for which to create or delete a shortcut.
 - Shortcuts can be created for up to five Setup menu parameters, excluding those listed in the Note: above.
 - Shortcuts can be deleted for Setup menu parameters for which a shortcut has been created. The icon shown at the right appears to the left of the parameter label when a shortcut has been created for that parameter.
- When the desired parameter is highlighted, press the remote control F.MEMO button.
 - If a shortcut can be created for the highlighted parameter the icon shown above will appear to the left of the parameter label.
 - If a shortcut has already been created for the highlighted parameter, the icon will shown above disappear from the left of the parameter label.

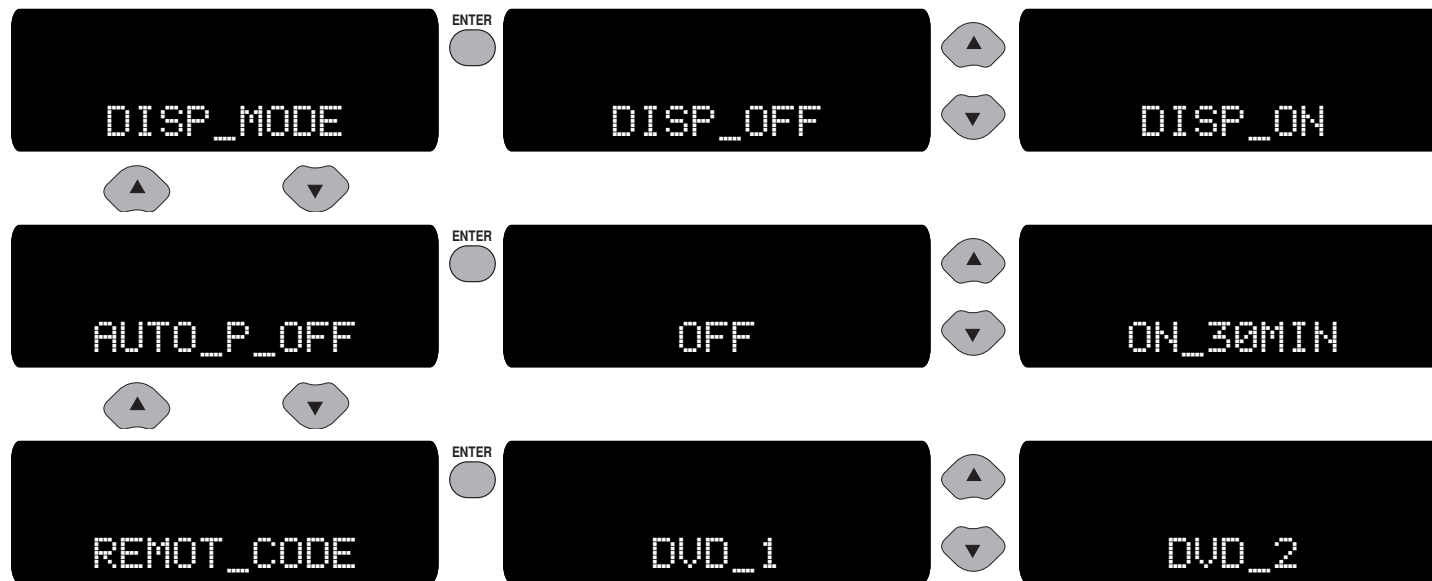


- If a shortcut cannot be created for the highlighted parameter, the icon shown at the right will appear on the on-screen display. Shortcuts cannot be created for the Setup menu parameters listed in the Note: in the previous column.



To use a Setup menu shortcut:

- If the Setup menu is closed, proceed to step 2. If the Setup menu is open, press the remote control SETUP button to close the Setup menu. Setup menu shortcuts cannot be used when the Setup menu is open.
- When the Setup menu is closed, press the remote control F.MEMO button to open the Function Memory tab shown above. The Function Memory tab lists all Setup menu parameters for which a shortcut has been created.
- When the Function Memory tab opens, press the remote control ▲ and ▼ arrows to highlight the desired shortcut. Then, press the remote control ENTER button to select that shortcut. The Setup menu will open on the on-screen display, highlighting the corresponding parameter.

ADVANCED SETUP MENU

The Advanced Setup menu can be used to configure advanced RT-10 mode settings for CD, SACD, and MP3 display mode, standby mode, and remote control command mode. Unlike the Setup menu, the Advanced Setup menu opens on the front panel display, which provides one-line viewing of parameters and settings as shown above.

Parameter	Default Setting	Possible Settings
DISP_MODE	DISP_OFF	<ul style="list-style-type: none"> DISP_OFF DISP_ON
AUTO_P	ON_30MIN	<ul style="list-style-type: none"> OFF ON_30MIN
REMOT_CODE	DVD_2	<ul style="list-style-type: none"> DVD_1 DVD_2

... Advanced Setup Menu continues on page 3-52

Advanced Setup Menu (continued from page 3-51)**To open the Advanced Setup menu:**

1. Press the Stop button to activate stop mode. In some cases, the Stop button must be pressed twice in succession to activate stop mode.
2. If the Setup menu is closed, proceed to step 3. If the Setup menu is open, press the remote control Setup button to close the Setup menu. The Advanced Setup menu is not available when the Setup menu is open.
3. When stop mode is activated and the Setup menu is closed, press and hold the SETUP button for about 2 seconds. The front panel Display Off button LED will begin blinking, indicating that the Advanced Setup menu is open on the front panel display.
 - When the Advanced Setup menu is open, the DISP_MODE parameter appears on the front panel display as shown on the previous page (first column, first row).

To navigate the Advanced Setup menu:

Button	Command
ENTER	Selects the highlighted parameter or setting.
▲ and ▼	Scroll upward and downward through parameters. When a parameter is selected, pressing the ▲ and ▼ arrows scrolls upward and downward through parameter settings.
SETUP	Closes the Advanced Setup menu.

DISP_MODE

DISP_ON, DISP_OFF

Determines the front panel display mode for SACD, CD, and MP3 playback. This parameter setting has no effect when other disc formats are loaded.

Select DISP_ON to deactivate the front panel display and rear panel video output connectors during SACD, CD, and MP3 playback. When SACD, CD, or MP3 playback is activated, press the front panel Display Off button or the remote control DIMMER button to activate the front panel display for 3 seconds. When stop mode is activated, the front panel display remains activated until playback resumes. The video output connectors remain deactivated until the DISP_MODE parameter is set to DISP_OFF.

Select DISP_OFF to activate the front panel display and rear panel video output connectors during SACD, CD, and MP3 playback. The front panel display and rear panel video output connectors will function as normal.

Note:

The DISP_MODE parameter might not function as described with some SACDs, CDs, or MP3s. If this occurs, set the DISP_MODE parameter to DISP_OFF so the front panel display and rear panel video output connectors will function as normal.

AUTO_P

ON_30MIN, OFF

Enables and disables automatic standby mode activation. When ON_30MIN is selected, the RT-10 automatically activates standby mode after 30 minutes of non-use. When OFF is selected, the RT-10 does not automatically activate standby mode after 30 minutes of non-use.

REMOT_CODE

DVD_1, DVD_2

Assigns a remote control command mode to the RT-10. When DVD_1 is selected, the RT-10 can be operated with an RT-10 remote control to which the DVD_1 command mode is also assigned. When DVD_2 is selected, the RT-10 can be operated with an RT-10 remote control to which the DVD_2 command mode is also assigned.

Assigning Remote Control Command Modes

The RT-10 remote control can be used to operate two RT-10s installed in the same system when the DVD_1 command mode is assigned to one RT-10 and the DVD_2 command mode is assigned to the other RT-10. These command modes can also be assigned to the remote control, allowing the remote control to operate an RT-10 to which the same command mode is assigned. The remote control cannot be used to operate an RT-10 to which a different command mode is assigned, except to configure Advanced Setup menu parameter settings.

Note:

The DVD_1 command mode is intended for use when two RT-10s are installed in the same system. Otherwise, avoid assigning the DVD_1 command mode to the RT-10 and the RT-10 remote control.

When one RT-10 is installed in the system, follow the instructions in the next column to assign the DVD_2 command mode to the remote control and the RT-10. The DVD_2 command mode is assigned to the RT-10 when factory-default settings are restored. The command mode assigned to the remote control is not affected when factory-default settings are restored.

When two RT-10s are installed in the same system, follow the instructions below to assign the DVD_1 command mode to one RT-10 and the DVD_2 command mode to the other RT-10. Follow the instructions below to toggle the command mode assigned to the remote control, allowing the remote control to provide independent operation of both RT-10s.

To assign the DVD_2 command mode to the remote control:

Press and hold the remote control STOP and number 2 buttons for about 5 seconds.

To assign the DVD_1 command mode to the remote control:

Press and hold the remote control STOP and number 1 buttons for about 5 seconds.

To confirm the command mode assigned to the remote control:

Press and hold the remote control STOP and PAUSE buttons for about 2 seconds. The command mode assigned to the remote control will appear on the front panel display.



To assign a command mode to the RT-10:

Follow the navigation instructions on the previous page to set the REMOT_CODE parameter to the desired command mode.

Playback Controls

Playback Icons	4-2
Loading Discs	4-2
Navigating Disc Menus	4-3
Selecting Disc Settings	4-7
<i>Audio Tracks • Subtitle Languages • Camera Angles • Storing Disc Settings</i>	
Playback Modes	4-11
<i>Playback • Last Memory Playback • Stop Mode • Resume Mode • Pause Mode • Still Frame Playback • Frame-by-Frame Playback • Slow Playback • Random Playback • Repeat Playback • A-B Repeat Playback • Program Mode • Search Mode • Display Mode</i>	

PLAYBACK ICONS

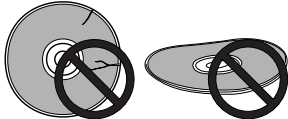
- The icon shown at the right appears on the on-screen display when the RT-10 does not allow the selected command. 
- The icon shown at the right appears on the on-screen display when the loaded disc does not allow the selected command. 

LOADING DISCS

Discs require special care and handling to ensure optimal performance. When loading discs, pay particular attention to the bulleted items that begin in the next column and to other precautions that appear throughout this user guide. Refer to the Disc Compatibility (1-5), Disc Care & Handling (1-8), and Disc Maintenance (5-16) sections for more information.

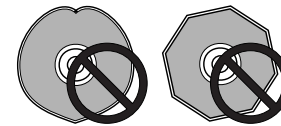
CAUTION The RT-10 is a single-disc player. Do not attempt to load more than one disc in the disc drawer at one time. This might cause damage to the RT-10, the discs, or both.

Dirty or damaged discs such as those shown below might affect playback performance or damage the RT-10. Do not attempt to load cracked, chipped, scratched, warped, dirty, or otherwise damaged discs in the disc drawer.

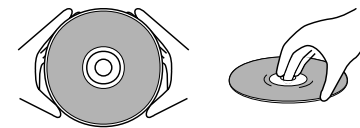


Note the following:

- The RT-10 is compatible with DVD-V, DVD-A, DVD-RW/R, SACD, Audio CD, CD-RW/R, Video CD, SVCD, and MP3 formats that meet the requirements outlined in the Disc Compatibility section (1-5). The RT-10 is not compatible with DVD-ROM, DVD-RAM, CD-ROM (except those that include MP3 tracks), and Photo CD formats.
- The RT-10 is compatible with 5-inch (12cm) and 3-inch (8cm) conventional, round discs. Do not attempt to load discs with other size and shape characteristics, such as those shown below. All discs must align with the circular guide inside the disc drawer.



- Hold discs at their center hole and outer edges as shown below. Take care not to leave fingerprints, dirt, or scratches on disc surfaces.



- Load single-sided discs with the label side facing upward and double-sided discs with the side intended for playback facing downward.
- Return discs to their cases when not in use. Discs should be stored in an upright position out of direct sunlight and excessive heat, humidity, or cold.

- The RT-10 will attempt to load a disc whenever the disc drawer is closed, even when the disc drawer is empty.

To load a disc:

1. Review the bulleted items that begin on the previous page.
2. Press the Open/Close button to open the disc drawer.
3. If the disc drawer is not empty, remove the disc loaded in the disc drawer (if applicable).
 - The RT-10 is a single-disc player. Do not attempt to load more than one disc in the disc drawer at one time. This might cause damage to the RT-10, the discs, or both.
4. When the disc drawer is empty, load the desired disc in the disc drawer.
 - Load single-sided discs with the label side facing upward and double-sided discs with the side intended for playback facing downward. All discs must align with the circular guide inside the disc drawer.
5. When the desired disc has been loaded, press the Open/Close button to close the disc drawer. The disc drawer can also be closed with a **gentle** press against the front of the disc drawer.

NAVIGATING DISC MENUS

Most discs include on-screen display menus that can be used to select disc settings, control playback, or view information about the disc. The descriptions that begin below provide a general overview of disc menus available for each disc format.

Note:

This descriptions that begin below provide a general overview of disc menus available for each disc format. These descriptions might differ for some discs within each format.

DVD-V

Include menus that can be used to activate playback of specific scenes and to select disc settings such as audio track (audio language and output format), subtitle language, and camera angle. In some cases, certain remote control buttons can also be used to select these settings without navigating through the disc menu (4-7).

DVD-A

Include top menus that can be used to activate playback of specific tracks and to select disc settings such as output format.

DVD-RW/R

Include an Original List screen that provides information about the contents of the disc as recorded. Some discs also include a Play List screen that provides information about the contents of the disc as programmed.

. . . Navigating Disc Menus continues on page 4-4

Navigating Disc Menus (continued from page 4-3)

SACD, Audio CD, & CD-RW/R

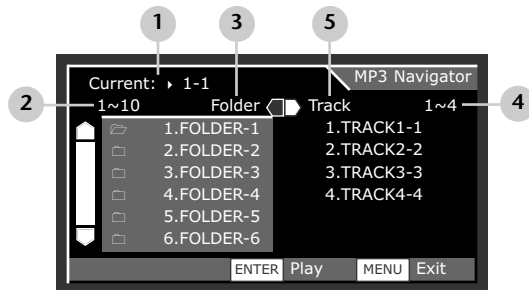
These disc formats do not include disc menus. In some cases, CD-RW/Rs that include MP3 tracks also include an MP3 Navigator (below and 4-27).

Video CD & SVCD

Include PBC (Playback Control) menus that can be used to activate playback of specific tracks. In some cases, the remote control number buttons can also be used to activate playback of specific tracks when the PBC menu is open.

MP3

Include an MP3 Navigator similar to the one shown below. The MP3 Navigator can be used to edit the MP3 program list, activate playback of specific folders and tracks, and view the MP3 file structure.



No.	Description
1	Indicates the numbers of the currently playing folder and track. The MP3 Navigator does not provide this information unless playback is activated.
2	Indicates the number of the selected folder and the number of folders included on the loaded disc. The RT-10 recognizes a maximum of 250 folders per disc. It ignores all folders that exceed this number.
3	Indicates the number and name assigned to each folder on the loaded disc.
4	Indicates the number of the selected track and the number of tracks included in the selected folder. The RT-10 recognizes a maximum of 250 tracks per folder. It ignores all folders that exceed this number.
5	Indicates the number and name assigned to each track in the selected folder.

To navigate disc menus:

The table on pages 4-5 and 4-6 provides a general overview of remote control commands that can be used to navigate disc menus. **In most cases, the remote control button must be pressed while the menu is open.** Otherwise, the button executes the command indicated in the Command Matrix that begins on page 2-15. In some cases, the command indicated in the Command Matrix can also be used when the menu is open.

Note the following:

- The table on pages 4-5 and 4-6 provides a general overview of remote control commands that can be used to navigate disc menus. Some commands might not be available for all discs within each format.

Disc Menu Command Matrix

Button	DVD-V & DVD-A	DVD-RW/R	Video CD & SVCD	MP3
MENU & TOP MENU	When a DVD-V is loaded, pressing the MENU button opens and closes the disc menu, provided the loaded disc includes a menu. In some cases, pressing the TOP MENU button also opens and closes the menu. When a DVD-A is loaded, pressing the TOP MENU button opens and closes the disc top menu, provided the loaded disc includes a top menu. The TOP MENU button must be pressed to open and close DVD-A top menus. Pressing the MENU button performs no function.	Pressing the MENU button opens and closes the disc menu, provided the loaded disc includes a menu. Pressing the TOP MENU button performs no function.	Perform no function.	Pressing the MENU button opens and closes the MP3 Navigator, provided the loaded disc includes an MP3 Navigator. Pressing the TOP MENU button performs no function.
Number Buttons	Select the corresponding menu item. When menu items are numbered, pressing a number button selects the menu item with the corresponding number. When menu items are not numbered, pressing a number button selects the menu item in the corresponding position. For instance, pressing the number 1 button selects the first menu item. Refer to page 2-15 for instructions to select menu items 10 and above.	Perform no function.	Same as DVD-V & DVD-A. In some cases, pressing a number button activates playback of corresponding track when the PBC menu is open.	Perform no function.
CLEAR	Performs no function.	Performs no function.	Performs no function.	Deletes the selected track from the MP3 program list (4-27).
PROGRAM	Performs no function.	Performs no function.	Performs no function.	Adds the selected track to the MP3 program list (4-27).
ENTER	Selects the highlighted disc menu item.	Same a DVD-V & DVD-A.	Performs no function.	Activates playback of the selected track or the first track in the selected folder.
RETURN	Closes the current disc menu screen and opens the previous menu screen. When the first menu screen is open, pressing the RETURN button performs no function. When a DVD-A is loaded, pressing the RETURN button opens the browsable pictures, provided the loaded disc includes browsable pictures.	Performs no function.	Opens and closes the PBC menu, provided the loaded disc includes a PBC menu.	Closes the MP3 Navigator.

. . . Disc Menu Command Matrix continues on page 4-6

Disc Menu Command Matrix (continued from page 4-5)

Button	DVD-V & DVD-A	DVD-RW/R	Video CD & SVCD	MP3
▲ & ▼	Scroll upward and downward through disc menu items. In some cases, pressing the ▲ and ▼ arrows scrolls left and right through menu items	Same as DVD-V & DVD-A.	Perform no function.	When the folder list is selected, pressing the ▲ and ▼ arrows scrolls upward and downward through the folder list. When the track list is selected, pressing the ▲ and ▼ arrows scrolls upward and downward through the track list.
◀ & ▶	Scroll left and right through disc menu items. In some cases, pressing the ◀ and ▶ arrows scrolls upward and downward through menu items.	Toggle between the Original List and Play List screens when all of the following conditions are met: <ul style="list-style-type: none"> • The loaded disc includes Original List and Play List screens. • Stop mode is activated. • No menu items are selected. When a menu item is selected, pressing the ◀ arrow activates playback at the first frame of the selected menu item. 	Perform no function.	Toggle between the folder and track lists.
PREV	Closes the current disc menu screen and opens the previous menu screen. When the first menu screen is open, pressing the PREV button performs no function.	Same as DVD-V & DVD-A.	Same as DVD-V & DVD-A.	Perform no function.
NEXT	Closes the current disc menu screen and opens the next menu screen. When the last menu screen is open, pressing the NEXT button performs no function.	Same as DVD-V & DVD-A.	Same as DVD-V & DVD-A.	Perform no function.
SEARCH, AUDIO, SUBTITLE, & ANGLE	When a DVD-V is loaded, pressing one of these buttons opens the corresponding menu screen, provided the loaded disc includes the corresponding menu screen. When a DVD-A is loaded, pressing one of these buttons performs no function.	Perform no function.	Perform no function.	Perform no function.

SELECTING DISC SETTINGS

Some disc menus can be used to select disc settings such as audio track (audio language and output format), subtitle language, and camera angle. In some cases, certain remote control buttons can also be used to select these settings without navigating through the disc menu.

Note:

Condition memory mode (4-10) stores audio language, output format, subtitle language, and camera angle settings for up to 15 DVD-Vs. Once stored, these settings will be automatically recalled whenever the disc is loaded.

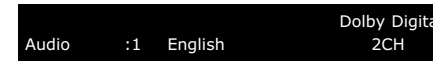
AUDIO TRACKS



- Pressing the remote control AUDIO button opens one of the Audio bars shown in the next column, which can be used to select the desired audio track (audio language and output format).
- Audio track selection is available for DVD-Vs, Video CDs, and MP3s recorded with two or more audio tracks. Audio track selection is not available for other disc formats or for discs recorded with one audio track. In addition, audio track selection is not available unless playback is activated.
- DVD-V and Video CD audio tracks include an audio language and output format. MP3 audio tracks include an output format.
- Audio track selection has no effect on the Audio Language parameter (3-37) setting.

To select an audio track:

1. When playback is activated, press the AUDIO button to open one of the Audio bars shown below.
 - When a DVD-V or Video CD is loaded, an Audio bar similar to the one shown below will open at the top of the on-screen display, indicating the audio language and output format in which the selected audio track was recorded. For instance, the Audio bar shown below indicates that the selected audio track was recorded in English in 2-channel Dolby Digital format.



- When an MP3 is loaded, one of the Audio bars shown below will open at the top of the on-screen display, indicating the output format in which the selected audio track was recorded – stereo, mono, or 2-channel.



- If the Audio bar does not open at the top of the on-screen display, audio track selection might not be available for the loaded disc.
2. When the Audio bar opens, press the AUDIO button again to cycle through all audio tracks available on the loaded disc. The remote control number buttons can also be used to enter the number of the desired audio track (if known).

... Audio Tracks continues on page 4-8

Audio Tracks (continued from page 4-7)

Subtitle :1 English

Note:

The Audio bar automatically closes a few seconds after the last command is received. If this occurs, playback will automatically activate using the selected audio track.

- When the desired audio track is selected, press the Play button or the remote control ENTER button to activate playback using the selected audio track.

SUBTITLE LANGUAGES

- Pressing the remote control SUBTITLE button opens the Subtitle bar shown at the top of the next column, which can be used to select the desired subtitle language.
- Subtitle language selection is available for DVD-Vs recorded with subtitles. Subtitle language selection is not available for other disc formats or for discs that are not recorded with subtitles. In addition, subtitle language selection is not available unless playback is activated.
- Subtitle language selection has no effect on the Subtitle Language parameter (3-38) setting.

To select a subtitle language:

- When playback is activated, press the SUBTITLE button to open the Subtitle bar shown above.
 - The Subtitle bar indicates the language in which the selected subtitles were recorded. For instance, the Subtitle bar shown above indicates that the selected subtitles were recorded in English.
 - If the Subtitle bar does not open at the top of the on-screen display, subtitle language selection might not be available for the loaded disc.
- When the Subtitle bar opens, press the SUBTITLE button again to cycle through all subtitle languages available on the loaded disc. The remote control number buttons can also be used to enter the number of the desired subtitle language (if known).
 - Select Subtitle Off to prevent subtitles from appearing on the on-screen display during playback.

Note:

The Subtitle bar automatically closes a few seconds after the last command is received. If this occurs, playback will automatically activate using the selected subtitle language.

- When the desired subtitle language is selected, press the Play button or the remote control ENTER button to activate playback using the selected subtitle language.

CAMERA ANGLES



- Pressing the remote control ANGLE button opens the Angle bar shown below, which can be used to select the desired camera angle.
- Camera angle selection is available for DVD-V scenes recorded from multiple camera angles. Camera angle selection is not available for other disc formats or for DVD-V scenes recorded from one camera angle. In addition, camera angle selection is not available unless playback is activated.
- The Angle Indicator parameter (3-35) activates and deactivates the indicator. When set to On, the indicator appears on the front panel display when playback of a scene recorded from multiple camera angles is in progress. When set to Off, the indicator does not appear on the front panel display when playback of a scene recorded from multiple camera angles is in progress.

To select a camera angle:

1. When playback is activated, press the ANGLE button to open the Angle bar shown below.
 - The Angle bar indicates the number of the selected camera angle and the number of camera angles from which the currently playing scene was recorded. For instance, the Angle bar shown below indicates that camera angle 1 of 2 is selected.

Angle :1/2

- If the Angle bar indicates that camera angle 1 of 1 is selected, the currently playing scene was recorded from one camera angle. In this case, camera angle selection is not available.
 - If the Angle bar does not open at the top of the on-screen display, camera angle selection might not be available for the loaded disc.
2. When the Angle bar opens, press the ANGLE button again to cycle through all camera angles available for the currently playing scene. The remote control number buttons can also be used to enter the number of the desired camera angle (if known).

Note:

The Angle bar automatically closes a few seconds after the last command is received. If this occurs, playback will automatically activate from the selected camera angle.

3. When the desired camera angle is selected, press the Play button or the remote control ENTER button to activate playback from the selected camera angle.

STORING DISC SETTINGS



- Pressing the remote control CONDITION MEMO button activates condition memory mode, which stores preferred disc settings for up to 15 DVD-Vs. Once stored, these settings will be automatically recalled whenever the disc is loaded.
- Preferred disc settings can be stored for DVD-Vs that allow the selection of on-screen display disc menu language, audio track (audio language and output format), subtitle language, camera angle, Video Adjust, or parental security level settings. Preferred disc settings cannot be stored for other disc formats or for DVD-Vs that do not allow at least one of these selections.
- Preferred disc settings cannot be stored for selections the loaded DVD-V does not allow. For instance, if the loaded DVD-V does not allow selection of an on-screen display disc menu language setting, a preferred on-screen display disc menu language setting cannot be stored. However, preferred disc settings can still be stored for other selections the loaded DVD-V allows.
- Preferred disc settings can be stored for up to 15 DVD-Vs. **The oldest set of preferred disc settings is automatically deleted when the sixteenth set of preferred disc settings is stored.** All preferred disc settings are automatically deleted when factory-default settings are restored.
- Most DVD-Vs include disc menus can be used to select disc settings. In some cases, certain remote control buttons can also be used to select disc settings without navigating through the disc menu. Refer to page 4-7 to 4-9 for more information.
- Disc menu settings do not affect Setup or Advanced Setup menu parameter settings.

To store preferred disc settings:

1. Make sure a DVD-V that allows selection of on-screen display disc menu language, audio track (audio language and output format), subtitle language, camera angle, Video Adjust, or parental security level settings is loaded.
2. Refer to the Navigating Disc Menus section (4-3) for instructions to select on-screen display disc menu language, audio track (audio language and output format), subtitle language, camera angle, Video Adjust, or parental security level settings.
 - In some cases, certain remote control buttons can also be used to select disc settings without navigating through the disc menu. Refer to pages 4-7 to 4-9 for more information.
3. When the desired disc settings have been selected, press the Play button to activate playback.
 - Pressing the Play button might not activate playback when the disc menu is open on the on-screen display. If this occurs, press the remote control MENU or TOP MENU button to close the disc menu. Then, press the Play button again to activate playback.
4. When playback is activated, press the CONDITION MEMO button. The Condition Memory bar shown below will open at the top of the on-screen display to indicate that preferred disc settings have been stored for the loaded disc. Once stored, these settings will be automatically recalled whenever the disc is loaded.

Condition Memory

To delete preferred disc settings:

1. Make sure a DVD-V for which preferred disc settings have been stored is loaded.
2. When the disc is loaded, press the Play button to activate playback.
3. When playback is activated, press the CONDITION MEMO button to open the Condition Memory bar shown on the previous page.
4. When the Condition Memory bar opens, press the remote control CLEAR button to delete preferred disc settings.

PLAYBACK MODES

The RT-10 offers a range of playback modes that can be used to control playback of the loaded disc. **The table on the next page indicates the playback modes available for each disc format.**

PLAYBACK

- The front panel or remote control Play button can be used to activate playback of the loaded disc at regular playback speed. In some cases, the remote control number buttons can also be used to activate playback of a specific title, chapter, group, or track.
- The Play button might not activate playback when the disc menu is open on the on-screen display.
- Some discs automatically activate regular playback when switching titles, chapters, groups, or tracks, even if a different playback mode (i.e. random playback) was activated before the switch.

- When playback is activated, the remote control ◀ and ▶ buttons might stop functioning. To restore functionality, press the Stop button to activate stop mode. In some cases, the Stop button must be pressed twice in succession to activate stop mode. Then, press the Play button to reactivate playback.
- The RT-10 might require a few seconds to activate playback of an MP3 track that is included in a complex MP3 file structure. When this occurs, the message "Please wait a moment" appears on the on-screen display.
- The RT-10 does not allow playback of incompatible MP3 tracks (1-7). When the MP3 Navigator is open and an incompatible MP3 track is selected, the icon shown at the right appears on the on-screen display. When the MP3 Navigator is closed and an incompatible MP3 track is selected, the message "UNPLAYABLE MP3 FORMAT" appears on the on-screen display.
- When playback of an MP3 track is activated, the name of the track appears on the front panel display for the first 5 seconds of playback.

**To activate playback:**

Press the Play button.

- In some cases, the remote control number buttons can also be used to activate playback of a specific title, chapter, group, or track.

Playback Modes (continued from page 4-11)

Playback Mode*	DVD-V & DVD-RW/R	DVD-A	SACD	Audio CD & CD-RW/R	Video CD	SVCD	MP3
Playback	Available	Available	Available	Available	Available	Available	Available
Last Memory	Available	Not Available	Not Available	Not Available	Available	Not Available	Not Available
Stop	Available	Available	Available	Available	Available	Available	Available
Resume	Available	Not Available	Not Available	Not Available	Available	Not Available	Not Available
Pause	Available	Available	Available	Available	Available	Available	Available
Still Frame	Available	Available†	Not Available	Not Available	Available	Available	Not Available
Frame-by-Frame	Available	Available†	Not Available	Not Available	Available	Available	Not Available
Slow	Available	Available†	Not Available	Not Available	Available	Available	Not Available
Random	Title, Chapter	Group, Track	Not Available	Track	Available**	Available**	Track
Repeat	Title, Chapter, Program	Group, Track, Program	Track, All, Program	Track, Disc, Program	Available**	Available**	Track, Folder, Disc, Program
A-B Repeat	Available	Available†	Not Available	Available	Available**	Available**	Not Available
Program	Title, Chapter	Group, Track	Track	Track	Track	Track	Track
Search	Title, Chapter, Time, Time + Frame	Group, Track, Page††	Track	Track	Track	Track	Track, Folder
Display	Available	Available	Available	Available	Available	Available	Available

* This table provides a general overview of the playback modes available for each disc format. However, these modes might not be available for all discs within each format.

† These modes are available for DVD-As that include video.

** These modes are not available for Video CDs and SVCDs that include PBC menus.

†† These modes are available for DVD-As that include browsable pictures.

LAST MEMORY PLAYBACK

LAST MEMO 

- The remote control LAST MEMO button can be used to activate last memory playback, which creates a bookmark at the current playback time. Later, playback can be reactivated from the bookmarked playback time.
- Bookmarks can be stored for up to five discs. **The oldest bookmark is automatically deleted when the sixth bookmark is stored.**
- Video CD bookmarks are automatically deleted when the disc drawer is opened or the RT-10 is powered off with the front panel On/Off button. All bookmarks are automatically deleted when factory-default settings are restored.

To create a bookmark at the current playback time:

When playback is activated, press the LAST MEMO button. The Last Memory bar shown below will open at the top of the on-screen display to indicate that a bookmark has been created at the current playback time.

- When the LAST MEMO button is pressed and held, the Condition Memory bar shown on page 4-10 will open at the top of the on-screen display. If this occurs, press the remote control CONDITION MEMO button to close the Condition Memory bar.

Last Memory 

To activate playback from a bookmarked playback time:

1. Make sure a disc for which a bookmark has been created is loaded.
 - If playback automatically activates, press the Stop button to activate stop mode. In some cases, the Stop button must be pressed twice in succession to activate stop mode.
 - If the disc menu automatically opens on the on-screen display, press the remote control MENU or TOP MENU button to close the disc menu.
2. When the disc is loaded, press the LAST MEMO button to activate playback from the bookmarked playback time. The Last Memory bar shown at the bottom of the previous column will open at the top of the on-screen display to indicate that last memory playback is activated.

To delete a bookmark:

1. Make sure a disc for which a bookmark has been created is loaded.
2. When the disc is loaded, press the Play button to activate playback.
3. When playback is activated, press the LAST MEMO button to open the Last Memory bar shown at the bottom of the previous column.
 - If no bookmark has been created for the loaded disc, performing this step will create a bookmark at the current playback time. If this occurs, begin again with step 1.
4. When the Last Memory bar opens, press the LAST MEMO button again to delete the bookmark.

STOP MODE



- The front panel and remote control Stop button can be used to activate stop mode, which stops playback of the loaded disc. In some cases, the Stop button must be pressed twice in succession to activate stop mode.
- When an MP3 is loaded, activating stop mode does not deselect the selected folder unless random playback or program mode is activated.
- Audio automatically mutes when stop mode is activated.

To activate stop mode:

When playback is activated, press the Stop button. In some cases, the Stop button must be pressed twice in succession to activate stop mode. When stop mode is activated, playback cannot be reactivated at the current playback time.

RESUME MODE



- The front panel and remote control Stop button can be used to activate resume mode, which pauses playback at the current playback time. Later, playback can be reactivated from this playback time.
- Audio automatically mutes when resume mode is activated.

To activate resume mode:

When playback is activated, press the Stop button. The Resume bar shown below will open at the top of the on-screen display to indicate that resume mode is activated.

- If the Resume bar does not appear on the on-screen display, resume mode might not be available for the loaded disc. The table on page 4-12 indicates the playback modes available for each disc format.



To deactivate resume mode:

- Press the Play button to reactivate playback at the current playback time.
- Press the Stop button to activate stop mode. When stop mode is activated, playback cannot be reactivated at the current playback time.

PAUSE MODE



- The front panel and remote control Pause button can be used to activate pause mode, which pauses playback at the current playback time. In some cases, activating pause mode creates a still frame image on the associated display device screen. Refer to the still frame playback description below for more information.
- Audio automatically mutes when pause mode is activated.

To activate pause mode:

When playback is activated, press the Pause button.

To deactivate pause mode:

- Press the Play or Pause button to reactivate playback at the current playback time.
- Press the Stop button to activate stop or resume mode. In some cases, the Stop button must be pressed twice in succession to activate stop mode. When stop mode is activated, playback cannot be reactivated at the current playback time.

STILL FRAME PLAYBACK



- The front panel and remote control Pause button can be used to activate still frame playback, which pauses playback at the current playback time and creates a still frame image on the associated display device screen.

- The Still Picture parameter (3-35) controls the appearance of still frame images. When set to Field, the RT-10 produces tight, stable, and generally shake-free still frame images. When set to Frame, the RT-10 produces sharper, but shakier still frame images. When set to Auto, the RT-10 automatically selects the best viewing method for still frame images.
- **Still frame images displayed on CRT display devices for long periods of time can "burn in" or create "ghost images" on the display device screen. When the RT-10 is connected to a CRT display device, it is recommended to set the Screen Saver parameter (3-28) to On to prevent the appearance of "ghost images" on the display device screen.**
- Audio automatically mutes when still frame playback is activated.

To activate still frame playback:

When playback is activated, press the Pause button.

- If a still frame image does not appear on the display device screen, still frame playback might not be available for the loaded disc. The table on page 4-12 indicates the playback modes available for each disc format.

To deactivate still frame playback:

- Press the Play or Pause button to reactivate playback at the current playback time.
- Press the Stop button to activate stop or resume mode. In some cases, the Stop button must be pressed twice in succession to activate stop mode. When stop mode is activated, playback cannot be reactivated at the current playback time.

FRAME-BY-FRAME PLAYBACK

- The remote control Pause, ◀◀, and ▶▶ buttons can be used to activate frame-by-frame playback, which plays the loaded disc one frame at a time in the selected direction.
- Video CDs are not compatible with reverse frame-by-frame playback.
- Audio automatically mutes when frame-by-frame playback is activated.

To activate frame-by-frame playback:

1. When playback is activated, press the Pause button to pause playback at the current playback time.
2. When pause mode is activated, press and release the ◀◀ or ▶▶ button to activate reverse or forward frame-by-frame playback. The picture on the associated display device screen will rewind or advance one frame in the selected direction.
 - Video CDs are not compatible with reverse frame-by-frame playback.
3. Continue pressing and releasing the ◀◀ or ▶▶ button to continue frame-by-frame playback in the selected direction.

To deactivate frame-by-frame playback:

- Press the Play button to activate playback at the current playback time.
- Press the Stop button to activate stop or resume mode. In some cases, the Stop button must be pressed twice in succession to activate stop mode. When stop mode is activated, playback cannot be reactivated at the current playback time.

SLOW PLAYBACK

- The remote control Pause, ◀◀, and ▶▶ buttons can be used to activate slow playback, which plays the loaded disc at 1/16, 1/8, 1/4, or 1/2 regular playback speed in the selected direction.
- Video CDs are not compatible with reverse slow playback.
- Audio automatically mutes when slow playback is activated.

To activate slow playback:

1. When playback is activated, press the Pause button to pause playback at the current playback time.
2. When pause mode is activated, press and hold the ◀◀ or ▶▶ button for about 1 second to activate reverse or forward slow playback at 1/16 regular playback speed.
 - Video CDs are not compatible with reverse slow playback.
3. Press and release the ◀◀ or ▶▶ button again to cycle through all available slow playback speeds – 1/16, 1/8, 1/4, or 1/2 regular playback speed.

To deactivate slow playback:

- Press the Play button to activate playback at the current playback time.
- Press the Stop button to activate stop or resume mode. In some cases, the Stop button must be pressed twice in succession to activate stop mode. When stop mode is activated, playback cannot be reactivated at the current playback time.

- Press the Pause button or the opposite skip/scan button (i.e. the ◀ button if forward slow playback is activated) to pause playback at the current disc location.

RANDOM PLAYBACK



- The remote control RANDOM button can be used to activate random playback, which plays the loaded disc in a random order of titles, chapters, groups, or tracks. The table on page 4-12 indicates the random playback modes available for each disc format.
- Random playback is not available for Video CDs and SVCDs that include PBC menus.
- Random playback is automatically deactivated when:
 - repeat playback or program mode is activated
 - the remote control CLEAR, STOP, REPEAT, or PROGRAM button is pressed

Random Playback Modes

Title

Activates playback of the loaded disc in a random order of titles, beginning with the currently playing title. When the loaded disc includes just one title, activating random title playback repeats playback of that title.

Chapter

Activates playback of the loaded disc in a random order of chapters, beginning with the currently playing chapter. Random chapter playback includes chapters in the currently playing title. It does not include chapters in other titles. When the currently playing title includes just one chapter, activating random chapter playback repeats playback of that chapter.

Group

Activates playback of the loaded disc in a random order of groups, beginning with the currently playing group. When the loaded disc includes just one group, activating random group playback repeats playback of that group.

Track

Activates playback of the loaded disc in a random order of tracks, beginning with the currently playing track. When a DVD-A is loaded, random track playback includes tracks in the currently playing group. When the currently playing group includes just one track, activating random track playback repeats playback of that track. When another disc format is loaded, random track playback includes all tracks on the loaded disc. When the loaded disc includes just one track, activating random track playback repeats playback of that track.

Note:

Random playback is not available for Video CDs and SVCDs that include PBC menus.

. . . *Random Playback continues on page 4-18*

Random Playback (continued from page 4-17)**To activate random playback:**

1. When playback is activated, press the remote control RANDOM button.
 - If a DVD is loaded, one of the Random bars shown above will open at the top of the on-screen display. The Random bar indicates the selected random playback mode. Proceed to step 2.
 - If another disc format is loaded, random track playback will automatically activate, beginning with the currently playing track. The instructions end here.
 - If the Random bar does not open at the top of the on-screen display, random playback might not be available for the loaded disc. The table on page 4-12 indicates the random playback modes available for each disc format.
2. When the Random bar opens, press the RANDOM button again the cycle through all random playback modes available for the loaded disc.
3. When the desired random playback mode is selected, press the Play button or the remote control ENTER button to activate the selected random playback mode.
 - Select Random Off to deactivate random playback.

4. When random playback is in progress:

- Press the remote control PREV button to return to the beginning of the currently playing title, chapter, group, or track.
- Press the remote control NEXT button to skip to the beginning of the next randomly selected title, chapter, group, or track. For instance, when random chapter playback is activated, pressing the NEXT button skips to the beginning of the next randomly selected chapter.

To deactivate random playback:

- Press the remote control CLEAR button to activate playback from the current playback time. The Random Off bar shown above (right) will open at the top of the on-screen display to indicate that random playback has been deactivated.
- Press the Stop button to activate stop or resume mode. In some cases, the Stop button must be pressed twice in succession to activate stop mode. When stop mode is activated, playback cannot be reactivated at the current playback time.

REPEAT PLAYBACK



- The remote control REPEAT button can be used to activate repeat playback, which repeats playback of the currently playing title, chapter, group, track, folder, or program list. The table on page 4-12 indicates the repeat playback modes available for each disc format.
- Repeat playback is not available for Video CDs and SVCDs that include PBC menus.
- Repeat playback is automatically deactivated when:
 - random playback or A-B repeat playback is activated
 - the remote control CLEAR, STOP, PREV, NEXT, RANDOM, or A-B button is pressed

Repeat Playback Modes

Title

Activates repeat playback of the currently playing title.

Chapter

Activates repeat playback of the currently playing chapter.

Group

Activates repeat playback of the currently playing group.

Track

Activates repeat playback of the currently playing track.

Folder

Activates repeat playback of the currently playing folder.

All or Disc

Activates repeat playback of the loaded disc.

Program

Activates repeat playback of the currently playing program list. Repeat program playback is not available unless program playback is activated when the REPEAT button is pressed.

Note:

Repeat playback is not available for Video CDs and SVCDs that include PBC menus.

To activate repeat playback:

1. Make sure playback of the desired title, chapter, group, track, folder, disc, or program list is activated.
 - Repeat program playback is not available unless program playback is activated when the REPEAT button is pressed.

... Repeat Playback continues on page 4-20

Repeat Playback (continued from page 4-19)



2. When playback is activated, press the REPEAT button to open one of the Repeat bars shown above will open at the top of the on-screen display.
 - The Repeat bar indicates the selected repeat playback mode.
 - If the Repeat bar does not open at the top of the on-screen display, repeat playback might not be available for the loaded disc. The table on page 4-12 indicates the repeat playback modes available for each disc format.
3. When the Repeat bar opens, press the REPEAT button again to cycle through all repeat playback modes available for the loaded disc.
 - If program playback was activated when the REPEAT button was pressed, repeat program playback is available. Other repeat playback modes are not available.

Note:

The Repeat bar automatically closes a few seconds after the last command is received. When this occurs, the selected repeat playback mode is automatically activated.

4. When the desired repeat playback mode is selected, press the Play button or the remote control ENTER button to activate the selected repeat playback mode.
 - Select Repeat Off to deactivate repeat playback. (This option is only available if program playback was activated when the REPEAT button was pressed.)

To deactivate repeat playback:

- Press the remote control CLEAR button to activate playback from the current playback time. The Repeat Off bar shown above (right) will open at the top of the on-screen display to indicate that repeat playback has been deactivated.
- Press the Stop button to activate stop or resume mode. In some cases, the Stop button must be pressed twice in succession to activate stop mode. When stop mode is activated, playback cannot be reactivated at the current playback time.

A-B REPEAT PLAYBACK



- The remote control A-B button can be used to activate A-B repeat playback from a user-defined start time (point A) to a user-defined end time (point B). A-B repeat playback can be configured to repeat playback of the user-defined playback loop once or continuously.
- A-B repeat playback is not available for Video CDs and SVCDs that include PBC menus.
- A-B repeat playback is automatically deactivated when:
 - random or repeat playback is activated
 - the remote control CLEAR, STOP, PREV, NEXT, RANDOM, or REPEAT button is pressed

To activate A-B repeat playback:

1. When playback is activated, press the A-B button at the desired start time (point A). The Memory bar shown below (left) will open at the top of the on-screen display to indicate that a start time has been selected.
 - To repeat the user-defined playback loop once, proceed to step 2.
 - To repeat the user-defined playback loop continuously, proceed to step 3.

2. Press the Play button at the desired end time (point B). The Repeat Memory bar shown below (center) will open at the top of the on-screen display to indicate that an end time (point B) has been selected. When the Repeat Memory bar opens, A-B repeat playback is automatically activated. When the user-defined end time (point B) is reached, regular playback is automatically activated at that time. Proceed to step 4.
3. Press the A-B button again at the desired end time (point B). The Repeat A-B bar shown below (right) will open at the top of the on-screen display to indicate that an end time (point B) has been selected. When the Repeat A-B bar opens, A-B repeat playback is automatically activated. Repeat playback of the user-defined playback loop continues until A-B repeat playback is deactivated. The instructions end here.
4. To redefine the end time (point B), press the A-B button again at the desired end time. The Repeat A-B bar shown below (right) will open at the top of the on-screen display to indicate that a new end time (point B) has been selected. When the Repeat A-B bar opens, A-B repeat playback is automatically reactivated, beginning with the start time (point A) selected in step 1 and continuing until the end time selected in this step is reached.

... A-B Repeat Playback continues on page 4-22

Memory

Search
Time

14.52 Repeat
Memory

Search
Time

14.52 Repeat
A-B

A-B Repeat Playback (continued from page 4-21)

To deactivate A-B repeat playback:

- Press the A-B button or the remote control CLEAR button to activate playback at the current playback time. In some cases, the A-B button must be pressed twice in succession to deactivate A-B repeat playback. The Repeat Off bar shown on page 4-20 will open at the top of the on-screen display to indicate that A-B repeat playback has been deactivated.
- Press the Stop button to activate stop or resume mode. In some cases, the Stop button must be pressed twice in succession to activate stop mode. When stop mode is activated, playback cannot be reactivated at the current playback time.

PROGRAM MODE



- The remote control PROGRAM button can be used to activate program mode, which creates a program list for the loaded disc. When a program list has been created, program mode also activates program playback. The table on page 4-12 indicates the program playback modes available for each disc format.
- A program list is a user-defined playback order of titles, chapters, groups, or tracks. The table on the next page indicates the program lists available for each disc format.
- When playback of a program chapter or program track list is activated, playback of a non-programmed chapter or track might activate while the RT-10 searches for the next programmed chapter or track.

To navigate Program tabs:

Button	Command
Number Buttons	Insert the corresponding value in the selected field. Refer to page 2-15 for instructions to enter values 10 and above.

Note the following:

- Program lists cannot contain values 100 and above or values that are not included on the loaded disc. For instance, a program title list cannot include a value of 5 if the loaded disc does not include title 5.
- When a new value is inserted, no previously inserted values are replaced or deleted. The new value is inserted in the selected field, moving all previously inserted values in and to the right of the selected field one field to the right. All previously inserted values to the left of the selected field are not affected.
- The program list must include at least one blank field before a new value can be inserted.

CLEAR	Deletes the value in the selected field, moving all previously inserted values to the right of the selected field one field to the left. For instance, the value to the immediate right of the selected field moves to the selected field. A blank field is inserted at the end of the program list.
▲ & ▼	Scroll upward and downward through Program tab items.
◀ & ▶	Scroll to the previous and the next field. The cursor will not scroll to blank fields.
Pause	Inserts a pause in the selected field. Pauses must be inserted between two values. In other words, pauses cannot be inserted in the first and last fields.

Program List Requirements

Disc Format(s)	Program Lists	Requirements	Storage
DVD-V & DVD-RW/R	One program title list per disc One program chapter list per title	Program lists cannot: <ul style="list-style-type: none"> include more than 24 entries, including titles, chapters, and pauses include values 100 and above include values that are not included on the loaded disc include chapters from different titles 	<ul style="list-style-type: none"> Program lists can be stored for up to 24 discs. The Program Memory parameter (4-24) determines program list storage. Program lists are automatically deleted when factory-default settings are restored.
DVD-A	One program group list per disc One program track list per group	Program lists cannot: <ul style="list-style-type: none"> include more than 24 entries, including groups, tracks, and pauses include values 100 and above include values that are not included on the loaded disc include tracks from different groups 	Program lists are automatically deleted when: <ul style="list-style-type: none"> the disc drawer is opened standby mode is activated the RT-10 is powered off with the front panel On/Off button factory-default settings are restored
SACD, Audio CD, & CD-RW/R	One program track list per disc	Program lists cannot: <ul style="list-style-type: none"> include more than 24 entries, including tracks and pauses include values 100 and above include values that are not included on the loaded disc 	Program lists are automatically deleted when: <ul style="list-style-type: none"> the disc drawer is opened standby mode is activated the RT-10 is powered off with the front panel On/Off button factory-default settings are restored
Video CD & SVCD	One program track list per disc	Program lists cannot: <ul style="list-style-type: none"> be created when playback or pause mode is activated include more than 24 entries, including tracks and pauses include values 100 and above include values that are not included on the loaded disc 	Program lists are automatically deleted when: <ul style="list-style-type: none"> the disc drawer is opened standby mode is activated the RT-10 is powered off with the front panel On/Off button factory-default settings are restored
MP3	One program track list per disc, which can be created with the MP3 Program tab (4-25) or the MP3 Navigator (4-27)	Program lists cannot: <ul style="list-style-type: none"> be created when playback or pause mode is activated include more than 24 entries, including tracks and pauses include values 100 and above include values that are not included on the loaded disc 	Program lists are automatically deleted when: <ul style="list-style-type: none"> the disc drawer is opened standby mode is activated the RT-10 is powered off with the front panel On/Off button factory-default settings are restored

... Program Mode continues on page 4-24

Program Mode (continued from page 4-23)**To create a program list:****Note:**

These instructions can be used to create MP3 program lists with the MP3 Program tab. Refer to page 4-27 for instructions to create MP3 program lists with the MP3 Navigator.

1. When a disc is loaded, press the remote control PROGRAM button to open one of the Program tabs shown at the top of the next page. The Program tab that was last modified will open on the on-screen display.
 - If a Video CD or SVCD is loaded, stop mode must be activated before the PROGRAM button is pressed.
 - If this is a DVD program list, proceed to step 2.
 - If this is not a DVD program list, proceed to step 6.
2. When a Program tab opens, press the remote control ◀ and ▶ arrows to select the desired Program tab.
 - If this is a DVD-V or DVD-RW/R program list, proceed to step 3.
 - If this is a DVD-A program group list, proceed to step 5.
 - If this is a DVD-A program track list, proceed to step 6.

Note the following:

- Program tabs automatically close a few seconds after the last command is received. If this occurs, all program list modifications that have not been previously stored will be deleted.
 - If the Program tab automatically closes when the Program Memory parameter is set to Off, all program list modifications that have not been previously stored will be deleted. It is recommended to set the Program Memory parameter to On to ensure that all program list modifications will be stored.
3. When the desired Program tab is selected, press the ▲ and ▼ arrows to select the Program Memory parameter at the bottom of the Program tab.

Program Memory

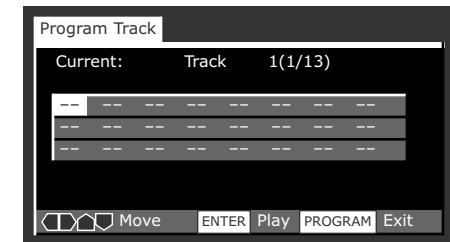
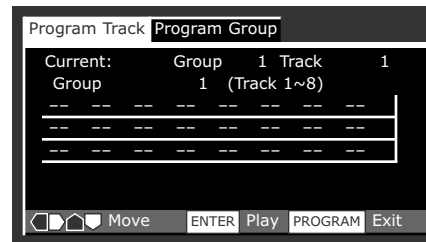
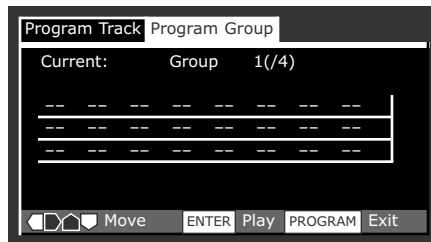
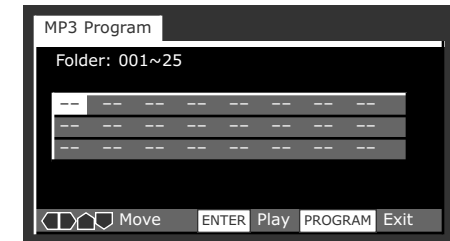
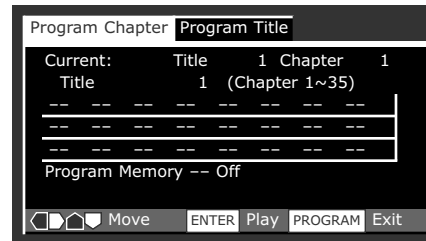
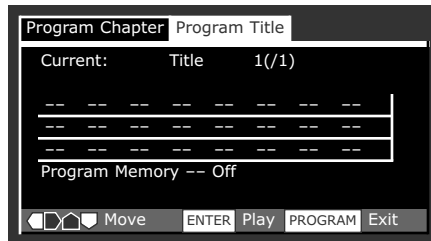
On, Off

Determines DVD-V and DVD-RW/R program list storage. This parameter is not available for other disc formats.

When On is selected, program lists for the loaded disc are stored until factory-default settings are restored. When Off is selected, program lists for the loaded disc are automatically deleted when the disc drawer is opened, standby mode is activated, the RT-10 is powered off, or factory-default settings are restored.

The Program Memory parameter setting applies to all program lists that have been created for the loaded disc. In other words, the Program Memory parameter cannot be set to On for a program title list and to Off for a program chapter list.

Program Tabs



- When the Program Memory parameter is selected, press the ◀ and ▶ arrows to move the cursor to the parameter settings menu that appears to the right of the parameter label. Then, press the ▲ and ▼ arrows to highlight the desired setting. When the desired setting is highlighted, press the remote control ENTER button to select this setting.

When the desired setting has been selected:

- If this is a program title list, proceed to step 5.
- If this is a program chapter list, proceed to step 6.

- Press the ▲ and ▼ arrows to select the Title or Group field at the top of the Program tab. Then, press the remote control number buttons to enter the corresponding title or group number for which the program chapter or program track list is being created. Program chapter or track lists cannot include chapters or tracks from different titles or groups.

- Press the ▲ and ▼ arrows to select the first field of the program list. Then, refer to the table on page 4-22 for instructions to insert the desired values.

... Program Mode continues on page 4-26

Program Mode (continued from page 4-25)

7. When the desired values have been entered, press the Play or ENTER button to close the Program tab and activate program playback.
 - Press the PROGRAM button to close the Program tab without activating program playback.
 - Refer to the Repeat Playback section that begins on page 4-20 to activate repeat program playback.

To add the currently playing title, chapter, group, or track to an existing program list:

1. Activate playback of a disc for which a program list has been created.
2. When playback of the desired title, chapter, group, or track is activated, press the remote control PROGRAM button for about 1 second.
 - If this is a DVD program list, refer to the notes that begin below.
 - If this is an SACD, CD, or SVCD program list, the currently playing track will be added to the end of the program track list. If no program track list has been created for the loaded disc, a new program track list will be created beginning with the currently playing track.

Note the following:

- The currently playing chapter will be added to the end of the program chapter list when a program chapter list has been created for the currently playing title. Likewise, the currently playing track will be added to the end of the program track list when a program track list has been created for the currently playing group.

- The currently playing title will be added to the end of the program title list when a program title list has been created for the loaded disc and a program chapter list has not been created for the currently playing title. Likewise, the currently playing group will be added to the end of the program group list when a program group list has been created for the loaded disc and a program track list has not been created for the currently playing group.
- When no program lists have been created for the loaded disc:
 - If the last program list modified was a program title or group list, a program title or group list will be created, beginning with the currently playing title or group.
 - If the last program list modified was a program chapter or track list, a program chapter or track list will be created, beginning with the currently playing chapter or track.

To delete a non-stored program list:

Note:

This procedure cannot be used to delete DVD-V and DVD-RW/R program lists that have been previously stored. Refer to the next page for instructions to delete DVD-V and DVD-RW/R program lists that have been previously stored.

1. Load a disc for which a program list has been created.
2. Press the Stop button to activate stop mode. In some cases, the Stop button must be pressed twice in succession to activate stop mode.
3. When stop mode is activated, press the remote control CLEAR button to delete the oldest non-stored program list.

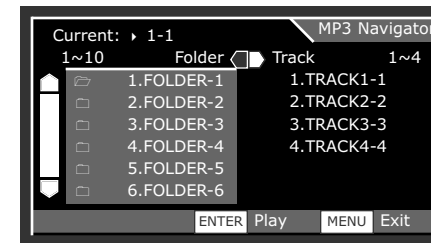
To delete stored DVD-V and DVD-RW/R program lists:

1. Load a DVD-V or DVD-RW/R for which a program list has been created.
2. When the desired disc is loaded, press the remote control PROGRAM button to open one of the Program tabs shown on page 4-25.
3. When a Program tab opens, press the remote control ◀ and ▶ arrows to select the desired Program tab.
4. When the desired Program tab is selected, press the ▲ and ▼ arrows to select the Program Memory parameter (4-24) at the bottom of the Program tab.
5. When the Program Memory parameter is selected, press the ◀ and ▶ arrows to move the cursor to the parameter settings menu that appears to the right of the parameter label. Then, press the ▲ and ▼ arrows to highlight the Off setting. When the Off setting is highlighted, press the remote control ENTER button to select this setting.

All program lists that have been created for the loaded disc will be automatically deleted when the disc drawer is opened, standby mode is activated, the RT-10 is powered off, or factory-default settings are restored.

To create an MP3 program list with the MP3 Navigator:

1. Load a CD-RW/R that includes MP3 tracks.
2. When the desired disc is loaded, press the remote control MENU button to open an MP3 Navigator similar to the one shown at the top of the next column.



3. When the MP3 Navigator opens, press the remote control ◀ and ▶ arrows to select the folder list on the left side of the MP3 Navigator.
4. When the folder list is selected, press the ▲ and ▼ arrows to select the desired folder for which to create a program list.
5. When the desired folder is selected, press the ▶ arrow to select the track list on the right side of the MP3 Navigator.
6. When the track list is selected, press the ▲ and ▼ arrows to select the desired track to include on the program list.
7. When the desired track is selected, press the remote control PROGRAM button to add the selected track to the program list. The icon shown at the right will appear to the left of the track name to indicate that the track has been added to the MP3 program list. If no program list has been created for the loaded disc, a new program list will be created beginning with the selected track.
 - To delete a track from the MP3 program list, press the remote control CLEAR button. The icon shown above will disappear from the left of the track name.



... Program Mode continues on page 4-28

Program Mode (continued from page 4-27)

8. Repeat steps 6 and 7 until all desired tracks have been added to the program list.
9. When all desired tracks have been added to the program list, press the MENU button to close the MP3 Navigator.
 - To activate program playback, press the PROGRAM button to open the program list. Then, press the Play button or the remote control ENTER button to activate program playback.

SEARCH MODE

- The remote control SEARCH button can be used to activate search mode, which activates playback of a specific title, chapter, group, track, folder, times, frame, or page on the loaded disc. The table on page 4-12 indicates the search modes available for each disc format.
- Most search modes are available whether playback, stop, resume, or pause mode is activated. However, the Time and Frame + Time search modes are not available unless playback or pause mode is activated.

Search Modes**Title**

Activates playback of the first chapter in the selected title.

Chapter

Activates playback of the selected chapter in the currently playing title.

Group

Activates playback of the first track in the selected group.

Track

- When a DVD-A is loaded, track search mode activates playback of the selected track in the currently playing group.
- When an MP3 is loaded, track search mode activates playback of the selected track in the currently playing folder.
- When another disc format is loaded, track search mode activates playback of the selected track

Folder

Activates playback of the first track in the selected folder.

Time

Activates playback at the selected playback time (minutes: seconds) in the currently playing title, chapter, group, track, or folder. This search mode is not available unless playback or pause mode is activated.

Title : 1

Track : 1

Time : 0.00

Chapter : 1

Page : 1

Time + Frame : 0.00 00

Group : 1

Frame + Time

Activates playback at the selected playback time (minutes:seconds) in the currently playing frame. This search mode is not available unless playback or pause mode is activated.

Page

Activates playback at the selected browsable picture on the loaded disc. This search mode is not available unless the loaded disc includes browsable pictures.

To activate search mode:

1. Press the remote control SEARCH button to open one of the search bars shown above at the top of the on-screen display.
 - The Time and Frame + Time search modes are not available unless playback or pause mode is activated.
 - The Search bar indicates the selected search mode.
2. When the search bar opens, press the SEARCH button again to cycle through all search modes available for the loaded disc. The table on page 4-12 indicates the search modes available for each disc format.

Note:

The search bar automatically closes a few seconds after the last command is received. When this occurs, search mode is automatically deactivated.

4. When the desired search mode is selected, press the remote control number buttons to enter a search value. It is not required to press the +10 button (2-15) to enter values 10 and above. For example:
 - To enter Title 6, press the number 6 button.
 - To enter Track 16, press the number 1 button, then the number 6 button.
 - To enter a playback time of 16 minutes and 16 seconds, press the number 1 button, the number 6 button, the number 1 button, then the number 6 button.
 - Press the remote control CLEAR button to delete an incorrect search value.
 - To deactivate search mode, press the SEARCH button until the search bar closes.

... Search Mode continues on page 4-30

Search Mode (continued from page 4-29)

5. When the desired search value is entered, press the Play button or the remote control ENTER button to activate playback at the selected playback time.
 - If a valid search value was entered, playback will activate at the selected title, chapter, group, track, folder, playback time, or browsable picture.
 - If an invalid search value was entered, the search bar will close without activating playback.

DISPLAY MODE



- The remote control DISPLAY button can be used to activate display mode, which opens an on-screen display screen or bar that provides information about the loaded disc.
- Display screens are available when stop or resume mode is activated. Display bars are available when playback or pause mode is activated.
- The display screens descriptions that begin in the next column indicate the display screens available for each disc format.
- The display bars descriptions that begin on page 4-32 indicate the display bars available for each disc format.

Display Screens

The letters in the display screen illustrations shown at the top of the next page correspond to the lettered items below.

Display Screen A DVD-V
 Indicates the number of chapters included in each title on the loaded disc.

Display Screen B DVD-A
 Indicates the number of tracks included in each group on the loaded disc.

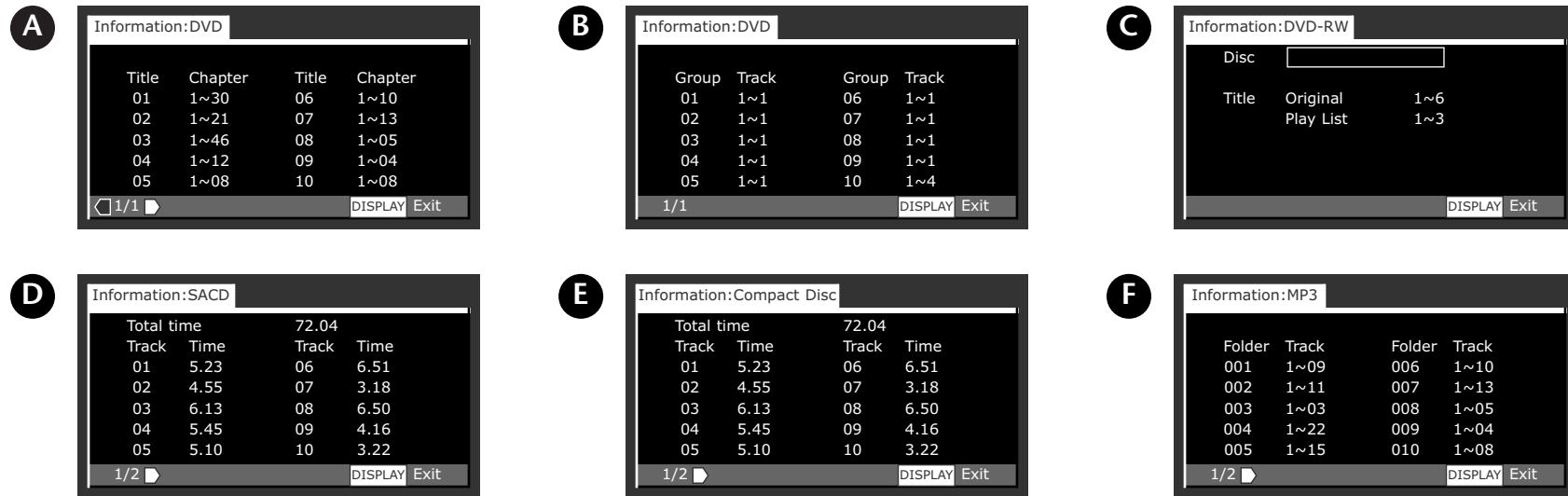
Display Screen C DVD-RW/R
 Indicates the name of the loaded disc (if available), as well as the number of titles included on the recorded and programmed versions of the disc.

Display Screen D SACD
 Indicates the total playback time of the loaded disc and the total playback time of each track included on the loaded disc.

Display Screen E CD, SVCD
 Indicates the total playback time of the loaded disc and the total playback time of each track included on the loaded disc.

Display Screen F MP3
 Indicates the number of tracks included in each folder on the loaded disc.

Display Screens



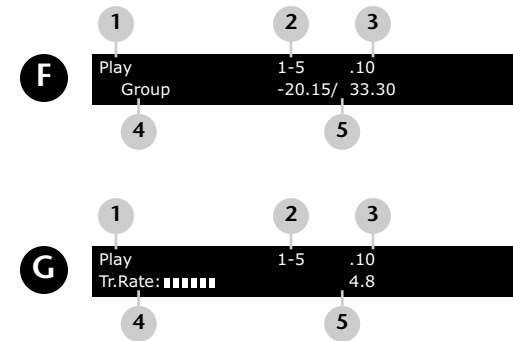
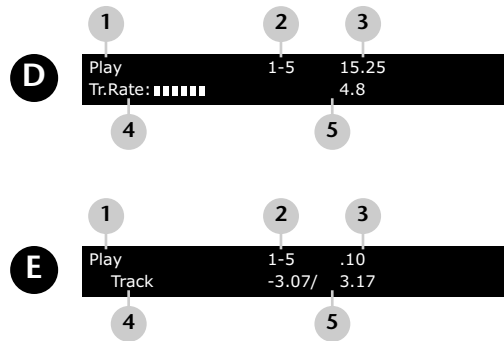
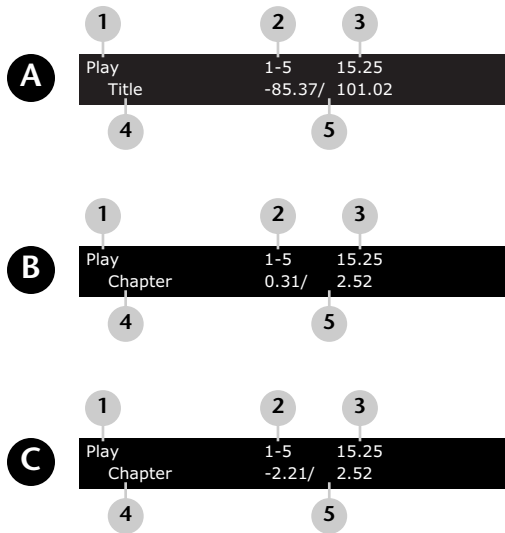
To open a display screen:

1. Make sure stop or resume mode is activated.
2. When stop or resume mode is activated, press the remote control DISPLAY button to open one of the display screens shown above. The display screen descriptions on the previous page indicate the display screens available for each disc format.

To deactivate display mode:

Press the DISPLAY button to close the display screen.

Display Bars



The letters and numbers in the display bar illustrations shown here and at the top of the next page correspond to the numbered items in the tables that begin below.

Display Bar A

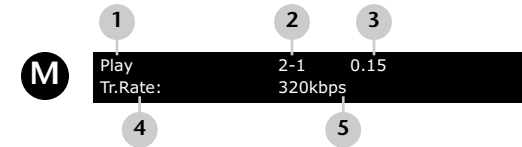
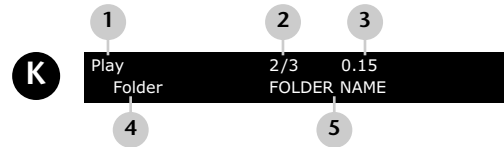
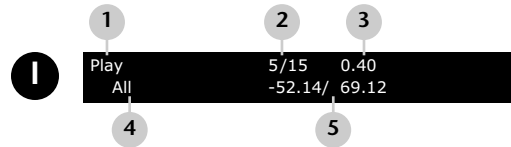
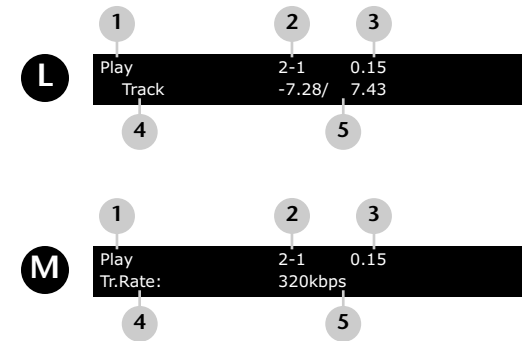
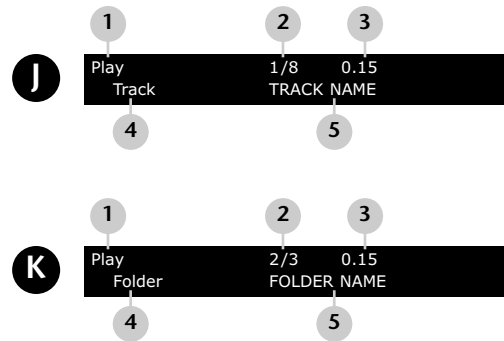
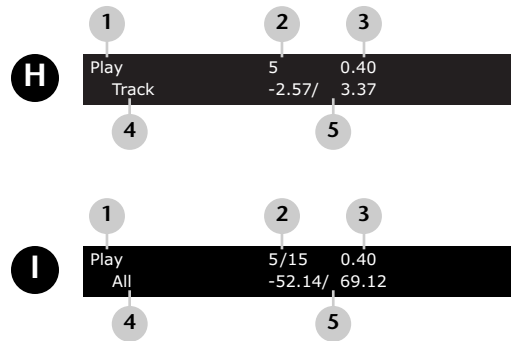
DVD-V

No.	Description
1	Indicates whether playback or pause mode is activated.
2	Indicates the numbers of the currently playing title and chapter.
3	Indicates the elapsed playback time of the currently playing title (minutes.seconds).
4	Indicates the display bar format.
5	Indicates the remaining and total playback time of the loaded disc.

Display Bar B

DVD-V

No.	Description
1	Indicates whether playback or pause mode is activated.
2	Indicates the numbers of the currently playing title and chapter.
3	Indicates the elapsed playback time of the currently playing title (minutes.seconds).
4	Indicates the display bar format.
5	Indicates the elapsed and total playback time of the currently playing chapter.



Display Bar C

DVD-V

No.	Description
1	Indicates whether playback or pause mode is activated.
2	Indicates the numbers of the currently playing title and chapter.
3	Indicates the elapsed playback time of the currently playing title (minutes.seconds).
4	Indicates the display bar format.
5	Indicates the remaining and total playback time of the currently playing chapter.

Display Bar D

DVD-V

No.	Description
1	Indicates whether playback or pause mode is activated.
2	Indicates the numbers of the currently playing title and chapter.
3	Indicates the elapsed playback time of the currently playing title (minutes.seconds).
4	Indicates the display bar format.
5	Indicates the current transmission rate.

... Display Bars continues on page 4-34

Display Bars (continued from page 4-33)

The letters and numbers in the display bar illustrations shown on pages 4-32 and 4-33 correspond to the numbered items in the tables that continue below.

Display Bar E

DVD-A

No.	Description
1	Indicates whether playback or pause mode is activated.
2	Indicates the numbers of the currently playing group and track.
3	Indicates the elapsed playback time of the currently playing track.
4	Indicates the display bar format.
5	Indicates the remaining and total playback time of the currently playing track.

Display Bar F

DVD-A

No.	Description
1	Indicates whether playback or pause mode is activated.
2	Indicates the numbers of the currently playing group and track.
3	Indicates the elapsed playback time of the currently playing track.
4	Indicates the display bar format.
5	Indicates the remaining and total playback time of the currently playing group.

Display Bar G

DVD-A

No.	Description
1	Indicates whether playback or pause mode is activated.
2	Indicates the numbers of the currently playing group and track.
3	Indicates the elapsed playback time of the currently playing track.
4	Indicates the display bar format.
5	Indicates the current transmission rate.

Display Bar H

SACD, CD, SVCD

No.	Description
1	Indicates whether playback or pause mode is activated.
2	Indicates the numbers of the currently playing track.
3	Indicates the elapsed playback time of the currently playing track.
4	Indicates the display bar format.
5	Indicates the total playback time of the currently playing track.

Display Bar I

SACD, CD, SVCD

No.	Description
1	Indicates whether playback or pause mode is activated.
2	Indicates the numbers of the currently playing track and the total number of tracks on the loaded disc.
3	Indicates the elapsed playback time of the currently playing track.
4	Indicates the display bar format.
5	Indicates the total playback time of the loaded disc.

Display Bar J

MP3

No.	Description
1	Indicates whether playback or pause mode is activated.
2	Indicates the numbers of the currently playing track and the total number of tracks in the currently playing folder.
3	Indicates the elapsed playback time of the currently playing track.
4	Indicates the display bar format.
5	Indicates the name of the currently playing track.

Display Bar K

MP3

No.	Description
1	Indicates whether playback or pause mode is activated.
2	Indicates the numbers of the currently playing folder and the total number of folders on the loaded disc.
3	Indicates the elapsed playback time of the currently playing track.
4	Indicates the display bar format.
5	Indicates the name of the currently playing folder.

Display Menu L

MP3

No.	Description
1	Indicates whether playback or pause mode is activated.
2	Indicates the numbers of the currently playing folder and track.
3	Indicates the elapsed playback time of the currently playing track.
4	Indicates the display bar format.
5	Indicates the remaining and total playback time of the currently playing track.

. . . Display Bars continues on page 4-36

Display Bars (continued from page 4-35)

The letters and numbers in the display bar illustrations shown on pages 4-32 and 4-33 correspond to the numbered items in the tables that continue below.

To deactivate display mode:

Press the DISPLAY button until the display bar closes.

Display Bar M

MP3

No.	Description
1	Indicates whether playback or pause mode is activated.
2	Indicates the numbers of the currently playing folder and track.
3	Indicates the elapsed playback time of the currently playing track.
4	Indicates the display bar format.
5	Indicates the current transmission rate.

To open a display bar:

1. Make sure playback or pause mode is activated.
2. When playback or pause mode is activated, press the remote control DISPLAY button to open one of the display bars shown on pages 4-32 and 4-33. The tables that begin on page 4-32 indicate the display bars available for each disc format.
3. Press the DISPLAY button again to cycle through all display bars available for the loaded disc.

Troubleshooting & Maintenance

Troubleshooting	5-2
<i>Power Issues • Remote Control Issues • Video Output Issues • Audio Output Issues • Playback Issues • Setup Menu Issues • Playback Control Issues • Miscellaneous Issues</i>	
RT-10 Maintenance	5-15
Disc Maintenance	5-16
Restoring Factory-Default Settings	5-16

TROUBLESHOOTING

Incorrect operation is sometimes mistaken for malfunction. If problems occur, refer to this section for troubleshooting information or visit www.lexicon.com for additional troubleshooting information and answers to frequently asked questions. If problems persist, contact Lexicon Customer Service at 781-280-0300 or www.lexicon.com.

POWER ISSUES

The RT-10 will not power on.

1. Power the RT-10 on with the front panel On/Off button.
2. Deactivate standby mode. If the RT-10 is not configured for trigger control, press the remote control POWER button to deactivate standby mode. If the RT-10 is configured for trigger control, use component connected to the RT-10 trigger input connector to deactivate standby mode.
3. Make sure the power cord is connected to the AC input connector and the electrical outlet.

Standby mode automatically activates.

1. Set the AUTO_P parameter (3-52) to OFF. When this parameter is set to On, the RT-10 automatically activates standby mode after 30 minutes of non-use.

REMOTE CONTROL ISSUES

The remote control seems to stop working.

1. Make sure the remote control batteries are correctly inserted with the proper polarity (1-9).

2. Replace the remote control batteries (1-9). The remote control requires two AA batteries that should be replaced as needed. It is strongly recommended to use Alkaline batteries, which last longer without leaking.
3. If the RT-10 is not using the IR IN connector, make sure the remote control is in line-of-sight with the front panel display remote control sensor. Eliminate obstructions between the remote control and the remote control sensor. The remote control might become unreliable if strong sunlight or fluorescent light is shining on the remote control sensor.
4. Make sure the remote control is positioned within its operating range (2-14). The remote control should be positioned at a 30-degree angle no more than 17 feet (5m) from the RT-10. If the RT-10 is placed inside a glass cabinet, smoked glass might reduce the remote control range.
5. Make sure the same command mode (3-53) is assigned to the remote control and the RT-10. The remote control can only be used to operate an RT-10 to which the same command mode is assigned. The remote control cannot be used to operate an RT-10 to which a different command mode is assigned, except to configure Advanced Setup menu parameter settings.
6. If playback is activated, press the Stop button to activate stop mode, then press the Play button to activate playback from the beginning of the loaded disc. In some cases, this will restore functionality.
7. Power cycle the RT-10 with the front panel On/Off button. In some cases, this will restore functionality.

The remote control number buttons cannot be used to enter values 10 and above.

1. In some cases, the remote control +10 button must be used to enter values 10 and above. Press the +10 button once for numbers in the teens, twice for numbers in the twenties, and so on. Then, press the desired number button (0 to 9) to enter the second digit. For instance, entering a value of 25 requires a remote control command sequence of +10, +10, and 5.

VIDEO OUTPUT ISSUES

The RT-10 is powered on, but there is no video.

1. Examine the rear panel to ensure that the required video output connection (2-11) has been made and that video cables – particularly S-video cables – have been fully inserted.
2. Make sure all associated components are powered on and configured with the correct settings.
3. If the **VIDEO OFF** indicator appears on the front panel display, press the remote control VIDEO ON/OFF button to reactivate the video output connectors.
4. If the RT-10 has a component video output connection and the associated display device is not progressive-scan compatible, set the Component Video parameter (3-27) to Interlace or reconnect the RT-10 to the associated display device with an S-video or composite video output connection.

The picture on the associated display device screen appears stretched or otherwise distorted.

1. Set the TV Type prompt (3-5) or TV Screen parameter (3-25) to the appropriate setting for the associated display device.
2. Make sure all associated components – particularly display devices – are configured with the correct settings.
3. Press the remote control SETUP button to close the Setup menu. When the Setup menu is open while the TV Type prompt (3-5) or TV Screen parameter (3-25) is set to a 4:3 format, the screen automatically adjusts to 16:9 format (widescreen) to accommodate the Setup menu. When the Setup menu is closed, the screen automatically reverts to the selected 4:3 format.
4. Make sure the loaded disc allows video output format (aspect ratio) adjustments.

The picture on the associated display device screen includes video artifacts.

1. Stop executing commands. Depending on the format of the loaded disc, some commands might cause the picture to disappear or shake.
2. If the RT-10 has a component video output connection and the Component Video parameter (3-27) is set to Progressive, set the parameter to Interlace.
3. The loaded disc might include a copy-prevention signal (1-6). The RT-10 is compatible with Macro-Vision System copy guard. However, some discs include a copy prevention signal that produces video artifacts such as stripes in the picture.

. . . Video Output Issues continues on page 5-4

Video Output Issues *(continued from page 5-3)*

The picture on the associated display device screen includes video artifacts. *(continued)*

4. The RT-10 is not compatible with all high-definition display devices. In some cases, this connection might produce video artifacts in the picture.
5. The RT-10 includes copy-protection circuits that might prevent recording or produce video artifacts in the picture when the RT-10 is connected to a VCR or A/V selector.






RF interference is present in the video output.

1. Make sure the RT-10 is not positioned near unshielded TV or FM antennas, cable TV decoders, and other RF emitting devices that might cause interference. Replace unshielded cables with shielded cables whenever possible.

Still frame images shake.

1. Set the Still Picture parameter (3-35) to Field. When this parameter is set to Field, the RT-10 produces tight, stable, and generally shake-free still frame images.

An icon appears on the on-screen display.

1. The icon shown at the right appears on the on-screen display when the RT-10 does not allow the selected command. 
2. The icon shown at the right appears on the on-screen display when the loaded disc does not allow the selected command. 
3. The icon shown at the right appears on the on-screen display when a Setup menu parameter that is exclusive to DVD formats is adjusted while another disc format is loaded. These adjustments will take effect the next time a DVD is loaded. 
4. When the Setup menu is open, the icon shown at the right appears next to parameters for which Setup menu shortcuts (3-50) have been created. 
5. When the MP3 Navigator (4-4 and 4-27) is open, the icon shown at the right appears next to MP3 tracks that have been added to the MP3 program list. 

AUDIO OUTPUT ISSUES

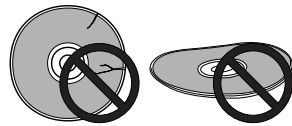
The RT-10 is powered on, but there is no audio.

1. Deactivate the following playback modes (if applicable): stop mode, resume mode, pause mode, still frame playback, frame-by-frame playback, and slow playback. Audio automatically mutes when these playback modes are activated.
2. Examine the rear panel to ensure that the required audio output connection (2-12) has been made and that audio cables have been fully inserted.

3. Make sure all associated components are powered on and configured with the correct settings. In particular, make sure volume is set to an audible level.
4. Make sure the RT-10 has a digital and an analog audio output connection (2-13). Some disc formats, such as DVD-As and SACDs, do not generate digital audio output signals.
5. Make sure the RT-10 is not connected to the phono (turntable) audio input connector on the associated component.
6. Clean the loaded disc (5-16).

CAUTION

Dirty or damaged discs such as those shown below might affect playback performance or damage the RT-10. Do not attempt to load cracked, chipped, scratched, warped, dirty, or otherwise damaged discs in the disc drawer.



7. Clean the RT-10 audio output connectors, the associated component audio input connectors, and the audio cable plugs to ensure that the connectors and plugs are not dirty or oxidized.

The RT-10 is powered on, but there is no digital audio.

1. If the **D OFF** indicator appears on the front panel display, set the Digital Out parameter (3-14) to On to reactivate the digital audio output connectors.

2. Make sure the loaded disc generates digital audio output signals. Some discs, such as DVD-As and SACDs, only generate analog audio output signals.
3. If the loaded disc does not allow audio downmixing, set the Audio Out parameter (3-16) to 5.1 Channel. Discs such as DVD-As that do not allow audio downmixing will mute the digital audio output connectors when the Audio Out parameter is set to 2 Channel.
4. Make sure the Dolby Digital, DTS, Linear PCM, and MPEG parameter (3-12 to 3-14) settings are compatible with the associated component. For instance, the Dolby Digital parameter should be set to Dolby Digital if the associated component is compatible with Dolby Digital sources and to Dolby Digital ▶ PCM if the associated component is not compatible with Dolby Digital sources.

The RT-10 is powered on, but there is no stereo audio.

1. Set the Audio Out parameter (3-16) to 2 Channel. When this parameter is set to 5.1 Channel, the RT-10 passes multi-channel audio output to the associated component.
2. Make sure the loaded disc allows audio downmixing. Discs such as DVD-As that do not allow audio downmixing always output multi-channel audio, even when the Audio Out parameter (3-16) is set to 2 Channel.
3. Make sure an audio track recorded in stereo format is selected on the loaded disc (4-7). The remote control AUDIO button or the disc menu can be used to select the desired audio track (audio language and output format).

... Audio Output Issues continues on page 5-6

Audio Output Issues (continued from page 5-5)

The RT-10 is powered on, but there is no multi-channel audio.

1. Set the Audio Out parameter (3-16) to 5.1 Channel. When this parameter is set to 2 Channel, the RT-10 passes 2-channel audio output to the associated component. Dolby Digital, DTS, and MPEG sources are downmixed to two channels, allowing playback of all audio channels recorded on the disc.
2. Make sure multi-channel audio is available on the loaded disc. Multi-channel audio is only available for DVD-As and SACDs, as well as other discs that include Dolby Digital, DTS, or MPEG encoding. Other discs always output 2-channel audio, even when the Audio Out parameter (3-16) is set to 5.1 Channel.
3. Make sure an audio track recorded in multi-channel format is selected on the loaded disc (4-7). The remote control AUDIO button or the disc menu can be used to select the desired audio track (audio language and output format).

The RT-10 automatically downsamples digital audio sources with high sample rates.

1. Set the Linear PCM Out parameter (3-13) to Down Sample Off. When this parameter is set to Down Sample On, the RT-10 automatically downsamples 96kHz PCM signals to 48kHz before passing them to the associated component.
2. If the loaded disc generates 192 or 176.4kHz signals, the RT-10 automatically downsamples these signals to 96 or 88.2kHz before passing them to the associated component. The RT-10 will not pass 192 or 176.4kHz signals, even when the Linear PCM parameter (3-13) is set to Down Sample Off.

3. If a DVD is loaded, the disc might have a copy-protection signal (1-6) that prevents it from generating 96kHz signals. When a copy-protection signal is present, the RT-10 automatically downsamples signals to 48kHz before passing them to the associated component, even if the Linear PCM parameter (3-13) is set to Down Sample Off.

A humming sound is present in the audio.

1. If a cable TV connection is present, disconnect the cable from the wall outlet. If this eliminates the humming sound, an isolation device is required. Contact the cable provider for assistance.
2. Disconnect components one at a time to isolate the problem. Once the problem is identified, make sure the component is properly grounded and connected to the same electrical circuit as the RT-10.

Dialog sounds muffled.

1. If the RT-10 has a stereo audio output connection, set the Audio Out parameter (3-16) to 2 Channel.
2. If the speaker setup does not include a center speaker, make sure a center speaker is not selected with the component that was used to configure speaker settings.
 - If the RT-10 was used to configure speaker settings, make sure the Speaker Size screen C parameter (3-22) is set to Off.
 - If the MC-12 or MC-8 Digital Controller was used to configure speaker settings, make sure the CUSTOM SETUP menu CENTER parameter is set to NONE.

RF interference is present in the audio output.

1. Make sure the RT-10 is not positioned near unshielded TV or FM antennas, cable TV decoders, and other RF emitting devices that might cause interference. Replace unshielded cables with shielded cables whenever possible.

Volume level seems to differ between DVDs and CDs.

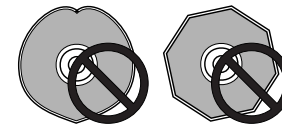
1. DVDs and CDs are recorded with different processes, which might cause them to output audio at different volume levels.

The RT-10 will not pass Dolby Digital, DTS, or MPEG signals to the associated component.

1. Make sure the Dolby Digital, DTS, and MPEG parameter (3-12 to 3-14) settings are compatible with the associated component. For instance, the Dolby Digital parameter should be set to Dolby Digital if the associated component is compatible with Dolby Digital sources and to Dolby Digital ▶ PCM if the associated component is not compatible with Dolby Digital sources.
2. Make sure all associated components are configured with the correct settings.

PLAYBACK ISSUES**The disc drawer automatically opens when a disc is loaded.**

1. Make sure a compatible disc is loaded. The RT-10 is compatible with 5-inch (12cm) and 3-inch (8cm) conventional, round discs. Do not attempt to load discs with other size and shape characteristics, such as those shown below. All discs must align with the circular guide inside the disc drawer.



2. Make sure a compatible disc format is loaded (1-5).
3. If a DVD-V is loaded, make sure the RT-10 region code is compatible with the DVD-V region code. The map shown on page 1-4 indicates DVD-V region codes for all areas of the world. All DVD-Vs are marked with a region code, which is often located on the disc packaging. The RT-10 rear panel is also marked with a region code (2-8). The RT-10 is compatible with discs marked with this same region code or with the ALL region code. The RT-10 is not compatible with discs marked with other region codes.
4. Clean the loaded disc (5-16).
5. Condensation might have formed on the RT-10 lens (1-4). If this occurs, allow at least 1 hour for condensation to evaporate before attempting to load a disc.

. . . Playback Issues continues on page 5-8

Playback Issues (continued from page 5-7)

Playback will not activate.

1. Make sure a compatible disc format is loaded (1-5).
2. Make sure the disc is properly loaded (4-2). Load single-sided discs with the label side facing upward and double-sided discs with the side intended for playback facing downward. All discs must align with the circular guide inside the disc drawer.
3. Close the disc menu (if applicable). Pressing the Play button might not activate playback when the disc menu is open on the on-screen display.

The selected playback mode will not activate.

1. Make sure the playback mode is compatible with the the loaded disc. The table on page 4-12 indicates the playback modes available for each disc format.
2. Some playback modes are automatically deactivated when certain remote control buttons are pressed. Refer to Section 4 for more information.

Playback will not activate when a DVD-RW/R is loaded.

1. The DVD-RW/R might be copy-once protected (1-6). The RT-10 does not allow playback of copy-once protected discs. When a copy-once protected disc is loaded, the message "COPY PROTECT PROGRAM. UNPLAYABLE." appears on the on-screen display.

Playback automatically stops when an DVD-A is loaded.

1. The disc might have been illegally copied. The RT-10 does not allow playback of DVD-As that have been illegally copied.

Playback activates for the selected SACD track, but the output format is incorrect.

1. Make sure the SACD Playback parameter (3-15) is set to the desired SACD output format.
2. Make sure the loaded SACD includes the selected track. If the SACD Playback parameter (3-15) is set to a track that is not available on the loaded SACD, the RT-10 automatically selects an alternate track.

Playback will not activate when an MP3 is loaded.

2. An incompatible MP3 track might be selected (1-7). When the MP3 Navigator (4-4 and 4-27) is open and an incompatible MP3 track is selected, the icon shown at the right appears on the on-screen display. When the MP3 Navigator is closed and an incompatible MP3 track is selected, the message "UNPLAYABLE MP3 FORMAT" appears on the on-screen display.
2. The RT-10 might require a few seconds to activate playback of an MP3 track that is included in a complex MP3 file structure. When this occurs, the message "Please wait a moment" appears on the on-screen display.



Some MP3 tracks appear to be missing from the loaded disc.

1. The RT-10 recognizes a maximum of 250 folders per disc and 250 tracks per folder. It ignores all folders and tracks that exceed this number.

Playback does not begin from a bookmarked playback time on the loaded disc.

1. Playback might have automatically activated from the beginning of the disc when the disc was loaded. If this occurs, press the Stop button to activate stop mode. Then, press the remote control LAST MEMO button to activate playback from the bookmarked playback time.
2. Make sure a DVD-V, DVD-RW/R or Video CD that does not include PBC menus is loaded. Last memory playback is not available for other disc formats. The table on page 4-12 indicates the playback modes available for each disc format.
3. The bookmark might have been deleted. **The oldest bookmark is automatically deleted when the sixth bookmark is created.** Video CD bookmarks are automatically deleted when the disc drawer is opened or when the RT-10 is powered off. All bookmarks are automatically deleted when factory-default settings are restored.

SETUP MENU ISSUES**The Setup Navigator automatically activates when the Setup Menu is opened.**

1. When factory-default settings are restored, the Setup Navigator prompt (3-4) automatically opens on the on-screen display whenever the remote control SETUP button is pressed while stop mode is activated. If this occurs, select the Auto Start Off setting.

The Setup menu does not include some parameters.

1. Make sure the Setup Menu Mode parameter (3-9 and 3-42) is set to Expert. When the Setup Menu Mode parameter is set to Basic, the Setup menu is displayed in basic mode, which only includes parameters that are required to configure the most common RT-10 settings.
2. The RT-10 is manufactured for sale in several different countries. Certain parameters are not available on some versions.

Setup menu parameters cannot be adjusted.

1. Certain parameters cannot be adjusted when some playback modes are activated. In addition, certain parameters can be adjusted when playback is activated, although the setting does not take effect until stop mode is activated.
2. Certain parameters cannot be adjusted when some disc formats are loaded (3-11).

... Setup Menu Issues continues on page 5-10

Setup Menu Issues (continued from page 5-9)

Setup menu parameter settings are cancelled.

1. Parameter settings might not have been stored if the RT-10 was powered off or standby mode was activated before the Setup menu was closed. If this occurs, all parameters are reset to their previously stored setting.
2. All Setup menu parameters are reset to their factory-default setting when a power failure (such as a power cord disconnect) occurs or factory-default settings are restored.

Note:

Whenever possible, power the RT-10 off or activate standby mode instead of disconnecting the power cord.

Setup menu parameter settings seem ineffective.

1. Certain Setup menu parameter settings have no effect on some disc formats (3-11).
2. If playback is activated, press the Stop button to activate stop mode. Some Setup menu parameters can be adjusted when playback is activated, even though the setting does not take effect until stop mode is activated.

Speaker settings seem ineffective.

1. Certain speaker settings have no effect on some disc formats. For instance, speaker size settings (3-19) have no effect on DVD-As and speaker distance settings (3-20) have no effect on SACDs.
2. Make sure the RT-10 and all associated components are configured with the correct speaker settings. RT-10 speaker settings do not need to be configured when the RT-10 is connected to an associated component such as the MC-12 Digital Controller, which allows speaker settings to be configured for analog audio sources. The associated component must not be using analog audio connections in bypass.

Variable output level settings seem ineffective.

1. Make sure the CD Digital Direct parameter (3-24) is set to Off. When this parameter is set to On, variable output level settings are ineffective.
2. Make sure the RT-10 and all associated components are configured with the correct output level settings. RT-10 variable output levels do not need to be configured when the RT-10 is connected to an associated component such as the MC-12 or MC-8 Digital Controller, which allows output levels to be calibrated for analog audio sources.

Test Tones (3-21) will not activate.

1. Press the Stop button to activate stop mode. Test Tones cannot be activated when playback, resume, or pause mode is activated.

2. Close the disc drawer. Test tones cannot be activated when the disc drawer is open.
3. Set the Analog Jacks prompt (3-5) or the Audio Out parameter (3-16) to 5.1 Channel. Test tones cannot be activated when these parameters are set to 5.1 Channel or None.
4. Set the Screen Saver parameter (3-28) to Off. Test Tones automatically mute when the Lexicon screen saver appears on the on-screen display.

Video Adjust bars exceed the on-screen display margins.

1. In some cases, the loaded disc might cause the Video Adjust bar to exceed on-screen display margins. If this occurs, close the Video Adjust bar and remove the loaded disc from the disc drawer. Then, open the Video Adjust bar again.

Previewed Video Adjust bank settings do not disappear.

1. Select a new Video Adjust bank (3-34) to cancel the previewed settings. The selected bank settings will be automatically applied to the picture on the associated display device screen.
2. Press the remote control VIDEO ADJ. button (2-18) to close the Video Adjust bar or screen.

Subtitles do not appear on the on-screen display.

1. Make sure a disc recorded with subtitles is loaded. Subtitles are not available for discs that are not recorded with subtitles.

The Parental Lock Level (3-45) and Country Code (3-47) controls are not available.

1. Make sure the Parental Lock Password control (3-42) has been used to assign a password. The Level and Country Code controls are not available unless a password has been assigned.
2. When the Level control is used to assign a security level, the Country Code control is not available.

The password has been lost or forgotten.

1. Restore factory-default settings (5-16). Unfortunately, restoring factory-default settings also resets all Setup and Advanced Setup menu parameters to their factory-default settings and deletes all Setup menu shortcuts, bookmarks, preferred disc settings, and program lists.

Setup menu shortcuts (3-50) cannot be created.

1. Make sure a Setup menu shortcut can be created for the selected parameter. Shortcuts cannot be created for the following parameters: Linear PCM Out, SACD Playback, TV Screen, Audio Language, Subtitle Language, Auto Language, DVD Language, Subtitle Display, Subtitle Off, Setup Navigator, Parental Lock, Bonus Group, and Group Playback.
2. Make sure the Function Memory tab (3-50) is not full. Setup menu shortcuts can be created for up to five Setup menu parameters, excluding those listed in the previous bullet. If five shortcuts have been created, one shortcut must be deleted before another can be created.

. . . Setup Menu Issues continues on page 5-12

Setup Menu Issues (continued from page 5-11)

The Advanced Setup menu will not open.

1. Press the Stop button to activate stop mode. The Advanced Setup menu cannot be opened unless stop mode is activated.
2. Press the remote control SETUP button to close the Setup menu. The Advanced Setup menu cannot be opened when the Setup menu is open.

The DISP_MODE parameter is set to ON, but the front panel display is still activated.

1. Make sure playback of an SACD, CD, or MP3 is activated. When the DISP_MODE parameter is set to ON, the RT-10 deactivates the front panel display during SACD, CD, or MP3 playback. The front panel display is not deactivated when other disc formats are loaded or when stop, resume, or pause mode is activated.
2. The DISP_MODE parameter might not function as described on page 3-52 with some SACDs, CDs, or MP3s. If this occurs, set the DISP_MODE parameter to DISP_OFF so the front panel display and rear panel video output connectors will function as normal.

PLAYBACK CONTROL ISSUES

The disc menu (4-3) will not open.

1. Attempt to open the disc menu with the remote control MENU button and TOP MENU buttons. In some cases, pressing these buttons opens the same disc menu. In some cases, one specific button must be pressed to open the disc menu. For instance, the TOP MENU button must be pressed to open DVD-A top menus.
2. Make sure a disc format that includes a disc menu is loaded. SACDs, CD-RW/Rs (except those that include MP3 tracks), and Audio CDs do not include disc menus.

Preferred disc settings (4-10) cannot be stored.

1. Make sure a DVD-V is loaded. Preferred disc settings cannot be stored for other disc formats.
2. Make sure the loaded DVD-V allows selection of on-screen display disc menu language, audio track (audio language or output format), camera angle, subtitle language, Video Adjust, or parental security level settings. Preferred disc settings cannot be stored for other disc formats or for DVD-Vs that do not allow at least one of these selections.
3. Preferred disc settings cannot be stored for selections the loaded DVD-V does not allow. For instance, if the loaded DVD-V does not allow selection of an on-screen display disc menu language setting, a preferred on-screen display disc menu language setting cannot be stored. However, preferred disc settings can still be stored for other selections the loaded DVD-V allows.

Preferred disc settings (4-10) are not recalled when a disc is loaded.

1. Make sure a DVD-V is loaded. Preferred disc settings cannot be stored (or recalled) for other disc formats.
2. The preferred disc settings might have been deleted. Preferred disc settings can be stored for up to 15 discs. **The oldest set of preferred settings is automatically deleted when the sixteenth set of preferred settings is stored.** Preferred disc settings are also deleted when factory-default settings are restored.

The remote control AUDIO button cannot be used to select an audio track (4-7).

1. Make sure a DVD-V, Video CD, or MP3 recorded with two or more audio tracks is loaded. Audio track selection is not available for other disc formats or for discs recorded with one audio track.
2. Activate playback. Audio track selection is not available unless playback is activated.
3. The disc menu might allow selection of the desired audio track.

The remote control SUBTITLE button cannot be used to select a subtitle language (4-8).

1. Make sure a DVD-V recorded with subtitles is loaded. Subtitle language selection is not available for other disc formats or for discs that are not recorded with subtitles.
2. Activate playback. Subtitle language selection is not available unless playback is activated.

3. The disc menu might allow selection of the desired subtitle language.

The remote control ANGLE button cannot be used to select a camera angle (4-9).

1. Make sure playback of a DVD-V scene recorded from multiple camera angles is activated. Camera angle selection is not available for other disc formats or for DVD-V scenes recorded from one camera angle. In addition, camera angle selection is not available unless playback is activated.
2. The disc menu might allow selection of the desired camera angle.

A program list (4-22) cannot be created.

1. Make sure the selected program list is available for the loaded disc. The table on page 4-23 indicates the program lists available for each disc format.
2. If a Video CD or SVCD is loaded, activate stop or resume mode. Video CD and SVCD program lists cannot be created when playback or pause mode is activated.

... Playback Control Issues continues on page 5-14

Playback Control Issues (continued from page 5-13)

A certain value cannot be added to a program list (4-22).

1. Program lists cannot contain values 100 and above or values that are not included on the loaded disc. For instance, a program title list cannot include a value of 5 if the loaded disc does not include title 5.
2. The program list must include at least one blank field before a new value can be inserted.

A program list is not stored.

1. Make sure a DVD-V or DVD-RW/R is loaded. Program lists cannot be stored for other disc formats.
2. Make sure the Program Memory parameter is set to On. When this parameter is set to On, program lists for the loaded disc are stored until factory-default settings are restored. When set to Off, program lists for the loaded disc are automatically deleted when the disc drawer is opened, standby mode is activated, the RT-10 is powered off, or factory-default settings are restored.

Program list modifications are not saved.

1. Program tabs automatically close a few seconds after the last command is received. When this occurs, all program list modifications that have not been previously stored will be deleted.

Program playback is in progress, and playback of a non-programmed chapter or track begins.

1. When playback of a program chapter or program track list is activated, playback of a non-programmed chapter or track might activate while the RT-10 searches for the next programmed chapter or track.

Search mode will not activate.

1. Make sure the search mode is compatible with the loaded disc. The table on page 4-12 indicates the search modes that are available for each disc format.
2. Close the disc menu. Some search modes might not activate when the disc menu is open on the on-screen display.
3. If frame + time search mode is selected:
 - Activate playback or pause mode. Frame + time search mode is not available when stop or resume mode is activated.
 - Make sure the Frame Search parameter (3-28) is set to On. frame + time search mode is not available when the Frame Search parameter is set to Off.
 - Some discs do not allow frame + time searches.

Some frames are skipped during frame-by-frame playback, or frame + time search mode does not find the selected frame number.

1. Make sure frame-by-frame playback or frame + time search mode is available for the loaded disc. The table on page 4-12 indicates the playback modes available for each disc format.

2. If the loaded disc was recorded in 24 frames-per-second progressive-scan format, the RT-10 misses one-in-six frames. Because of this, frame numbers appear discontinuous and the frame + time search mode might not find the selected frame.

MISCELLANEOUS ISSUES

The RT-10 is exhibiting erratic behavior.

1. Press the front panel On/Off button to power the RT-10 off. Wait 10 seconds. Then, press the On/Off button again to power the RT-10 on.
2. Record all user-defined settings on the installation worksheet that begins on page A-17. Then, follow the instructions on page 5-16 to restore factory-default settings.

If all else fails . . .

1. Press the front panel On/Off button to power the RT-10 off. Wait 10 seconds. Then, press the On/Off button again to power the RT-10 on.
2. Record all user-defined settings on the installation worksheet that begins on page A-17. Then, follow the instructions on page 5-16 to restore factory-default settings.
3. Contact an authorized Lexicon dealer.
4. Contact Lexicon Customer Service at 781-280-0300 or www.lexicon.com.

RT-10 MAINTENANCE

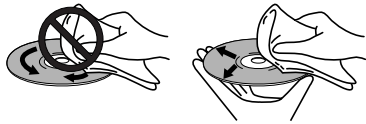
- The RT-10 exterior surface can be cleaned with a soft, dry, lint-free cloth. Do not use a cloth made with steel wool or metal polish. Do not soak the cloth in alcohol, benzene, acetone-based cleaners, or strong commercial cleaners. If the RT-10 is located in a dusty environment, a low-pressure blower can be used to remove dust from its exterior surface.
- Replace the remote control batteries as needed (1-9). The remote control requires two AA batteries. It is strongly recommended to use Alkaline batteries, which last longer without leaking.
- Refer to the Installation Considerations section that begins on page 1-3 for information about preventative maintenance.

Note:

The RT-10 lens should not become dirty or damaged from regular use. However, if malfunction occurs, contact an authorized Lexicon dealer for assistance. Do not attempt to clean the lens with a commercially available DVD or CD lens cleaner, as some of these products might damage the RT-10 lens.

DISC MAINTENANCE

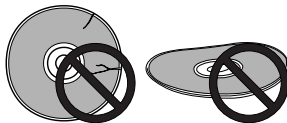
- Disc surfaces that have been marked with fingerprints, dust, or other dirt can be cleaned. Use a soft, dry, lint-free cloth to lightly wipe the disc from its center hole to outer edges. Wipe with straight strokes as shown below (right). Do not wipe with circular strokes as shown below (left).



- If needed, use a soft, lint-free cloth soaked in alcohol or a commercially available DVD or CD cleaning kit to clean the disc. Do not use benzene, thinner, or other cleaning products, including those designed to clean vinyl records.
- Refer to the Disc Care & Handling section that begins on page 1-8 for information about preventative maintenance.

CAUTION

Dirty or damaged discs such as those shown below might affect playback performance or damage the RT-10. Do not attempt to load cracked, chipped, scratched, warped, dirty, or otherwise damaged discs in the disc drawer.



RESTORING FACTORY-DEFAULT SETTINGS

Restoring factory-default settings resets all Setup and Advanced Setup menu parameters to their factory-default setting and deletes all passwords, Setup menu shortcuts, bookmarks, preferred disc settings, and program lists. Before restoring factory-default settings, it is recommended to record all user-defined settings on the installation worksheet that begins on page A-17.

Note:

Front panel buttons must be used to restore factory-default settings. Remote control buttons cannot be used.

To restore factory-default settings:

1. Record all user-defined settings on the installation worksheet that begins on page A-17.
2. If the RT-10 is powered off, proceed to step 3. If the RT-10 is powered on, press the front panel On/Off button to power the RT-10 off.
3. Press and hold the front panel Stop button.
4. While holding the Stop button, press the On/Off button to power the RT-10 on. The message "RESET OK" should appear on the front panel display. If it does not, factory-default settings have not been restored. Begin again with step 1. If problems persist, contact Lexicon Customer Service at 781-280-0300 or www.lexicon.com.

A

Appendix

Specifications	A-2
Declaration of Conformity	A-3
Setup Menu Screens	A-4
Table of Languages & Language Codes	A-14
Table of Country Codes	A-16
Installation Worksheet	A-17

SPECIFICATIONS

Note the following:

- The RT-10 is manufactured for sale in several different countries. Each version features a rear panel that includes connectors appropriate to that particular region. These specifications include all possible connectors. However, certain connectors are not included on some versions. These instances are noted in the rear panel connector descriptions that begin on page 2-8.
- DVD-A and SACD test discs were used to determine audio specifications. Typical production unit specifications might differ.
- Specifications are subject to change without notice.

Audio Output Connectors	
Analog	<ul style="list-style-type: none"> • 4 stereo (RCA) pairs for Front L/R (2 pairs), Surround L/R, Center, and Subwoofer
Digital	<ul style="list-style-type: none"> • 1 AES/EBU (XLR), 1 coaxial (RCA), and 1 optical (Toslink) • Sample Rates: 44.1, 48, 88.2, and 96kHz (16 to 24 bits) • All digital audio output connectors conform to IEC-958 and S/PDIF standards.

Audio Performance	
D/A Conversion	<ul style="list-style-type: none"> • 24-bit/192kHz PCM and pure DSD
Frequency Response	<ul style="list-style-type: none"> • 20Hz to 20kHz (± 0.5dB), -1.0dB at 50kHz, reference 1kHz (Front L/R)
THD + Noise	<ul style="list-style-type: none"> • 0.004% at 1kHz
Dynamic Range	<ul style="list-style-type: none"> • 100dB
Signal-to-Noise Ratio	<ul style="list-style-type: none"> • 100dB
Channel Separation	<ul style="list-style-type: none"> • 100dB
Output Level	<ul style="list-style-type: none"> • 2.0V maximum

Video Output Connectors	
Composite	<ul style="list-style-type: none"> • 2 (RCA)
S-Video	<ul style="list-style-type: none"> • 1
Component	<ul style="list-style-type: none"> • 2 (1 RCA and 1 BNC) and 14-pin D connector

Specifications are subject to change without notice.

Video Performance	
D/A Conversion	• 12-bit/108MHz
Bandwidth	• 6MHz
Signal-to-Noise Ratio	• 75dB (Y output)
Output Impedance	• 75Ω
Output Level	• 1.0V peak-to-peak

Other	
A/V Euroconnector	• 21-pin SCART connector
IR Input	• 3.5mm Tip/Ring/Sleeve
Trigger Input	• 12V DC • Detachable screw terminals
Power Requirements	• 120VAC, 50 to 60Hz (North & South American models) • 230VAC, 50 to 60Hz (European & Korean models) • 100VAC, 50 to 60Hz (Japanese Model)
Power Consumption	• 20W
Dimensions & Weight	• Width: 17.3 inches (440mm) • Height: 3.7 inches (94mm) • Depth: 12.2 inches (310mm) • Weight: 17.2 pounds (7.8kg)
Operating Temperature	• 5 to 35°C (41 to 95°F)
Relative Humidity	• 85% maximum (no condensation)
Rack Mounting	• Optional brackets are available for mounting the RT-10 in a standard 19-inch equipment rack

Specifications are subject to change without notice.

DECLARATION OF CONFORMITY

Application of Council Directive(s):

89/336/EEC and 93/68/EEC

Standard(s) to which Conformity is Declared:

- EN55013:1990 + A12:1994 + A13:1996 + A14:1999
- EN55020:1994 + A11:1996 + A12:1999 + A13:1999 + A14:1999
- EN60065:1998
- EN60825-1:1994 + A11
- EN61000-3-2:1995 + A1:1998 + A2:1998 + A14:2000
- EN61000-3-3:1995

Manufacturer: Lexicon, Inc.
3 Oak Park
Bedford, MA 01730-1413 USA

The equipment identified here conforms to the Directive(s) and Standard(s) specified above.

Type of Equipment: Disc Player

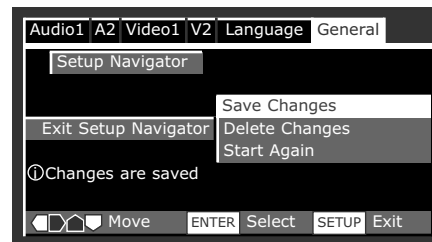
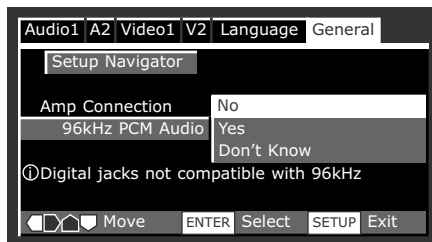
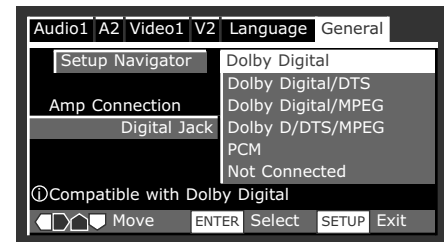
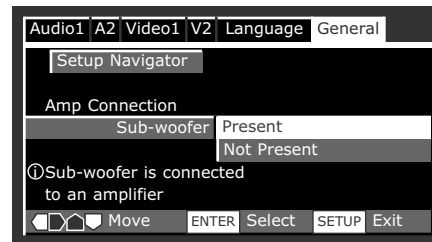
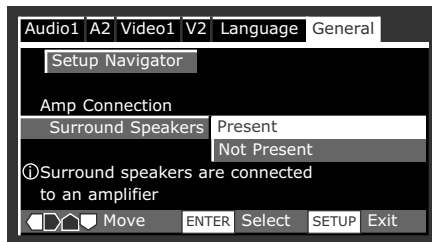
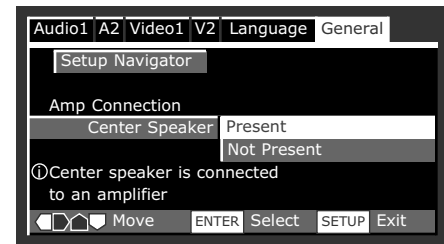
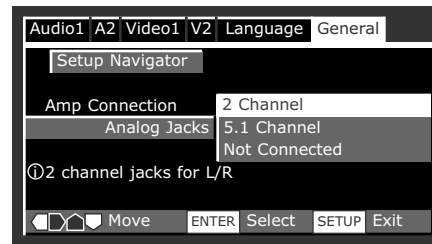
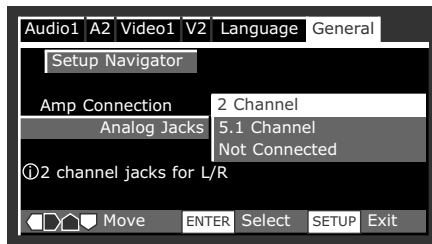
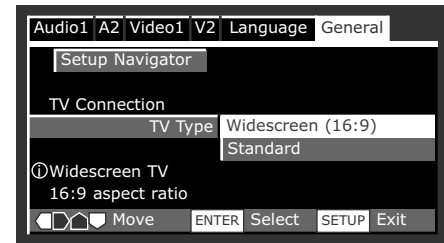
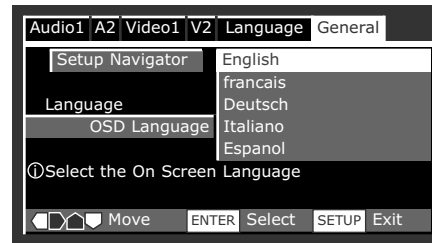
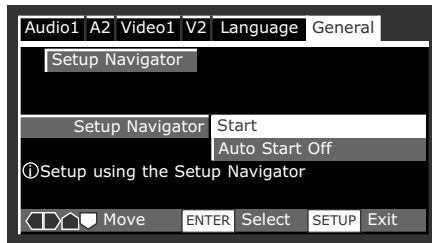
Model: Lexicon RT-10

Date: February 2003

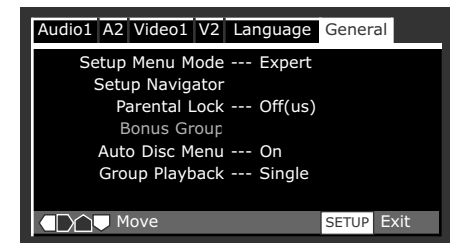
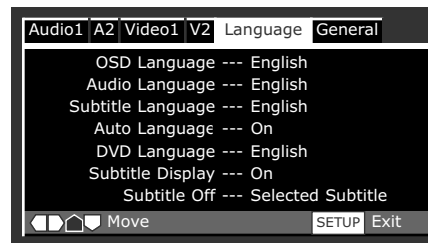
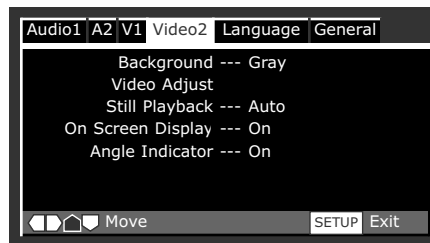
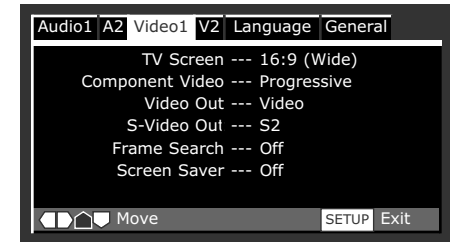
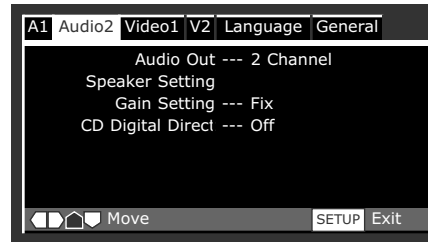
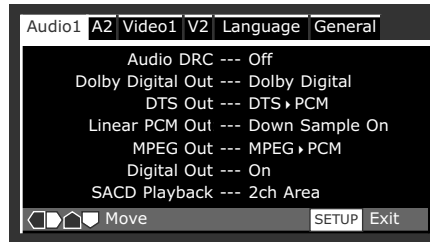
Lexicon, Inc.
Vice President of Engineering
3 Oak Park
Bedford, MA 01730-1413 USA
Tel: 781-280-0300
Fax: 781-280-0490

SETUP MENU SCREENS

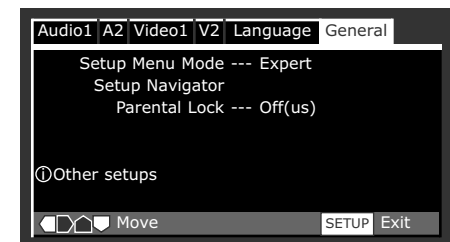
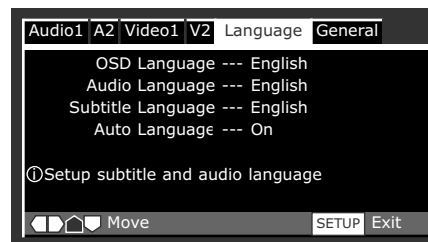
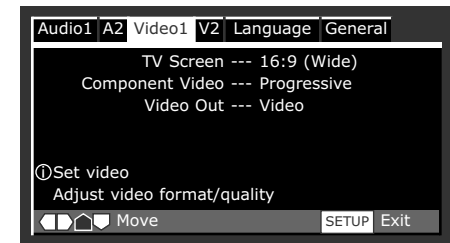
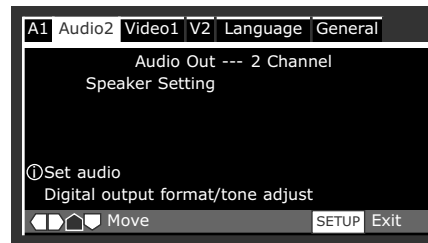
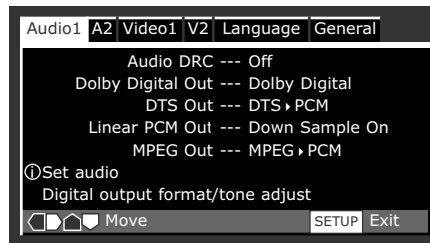
Setup Navigator Screens



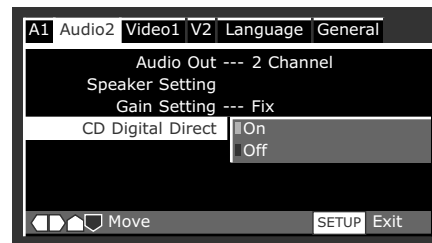
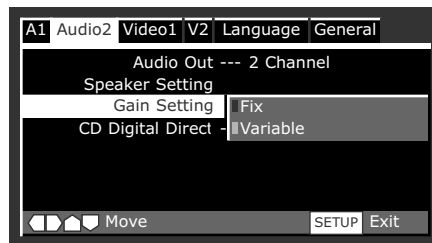
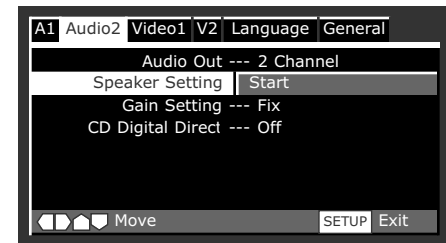
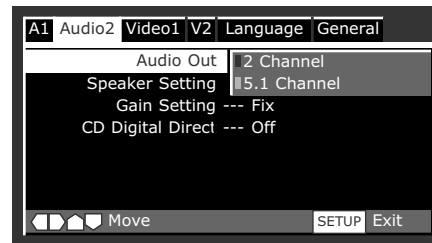
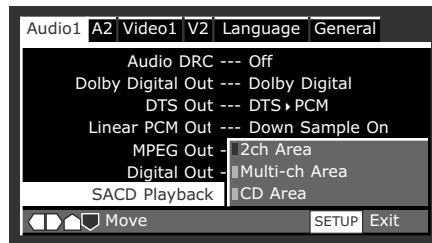
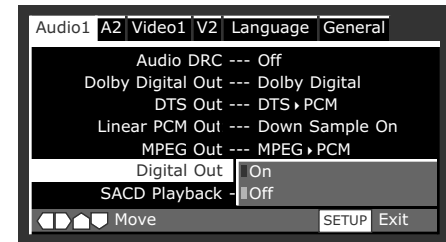
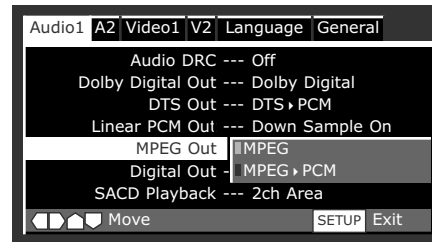
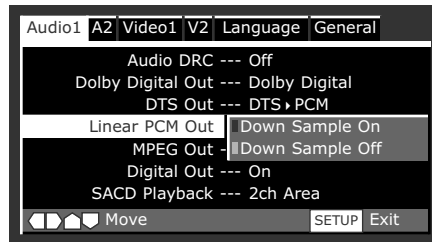
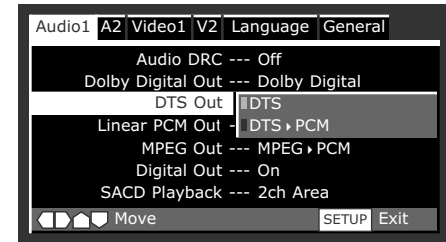
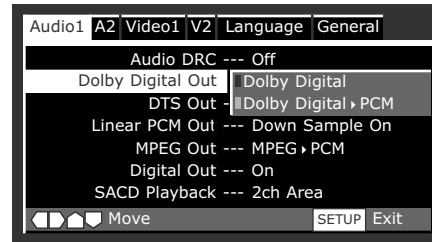
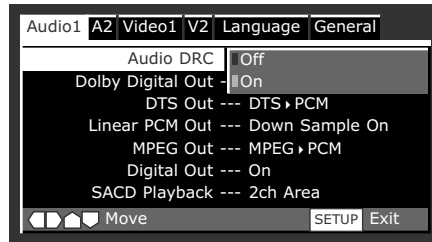
**Setup Menu Screens
(Expert Mode)**



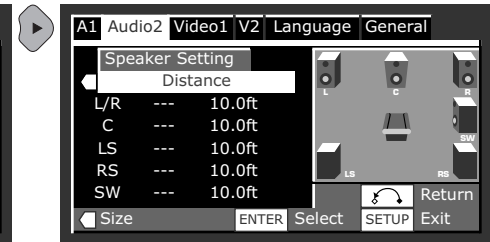
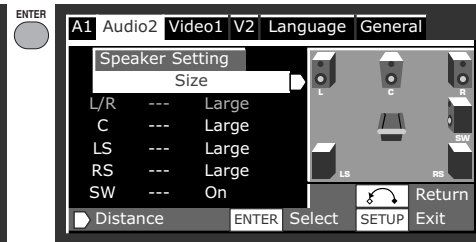
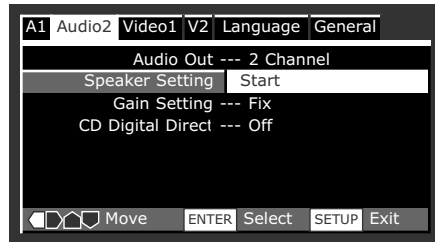
**Setup Menu Screens
(Basic Mode)**



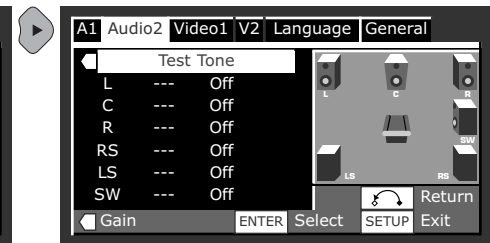
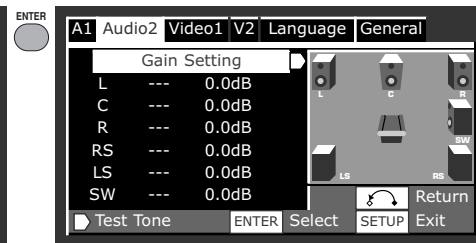
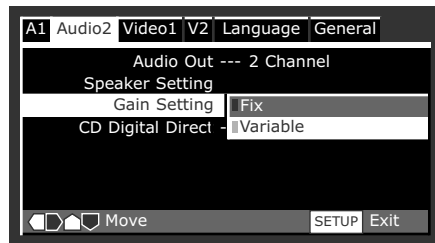
Audio 1 & 2 Tabs



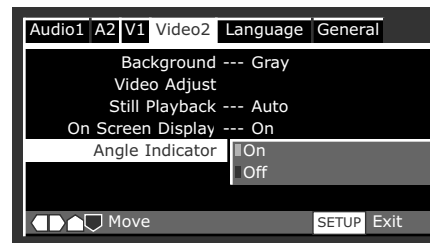
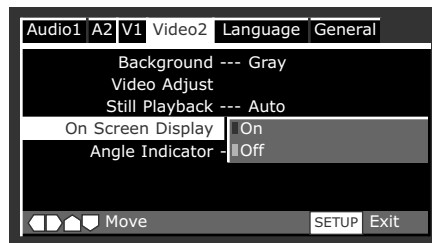
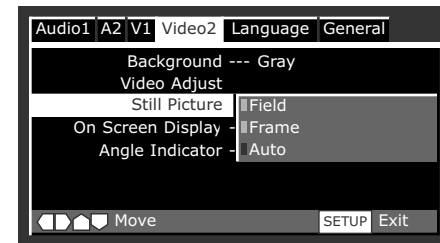
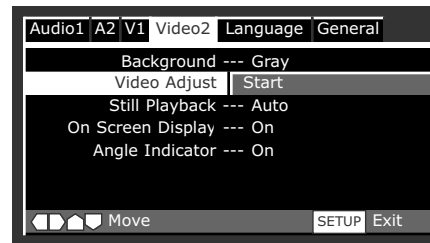
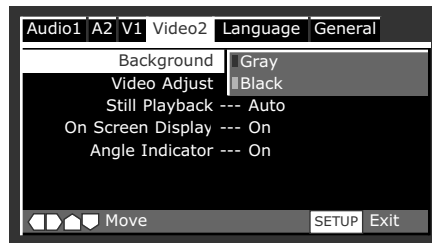
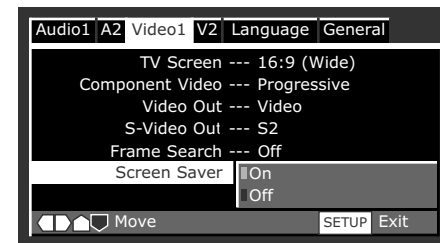
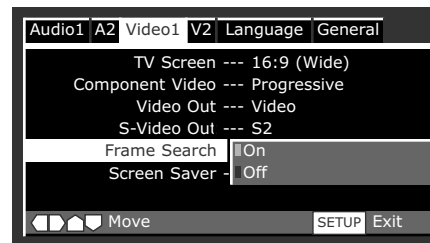
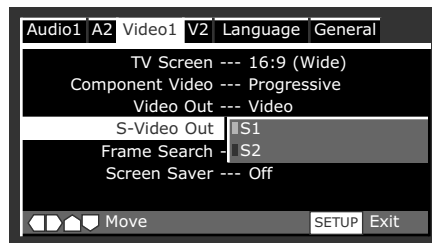
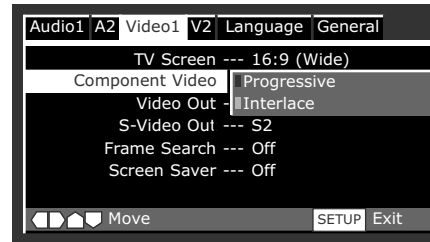
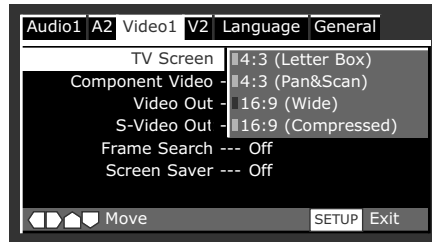
Speaker Setting Screens



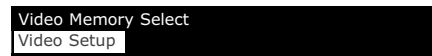
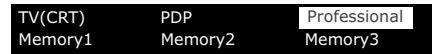
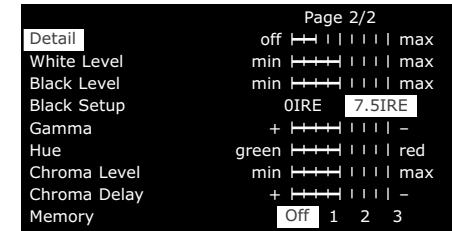
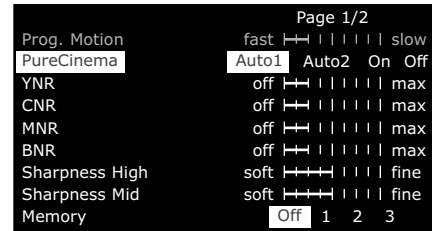
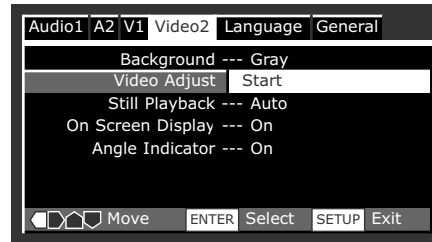
Gain Setting Screens



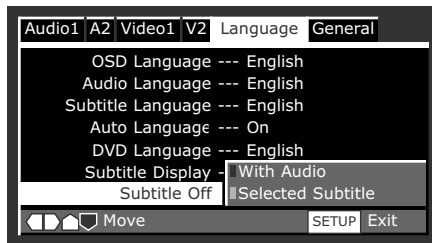
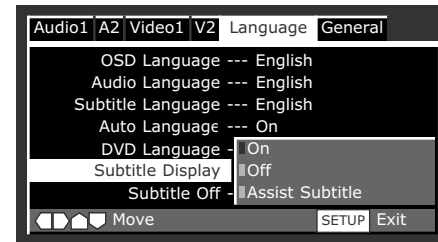
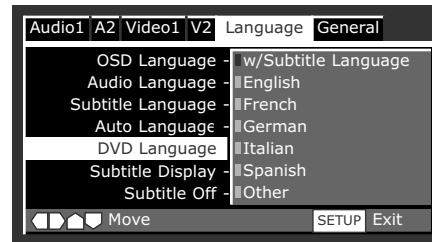
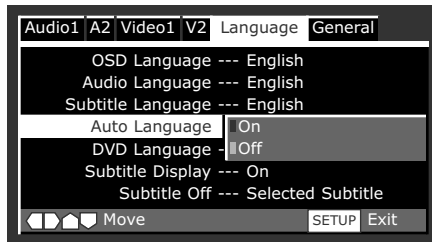
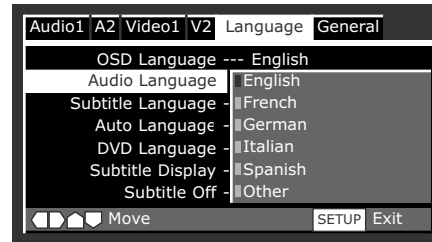
Video 1 & 2 Tabs



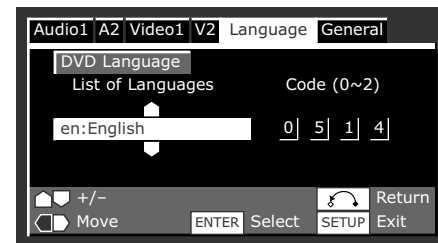
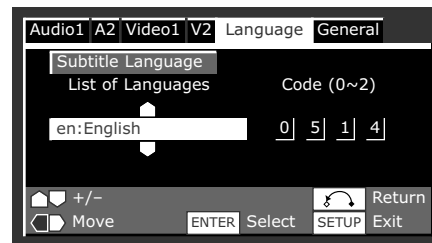
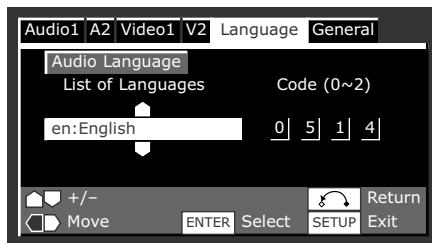
Video Adjust Screens



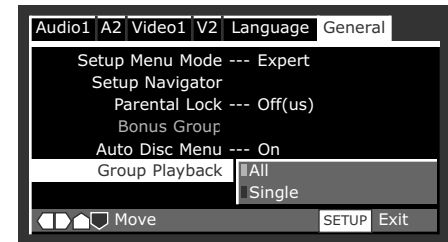
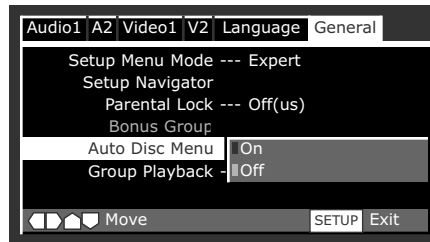
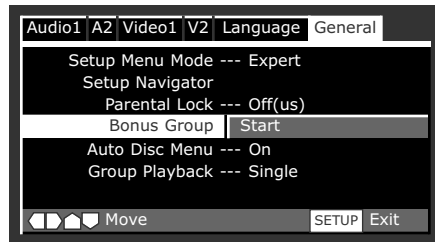
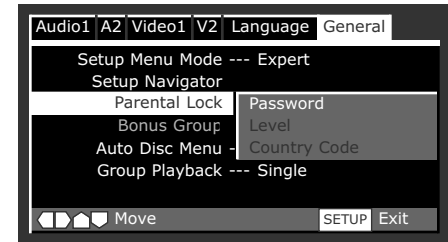
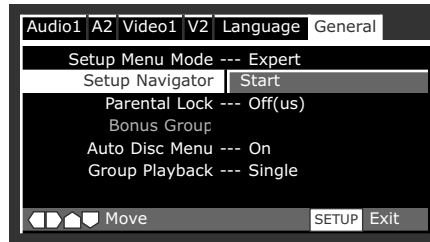
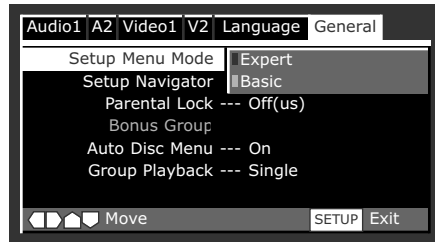
Language Tab



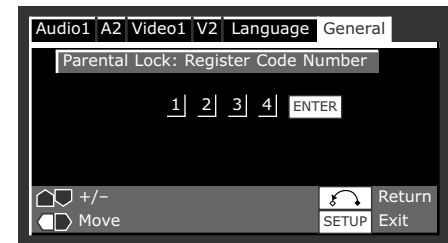
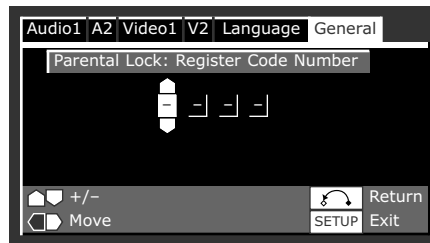
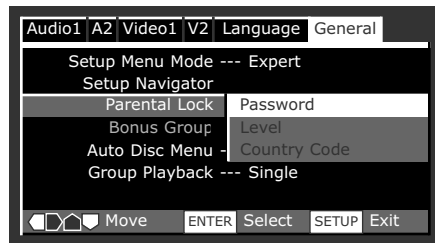
"Other" Language Screens



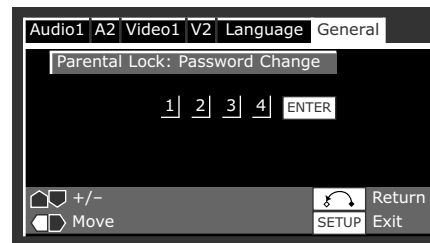
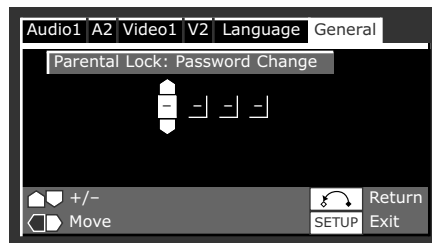
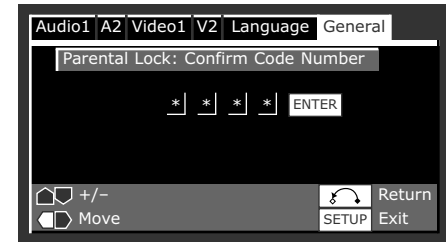
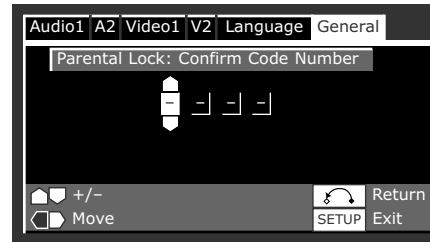
General Tab



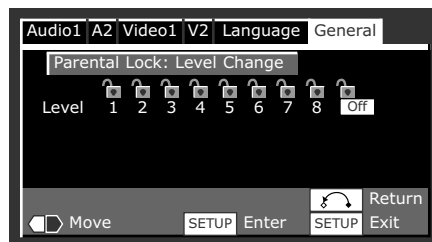
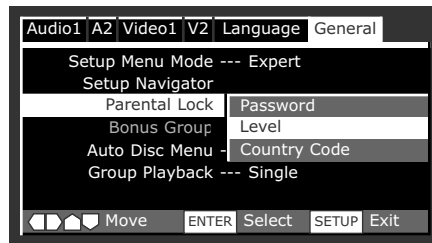
**Parental Lock:
Password Screens**



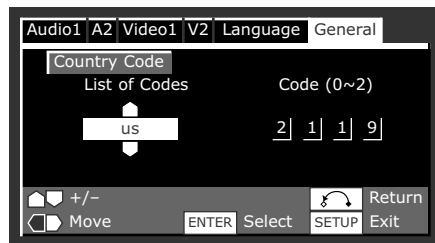
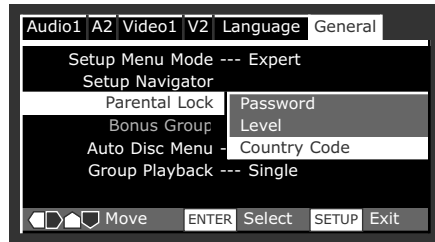
**Parental Lock:
Password Change
Screens**



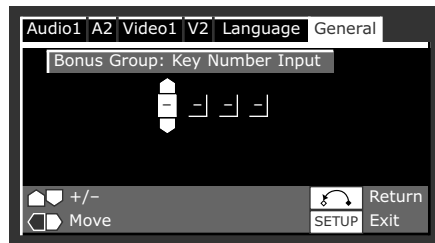
**Parental Lock: Level
Screens**



**Parental Lock:
Country Code
Screens**



**Bonus Group
Screens**



**Function Memory
Menu**

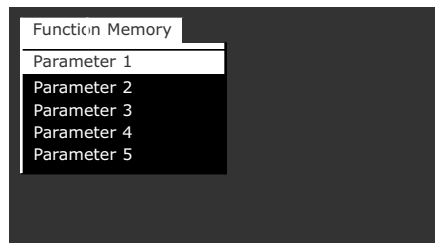


TABLE OF LANGUAGES & LANGUAGE CODES

Language	Numeric Code	Abb.	Language	Numeric Code	Abb.	Language	Numeric Code	Abb.
English (Anglais)	0514	en	Bislama	0209	bi	Hausa	0801	ha
French	0618	fr	Bengali	0214	bn	Hindi	0809	hi
German	0405	de	Tibetan	0215	bo	Croatian	0818	hr
Italian	0920	it	Breton	0218	br	Hungarian	0821	hu
Japanese (Japonais)	1001	ja	Catalan	0301	ca	Armenian	0825	hy
Spanish	0519	es	Corsican	0315	co	Interlingua	0901	ia
Dutch	1412	nl	Czech	0319	cs	Interlingue	0905	ie
Russian	1821	ru	Welsh	0325	cy	Inupiak	0911	ik
Chinese	2608	zh	Danish	0401	da	Indonesian	0914	in
Korean	1115	ko	Bhutani	0426	dz	Icelandic	0919	is
Greek	0512	el	Esperanto	0515	eo	Hebrew	0923	iw
Afar	0101	aa	Estonian	0520	et	Yiddish	1009	ji
Abkhazian	0102	ab	Basque	0521	eu	Javanese	1023	jw
Afrikaans	0106	af	Persian	0601	fa	Georgian	1101	ka
Amharic	0113	am	Finnish	0609	fi	Kazakh	1111	kk
Arabic	0118	ar	Fiji	0610	fj	Greenlandic	1112	kl
Assamese	0119	as	Faroese	0615	fo	Cambodian	1113	km
Aymara	0125	ay	Frisian	0625	fy	Kannada	1114	kn
Azerbaijani	0126	az	Irish	0701	ga	Kashmiri	1119	ks
Bashkir	0201	ba	Scots-Gaelic	0704	gd	Kurdish	1121	ku
Byelorussian	0205	be	Galician	0712	gl	Kirghiz	1125	ky
Bulgarian	0207	bg	Guarani	0714	gn	Latin	1201	la
Bihari	0208	bh	Gujarati	0721	gu	Lingala	1214	ln

Language	Numeric Code	Abb.
Laothian	1215	lo
Lithuanian	1220	lt
Latvian	1222	lv
Malagasy	1307	mg
Maori	1309	mi
Macedonian	1311	mk
Malayalam	1312	ml
Mongolian	1314	mn
Moldavian	1315	mo
Marathi	1318	mr
Malay	1319	ms
Maltese	1320	mt
Burmese	1325	my
Nauru	1401	na
Nepali	1405	ne
Norwegian	1415	no
Occitan	1503	oc
Oromo	1513	om
Oriya	1518	or
Panjabi	1601	pa
Polish	1612	pl
Pashto, Pushto	1619	ps
Portuguese	1620	pt

Language	Numeric Code	Abb.
Quechua	1721	qu
Rhaeto-Romance	1813	rm
Kirundi	1814	rn
Romanian	1815	ro
Kinyarwanda	1823	rw
Sanskrit	1901	sa
Sindhi	1904	sd
Sangho	1907	sg
Serbo-Croatian	1908	sh
Singhalese	1909	si
Slovak	1911	sk
Slovenian	1912	sl
Samoan	1913	sm
Shona	1914	sn
Somali	1915	so
Albanian	1917	sq
Serbian	1918	sr
Siswati	1919	ss
Sesotho	1920	st
Sundanese	1921	su
Swedish	1922	sv
Swahili	1923	sw

Language	Numeric Code	Abb.
Tamil	2001	ta
Telugu	2005	te
Tajik	2007	tg
Thai	2008	th
Tigrinya	2009	ti
Turkmen	2011	tk
Tagalog	2012	tl
Setswana	2014	tn
Tonga	2015	to
Turkish	2018	tr
Tsonga	2019	ts
Tatar	2020	tt
Twi	2023	tw
Ukrainian	2111	uk
Urdu	2118	ur
Uzbek	2126	uz
Vietnamese	2209	vi
Volapük	2215	vo
Wolof	2315	wo
Xhosa	2408	xh
Yoruba	2515	yo
Zulu	2621	zu

TABLE OF COUNTRY CODES

Country	Numeric Code	Abb.
Argentina	0118	ar
Australia	0121	au
Austria	0120	at
Belgium	0205	be
Brazil	0218	br
Canada	0301	ca
Chile	0312	cl
China	0314	cn
Denmark	0411	dk
Finland	0609	fi
France	0618	fr
Germany	0405	de

Country	Numeric Code	Abb.
Hong Kong	0811	hk
India	0914	in
Indonesia	0904	id
Italy	0920	it
Japan	1016	jp
Korea, Republic of	1118	kr
Malaysia	1325	my
Mexico	1324	mx
Netherlands	1412	nl
New Zealand	1426	nz
Norway	1415	no
Pakistan	1611	pk

Country	Numeric Code	Abb.
Philippines	1608	ph
Portugal	1620	pt
Russian Federation	1821	ru
Singapore	1907	sg
Spain	0519	es
Switzerland	0308	ch
Sweden	1905	se
Taiwan	2023	tw
Thailand	2008	th
United Kingdom	0702	gb
United States	2119	us

INSTALLATION WORKSHEET

Setup Navigator	Setting
Setup Navigator	
OSD Language	
TV Type	
Analog Jacks	
Center Speaker	
Surround Speakers	
Sub-woofer	
Digital Jack	
96kHz PCM Audio	
Exit Setup Navigator	

Audio1	Setting
Audio DRC	
Dolby Digital Out	
DTS Out	
Linear PCM Out	
MPEG Out	
Digital Out	
SACD Playback	

Audio2	Setting
Audio DRC	
Speaker Setting*	
Gain Setting*	
CD Digital Direct	

* Refer below for Speaker Setting & Gain Setting.

Speaker Setting & Gain Setting	Speaker Size	Speaker Distance	Output Level	Test Tone
L/R (Front Left/Right)	Large			
C (Center)				
LS (Surround Left)				
RS (Surround Right)				
SW (Subwoofer)				

Installation Worksheet (continued from page A-17)

Video1	Setting
TV Screen	
Component Video	
Video Out	
S-Video Out	
Frame Search	
Screen Saver	

Video2	Setting
Background	
Video Adjust*	
Still Playback	
On Screen Display	
Angle Indicator	

* Refer to the next column for Video Adjust.

Video Adjust	Setting
PureCinema	
YNR	
CNR	
MNR	
BNR	
Sharpness High	
Sharpness Mid	
Detail	
White Level	
Black Level	
Black Setup	
Gamma	
Hue	
Chroma Level	
Chroma Delay	
Memory	
Prog. Motion	

Language	Setting
OSD Language	
Audio Language	
Subtitle Language	
Auto Language	
DVD Language	
Subtitle Display	
Subtitle Off	

General	Setting
Setup Menu Mode	
Setup Navigator*	
Parental Lock	
Bonus Group	
Auto Disc Menu	
Group Playback	

* Refer to page A-17 for Setup Navigator.

Index

SYMBOLS

- ▲ Arrow, 2-16, 3-2, 3-4, 3-9, 3-52, 4-6, 4-22
- ▼ Arrow, 2-16, 3-2, 3-4, 3-9, 3-52, 4-6, 4-22
- ◀ Arrow, 2-16, 3-2, 3-4, 3-9, 4-6, 4-22
- ◀◀, 2-5, 2-17, 4-16
- ◀◀◀, 2-17, 4-6, 4-18, 4-19, 4-21
- ◀◀/◀◀, 2-5, 2-17
- ▶
 - Arrow, 2-16, 3-2, 3-9, 4-6, 4-22
 - Button, 2-4, 2-16, 4-11
 - Indicator, 2-7
- ▶▶, 2-5, 2-17, 4-16
- ▶▶▶, 2-17, 4-6, 4-18, 4-19, 4-21
- ▶▶/▶▶, 2-5, 2-17
- - Button, 2-4, 2-18, 3-53, 4-15, 4-16, 4-17, 4-22
 - Indicator, 2-7
- Button, 2-4, 2-16, 3-53, 4-14, 4-17, 4-19, 4-21, 5-16
- ⊗ Indicator, 2-6
- Ⓞ Indicator, 2-8, 2-14
- 🗑️ Indicator, 2-7, 3-35, 4-9
- ↶ Indicator, 2-7
- 🚫 Icon, 3-50, 4-2, 4-11
- 🚫 Icon, 3-50, 4-2
- ✓_P Icon, 4-27, 5-4
- ⚠️, iii, vi to x
- ⚠️, iii, vi to x

NUMBERS

- +10 Button, 2-15, 4-5, 4-22, 4-29, 5-3
- 1 Button, 2-15, 4-5, 4-22, 3-53

NUMBERS *(continued)*

- 192kHz Indicator, 2-7
- 2 Button, 2-15, 4-5, 4-22, 3-53
- 3 Button, 2-15, 4-5, 4-22
- 4 Button, 2-15, 4-5, 4-22
- 5 Button, 2-15, 4-5, 4-22
- 5.1 CH Indicator, 2-7
- 6 Button, 2-15, 4-5, 4-22
- 7 Button, 2-15, 4-5, 4-22
- 8 Button, 2-15, 4-5, 4-22
- 9 Button, 2-15, 4-5, 4-22
- 96kHz Indicator, 2-7
- PCM Audio Prompt, 3-3, 3-8, 3-14

A

A-B

- Button, 2-18, 4-19, 4-21, 4-22
- Repeat Playback, 2-18, 4-12, 4-19, 4-21 to 4-22
- About the RT-10, 1-2 to 1-3
- AC Input Connector, 2-8
- Advanced Setup Menu, 2-3, 2-16, 3-51 to 3-53, 4-10, 5-12

Analog

- Audio Output, 2-8, 2-10, 2-11, 2-13, 3-5, 3-6, 3-7, 3-16, 3-17, 3-18, 3-19, 3-20, 3-21, 3-22, A-2
- Jacks Prompt, 3-3, 3-5 to 3-6, 3-16, 3-23

Angle(s)

- Button, 2-18, 3-35, 4-6, 4-9, 5-13
- Indicator Parameter, 3-29, 3-35, 4-9
- Selecting Camera, 2-18, 4-9, 5-13
- Arrows, Remote Control, 2-16, 3-2, 3-4, 3-9, 3-52, 4-6, 4-22

- Aspect Ratio, 3-5, 3-25 to 3-26

Audio

- 1 Tab, 3-11 to 3-15, A-6 (*ills.*)
- 2 Tab, 3-15 to 3-24, A-6 (*ills.*), A-7 (*ills.*)
- Button, 2-18, 3-37, 4-6, 4-7, 4-8

A *(continued)*

Audio

- DRC Parameter, 3-11, 3-12
- Language Parameter, 3-36, 3-37, 3-39, 3-41, 3-50, 4-7
- Out Parameter, 2-7, 2-10, 2-13, 3-3, 3-16 to 3-17
- Output, 2-10, 2-11, 2-13, 5-4 to 5-7, A-2
- Performance Specifications, A-2
- Tracks, Selecting, 2-18, 4-7 to 4-8

Auto

- _P Parameter, 3-51, 3-52
- Disc Menu Parameter, 3-41, 3-49
- Language Parameter, 3-36, 3-39

B

- Background Parameter, 3-29
- Bandwidth, A-3
- Banks, Video Adjust, 3-34
- Basic Mode, Setup Menu, 3-9 to 3-10 (*ill.*), A-5 (*ill.*)
- Battery Installation, Remote Control, 1-9
- Black**
 - Level Parameter, 3-30, 3-31
 - Noise Reduction (BNR) Parameter, 3-30, 3-31
 - Setup Parameter, 3-30, 3-31
- BNR (Black Noise Reduction) Parameter, 3-30, 3-31
- Bonus Group Parameter, 3-41, 3-48, A-13 (screens)
- Bookmarks, 4-13

C

- C Parameter, 3-18, 3-22
- Camera Angle(s), *see* *Angle(s)*
 - , i, ii, iii, 1-3, 1-8, 2-3, 2-9, 4-2, 5-5, 5-16

CAUTION

- Digital Direct Parameter, 3-16, 3-24
- Documentation Convention, iii
- Center Speaker Prompt, 3-3, 3-6

... *Index continues on page I-2*

Index *(continued)*



C *(continued)*

- Channel Separation, A-2
- Channels Indicator, 2-8
- Character Display, 2-6
- CHP Indicator, 2-6
- Chroma**
 - Delay Parameter, 3-31, 3-32
 - Level Parameter, 3-31, 3-32
- Chrominance Noise Reduction (CNR) Parameter, 3-30, 3-31
- CLEAR Button, 2-15, 4-5, 4-17, 4-19, 4-21, 4-22
- CNR (Chrominance Noise Reduction) Parameter, 3-30, 3-31
- Command Matrix**
 - Disc Menu, 4-5 to 4-6
 - Remote Control, 2-14 to 2-18
- Command Modes**
 - Assigning Remote Control, 3-53
 - DVD_1, 3-53
 - DVD_2, 3-53
- Component Video**
 - Parameter, 3-24, 3-27
 - Output Connectors, 2-9 to 2-10, A-2
- Composite Video Output Connectors, 2-10, A-2
- COND Indicator, 2-7
- CONDITION MEMO Button, 2-18, 4-7, 4-10, 4-11
- Condition Memory Mode, 2-18, 4-7, 4-10 to 4-11
- Connections, Rear Panel, 2-11 to 2-13
- Control Bar, 3-2
- Country Code(s)**
 - Control, 3-42, 3-47, A-13 (screens), A-16
 - Table of, A-16



D

- OFF Indicator, 2-7
- D/A Conversion**
 - Audio Signals, A-2

D *(continued)*

- D/A Conversion**
 - Video Signals, A-3
- Declaration of Conformity, RT-10, A-3
- Detail Parameter, 3-30, 3-31
- Digital**
 - Audio Output Connectors, 2-10, 2-13, 3-17, A-2
 - Jack Prompt, 3-3, 3-7 to 3-8
 - Out Parameter, 3-11, 3-14
- Dimensions, RT-10, A-3
- DIMMER Button, 2-15
- Disc(s)**
 - to Avoid, 1-8
 - Care & Handling, 1-8
 - Compatibility, 1-5 to 1-7
 - Drawer, 2-3
 - Loading, 4-2 to 4-3
 - Maintenance, 5-16
 - Menus, Navigating, 4-3 to 4-6
 - Settings, Selecting, 4-7 to 4-11
 - Settings, Storing, 4-10 to 4-11
- DISP_MODE Parameter, 3-51, 3-52
- Display**
 - Button, 2-18, 4-30, 4-31, 4-36
 - Character, 2-6
 - Front Panel, 2-3, 2-6 to 2-8 (indicators)
 - Off Button, 2-3 to 2-4
 - Mode, 2-18, 4-12, 4-30 to 4-36
 - On-Screen, 5-4 (icons)
- Distances, Setting Speaker, 3-20 to 3-21
- Documentation Conventions, iii
-  Indicator, 2-6
- Dolby Digital Out Parameter, 3-3, 3-11, 3-12
- DOWN MIX, 2-7
-  Indicator, 2-6
- DTS Out Parameter, 3-3, 3-11, 3-13

D *(continued)*

- DVD**
 - Indicator, 2-6
 - Icon, 3-11
 - DVD**
 - Audio, iii, *see also DVD-A*
 - Documentation Convention, iii
 - Language Parameter, 3-36, 3-39 to 3-40, 3-50
 - Video, iii, *see also DVD-V*
 - DVD_1 Command Mode, 3-51, 3-53
 - DVD_2 Command Mode, 3-51, 3-53
 - DVD-A Connections, 2-11, 2-13
 -  Indicator, 2-6
 - DVD-RAM, 1-5
 - DVD-ROM, 1-5
 - DVD-V Region Codes, 1-4 (map), 2-8
 - Dynamic Range, A-2
- ## E
- ENTER Button, 2-16, 3-4, 3-9, 3-52, 4-5
 - Euro or Peritel (TV A/V) Output, 2-10, 2-12 to 2-13, 3-27, A-3
 - Exit Setup Navigator Prompt, 3-3, 3-9
 - Expert Mode, Setup Menu, 3-9 to 3-10 (*ill.*), A-5 (*ill.*)
- ## F
- Factory-Default Settings, Restoring, 5-16
 - F.MEMO Button, 2-18
 -  Icon, 3-50
 - Forward Skip/Scan Button, 2-5
 - Frame Search Parameter, 3-24, 3-28
 - Frame-by-Frame Playback, 2-5, 2-17, 4-12, 4-16
 - Frequency Response, A-2

F *(continued)*

Front Panel

- Display, 2-3, 2-6 (*ill.*) to 2-8 (indicators)
- Illustration, 2-2
- Overview, 2-2 to 2-5
- Function Memory Mode, 2-18, 3-50, A-12 (tab)

G

Gain Setting

- Parameter, 3-21 to 3-24
- Screens, A-7 (*ills.*)
- Gamma Parameter, 3-31, 3-32
- General Tab, 3-41 to 3-49, A-11 (*ills.*), A-12 (*ills.*), A-13 (*ills.*), A-14 (*ills.*)
- Group Playback Parameter, 3-41, 3-49
- GRP Indicator, 2-6

H

- Highlights, RT-10, 1-3
- Hue Parameter, 3-31, 3-32

I

- Icons, Playback, 4-2, 5-4
- Indicators, Front Panel Display, 2-6 to 2-8
- Inspection Instructions, Unpacking &, xi

Installation

- Considerations, 1-3 to 1-4
- Worksheet, A-17 to A-18
- IR IN Connector, 2-11, A-3

L

- L/R Parameter, 3-18, 3-22
- LAST Indicator, 2-7
- LAST MEMO Button, 2-18, 4-13
- Last Memory Playback, 2-18, 4-13
- Linear PCM Out Parameter, 3-11, 3-13 to 3-14

L *(continued)*

Language(s)

- Tab, 3-36 to 3-41, A-10 (*ills.*), A-14 to A-15
- Table of, A-14 to A-15
- Last Memory Playback, 4-12, 4-13
- Level Control, Security, 3-42, 3-45 to 3-46, A-12 (screens)
- Limited Warranty, Inside Back Cover
- Linear PCM Out Parameter, 3-3, 3-11, 3-13 to 3-14
- Loading Discs, 4-2 to 4-3
- LS Parameter, 3-18, 3-22
- Luminance Noise Reduction (YNR) Parameter, 3-30, 3-31

M

Maintenance

- Disc, 5-16
- RT-10, 5-15
- MC-12 Digital Controller, 2-11, 3-3, 3-7, 3-11, 3-16, 3-18, 3-22, 5-6, 5-10
- MC-8 Digital Controller, 2-11, 3-3, 3-7, 3-11, 3-16, 3-18, 3-22, 5-6, 5-10
- Memory Parameter, 3-31, 3-32 to 3-33
- MENU Button, 2-16, 4-5
- Menus, Navigating Disc, 4-3 to 4-6
- MNR (Mosquito Noise Reduction) Parameter, 3-30, 3-31
- Mosquito Noise Reduction (MNR) Parameter, 3-30, 3-31
- MP3 Navigator, 4-4 (*ill.*), 4-27 (*ill.*)
- MPEG Out Parameter, 3-3, 3-11, 3-14

N

- Navigating Disc Menus, 4-3 to 4-6
- NEXT Button, 2-17, 4-6, 4-18, 4-19, 4-21
- Number Buttons, Remote Control, 2-15, 4-5, 4-22, 3-53

O

- On/Off Button, 2-2
- On Screen Display Parameter, 3-29, 3-35
- Open/Close Button, 2-3, 2-15
- Operating Temperature, RT-10, A-3
- Operation Considerations, Remote Control, 2-14

OSD Language

- Parameter, 3-3, 3-36
- Prompt, 3-3, 3-4
- Output Impedance, Video, A-3

Output Level(s)

- Audio Specifications, A-2
- Setting Variable, 3-21 to 3-23
- Video Specifications, A-3

P

- Parental Lock Controls, 3-41, 3-42 to 3-47, A-11 to A-13 (screens.)
- Password Control, 3-42 to 3-45, A-11 to A-12 (screens.)
- Pause**
 - Button, 2-4, 2-18, 3-53, 4-15, 4-16, 4-17, 4-22
 - Mode, 2-4, 2-5, 2-7, 2-17, 2-18, 4-12, 4-15, 4-16
- Peritel or Euro (TV A/V) Output, 2-10, 2-12 to 2-13, 3-27, A-3

Playback

- Icons, 4-2
- Mode, 4-11, 4-12
- Modes, 4-11 to 4-36
- Troubleshooting, 5-7 to 5-9, 5-12 to 5-15

Power

- Button, 2-15
- Consumption, A-3
- Requirements, A-3
- PREV Button, 2-17, 4-6, 4-18, 4-19, 4-21

. . . Index continues on page I-4

Index_(continued)

P _(continued)

Product Registration, 1-3
Prog. Motion Parameter, 3-31, 3-34

Program

Button, 2-16, 4-5, 4-17, 4-22, 4-23, 4-24, 4-25, 4-26, 4-27
Memory Parameter, 4-23, 4-24, 4-25,
Mode, 2-16, 4-12, 4-22 to 4-28

 Indicator, 2-7

Progressive-Scan Component Video Output, 2-7, 2-10, 2-12, 3-27

Pure Cinema Parameter, 3-30, 3-31

R

Rack Mounting, A-3

Random

Button, 2-18, 4-17, 4-18, 4-19, 4-21
Playback, 2-18, 4-12, 4-17 to 4-18

Rear Panel

Connections, 2-11 to 2-13
Overview, 2-8 to 2-13
Illustration, 2-9
Region Code Indicator, 2-8


Region Codes, 1-4 (map), 2-8

Registration, Product, 1-3

REMAIN Indicator, 2-7

REMOT_CODE Parameter, 3-51, 3-53

Remote Control

, 2-8, 2-14
Battery Installation, 1-9
Command Matrix, 2-14 to 2-18
Command Modes, Assigning, 3-53
Disc Menu Command Matrix, 4-5 to 4-6
Illustrations, 1-9, 2-15, 2-16, 2-17, 2-18
Operation Considerations, 2-14
Overview, 2-14 to 2-18
Troubleshooting, 5-2

R _(continued)

Repeat

Button, 2-18, 4-17, 4-19, 4-20, 4-21
Playback, 2-18, 4-12, 4-19 to 4-20

Resume Mode, 2-4, 2-16, 4-14

RETURN Button, 2-16, 3-4, 3-9, 4-5

Reverse Skip/Scan Button, 2-5

RS Parameter, 3-18, 3-22

RT-10

About the, 1-2 to 1-3
Declaration of Conformity, A-3
Dimensions, A-3
Highlights, 1-3
Maintenance, 5-15
Operating Temperature, A-3
Specifications, A-2 to A-3
Weight, A-3

S

S-video

Out Parameter, 3-24, 3-28
Output Connectors, 2-10, A-2

SACD

Connections, 2-13
Playback Parameter, 3-11, 3-15

Safety Instructions, inside front cover, i, ii, iii, vi to x

Sample Rate Indicator, 2-7

Screen Saver Parameter, 3-24, 3-28

Search

Button, 2-16, 4-6, 4-28, 4-29
Mode, 2-16, 4-12, 4-28 to 4-30

Security Level Control, 3-42, 3-45 to 3-46

Selecting Disc Settings, 4-7 to 4-11

SETUP Button, 2-15, 3-4, 3-9, 3-52

Setup Menu

Mode Parameter, 3-9 to 3-10
Overview, 3-9 to 3-49

S _(continued)

Setup Menu

Screens, A-4 to A-13 (*ills.*)
Shortcuts, 3-50
Troubleshooting, 5-9 to 5-12

Setup Navigator

Overview, 3-2 to 3-9
Prompt, 3-3, 3-4
Prompts, 3-3 to 3-9

Sharpness

Mid Parameter, 3-30, 3-31
High Parameter, 3-30, 3-31

Signal-to-Noise Ratio

Audio Signals, A-2
Video Signals, A-3

Sizes, Setting Speaker, 3-19 to 3-20

Slow Playback, 2-5, 2-17, 4-12, 4-16 to 4-17

Speaker

Distances, Setting, 3-20 to 3-21
Setting Parameter, 3-3, 3-16, 3-18 to 3-21
Setting Screens, A-7 (*ills.*)
Sizes, Setting, 3-19 to 3-20

Specifications, A-2 to A-3

Standby

LED, 2-2 to 2-3
Mode, 2-2 to 2-3, 2-10, 2-11, 2-15, 3-52, 5-2
Still Frame Playback, 4-12, 4-15
Still Picture Parameter, 3-29, 3-35

Stop

Button, 2-4, 2-16, 3-53, 4-14, 4-17, 4-19, 4-21, 5-16
Mode, 2-4, 2-16, 4-12, 4-14

Subtitle

Button, 2-18, 4-6, 4-8
Display Parameter, 3-36, 3-40 to 3-41
Language Parameter, 3-36, 3-38 to 3-39
Languages, Selecting, 2-18, 4-8
Off Parameter, 3-36, 3-41

S *(continued)*

Sub-woofer Prompt, 3-3, 3-7
Surround Speakers Prompt, 3-3, 3-6
SW Parameter, 3-18, 3-22

T

Table of Contents, iv to v
THD + Noise, A-2
Test Tones, Activating, 3-22, 3-23

TITLE Indicator, 2-6

TOTAL Indicator, 2-7

TOP MENU Button, 2-16, 4-5

Trigger Input

Connector, 2-11
Control, 2-11
Input Switch, 2-10 to 2-11

TRK Indicator, 2-7

Troubleshooting, 5-2 to 5-15

TV

Output Connector, 2-10, 2-12 to 2-13, 3-27, A-3
Screen Parameter, 3-3, 3-24, 3-25 to 3-26
Type Prompt, 3-3, 3-5

U

Unpacking & Inspection Instructions, xi

V

V OFF Indicator, 2-7

V-PART Indicator, 2-7

Variable Output Levels, Setting, 3-21 to 3-23

VCD Indicator, 2-6

Video

1 Tab, 3-24 to 3-28, A-8 *(ills.)*
2 Tab, 3-29 to 3-35, A-8 *(ills.)*, A-9 *(ills.)*
ADJ. Button, 2-18

V *(continued)*

Video

Connections, 2-11 to 2-12
ON/OFF Button, 2-15
Out Parameter, 3-24, 3-27
Output, 2-9 to 2-10, 2-11 to 2-13, 5-3 to 5-4, A-2
Output Impedance, A-3
Performance Specifications, A-3

W

WARNING, i, iii

Warranty, Limited, inside back cover

White Level Parameter, 3-30, 3-31

Weight, RT-10, A-3

Y

YNR (Luminance Noise Reduction) Parameter, 3-30,
3-31

LIMITED WARRANTY

Lexicon, Inc. offers the following warranty on this product:

What is the Duration of this Warranty?

This warranty will remain in effect for one (1) year from the original date of purchase.

Who is Covered?

This warranty may be enforced by the original purchaser and subsequent owners during the warranty period, provided the original dated sales receipt or other proof of warranty coverage is presented at time of service.

What is Covered?

This warranty covers all defects in material and workmanship on this product, except as specified below. The following are not covered:

1. Damage resulting from
 - A. Accident, misuse, abuse, or neglect.
 - B. Failure to follow instructions contained in the user guide.
 - C. Repair or attempted repair unauthorized by Lexicon, Inc.
 - D. Failure to perform recommended periodic maintenance.
 - E. Causes other than product defects, including lack of skill, competence, or experience on the part of the owner.

2. Damage occurring during any shipment of this product. Claims for shipping damages must be made with the carrier.
3. Damage to a unit that has been altered, or on which the serial number has been defaced, modified, or removed.

What Expenses will Lexicon, Inc. Assume?

Lexicon, Inc. will pay all labor and material expenses for covered items. Payment of shipping charges is discussed in the next section of the warranty.

How is Service Obtained?

When this product needs service, write, telephone, or fax Lexicon, Inc. to request information about where the unit should be taken or sent. When making a written request, please include your name, complete address, and daytime telephone number; the product model and serial numbers; and a description of the problem. Do not return the unit to Lexicon, Inc. without prior authorization.

When Shipping a Product for Service . . .

1. Pay any initial shipping charges, which are the responsibility of the owner. If necessary repairs are covered by this warranty, Lexicon, Inc. will pay return shipping charges to any destination in the United States using the carrier of our choice.
2. Pack the unit securely. Package insurance is strongly recommended.

3. Include a copy of the original dated sales receipt. (A copy of the original dated sales receipt must be presented whenever warranty service is required.)
4. Do not include accessories such as power cords or user guides unless instructed to do so.

What are the Limitations of Implied Warranties?

Any implied warranties, including warranties of merchantability and fitness for a particular purpose, are limited in duration to the length of this warranty.

What Certain Damages are Excluded?

Lexicon's liability for a defective product is limited to repair or replacement of that product, at our option. Lexicon, Inc. shall not be liable for damages based on inconvenience; loss of use of the product; loss of time; interrupted operation; commercial loss; or any other damages, whether incidental, consequential, or otherwise.

How do State Laws Relate to this Warranty?

Some states do not allow limitations on the duration of implied warranties and/or the exclusion or limitation of incidental or consequential damages. As such, the above limitations may not apply.

This warranty is not enforceable outside of North America. This warranty provides specific legal rights. Additional rights may be provided by some states.



Lexicon, Inc.
3 Oak Park
Bedford, MA 01730-1413
USA

Tel 781-280-0300
Fax 781-280-0490
www.lexicon.com

Customer Support
Tel 781-280-0300
Fax 781-280-0495 (Sales)
Fax 781-280-0499 (Service)



Lexicon, Inc.
3 Oak Park
Bedford, MA 01730-1413 USA
Tel 781-280-0300
Fax 781-280-0490
www.lexicon.com

Customer Support
Tel 781-280-0300
Fax 781-280-0495 (Sales)
Fax 781-280-0499 (Service)