

naim

100 POL 00

input

mode

DOLBY
DIGITAL

DIGITAL
DTS
SURROUND

OWNERS MANUAL
AV System

Introduction

Naim Audio products are always conceived with performance as the top priority and careful installation will help ensure that their full potential is achieved. This manual begins with general installation tips for all Naim Audio products, and statutory safety warnings. Product specific information begins in Section 5.

1.0 Equipment installation

Normally your Naim equipment will have been installed by the dealer who sold it to you even if you live outside their immediate vicinity. Your dealer is responsible for making sure that the system sounds exactly as it should and information given here is not intended to reduce this responsibility in any way.

1.1 cables and connections

Please do not modify the standard interconnect cables supplied with your Naim equipment. This is important for safety as well as performance. One end of each cable is marked with a band to establish its correct orientation. The band always marks the end that connects to the signal source.

Loudspeaker leads are also very important. Naim loudspeaker cable is correct for your system and your dealer will make up leads to suit your equipment installation. **The leads should each be at least 3.5 metres long and of equal length.** The recommended maximum is 20 metres. Loudspeaker leads are, like interconnect leads, directional, and should be connected so that the printed arrow points towards the speakers. Using alternative loudspeaker cable will degrade performance, and may even damage your amplifier. An exception to these loudspeaker cable constraints is the **nap 6-50** multi-room power amplifier. The **nap 6-50** is designed to be tolerant of both a wide variety of cable types, and cable runs well in excess of 20m. The loudspeaker connectors supplied with all Naim amplifiers and loudspeakers have been specifically designed to make a robust mechanical connection. It is essential that these are used in order to comply with current European safety regulations.

All the plugs and sockets supplied with your Naim equipment have been chosen because they make the best possible connection for their purpose. A poor contact will degrade the signal substantially and plugs and sockets should look clean and free from corrosion. The easiest way to clean them is to switch off the equipment, pull the plugs out of their sockets, and push them back in again. Special contact cleaners and contact enhancers should not be used as they tend to deposit a film which is very difficult to remove and may degrade the sound.

page	
1	1.0 Equipment Installation
	1.1 cables and connections
2	2.0 Getting Started
	2.1 switching on and off
	2.2 running in
	2.3 mains supply
	2.4 siting the equipment
	2.5 if you have a problem
3	3.0 Warnings
4	4.0 Connection
	4.1 mains lead
	4.2 non-rewireable mains plugs
	4.3 fuse carrier
	4.4 plug fuses
5	5.0 product introduction
6	6.0 av2 basics and quick setup
8	7.0 av2 inputs and interfaces
9	8.0 av2 outputs and interfaces
10	9.0 av2 detailed setup
16	10.0 av2 operation
22	11.0 av2 setup defaults
23	12.0 av2 connection diagrams
26	13.0 nap v175 installation and operation
27	14.0 nap v175 connection diagram
28	EC Declaration of Conformity Licence Declarations

2

2.0 Getting Started

2.1 switching on and off

Source components and power supplies for cd players, tuners, preamplifiers and crossovers should be switched on before switching on the amplifier(s). Always switch the amplifier(s) off and wait about a minute for the power supply capacitors to discharge before connecting or disconnecting any leads. Always use the power switch on the product rather than a mains outlet switch.

2.2 running in

Your Naim equipment will take a considerable time to run-in before it performs at its best. The duration varies, but under some conditions you will find that the sound continues to improve for as much as five weeks. Better and more consistent performance will be achieved if the system is left switched on for long periods. It is worth remembering however that all electronic equipment can be damaged by lightning. Please read the warnings section.

2.3 mains supply

Where fused plugs are used 13 amp fuses should be fitted. Fuses of a lower rating will fail after a period of use.

A hi-fi system usually shares a mains circuit with other household equipment some of which can cause distortion of the mains waveform. In some Naim equipment such distortion can lead to a mechanical hum from the transformers. The hum is not transmitted through the speakers and has no effect on the performance of the system but is purely local to the transformer itself. A separate fused mains circuit (like that reserved for electric cookers) may reduce transformer hum. Such a circuit (ideally with a 30 or 45 Amp rating) will also have a lower impedance, supply cleaner power, and consequently improve system performance.

Do not wire voltage dependent resistors or noise suppressors into mains plugs. They degrade the mains supply and the sound.

2.4 siting the equipment

Power supplies and amplifiers should be located a reasonable distance away from other equipment. This separation will stop transformer radiation causing hum audible from the loudspeakers. The minimum recommended distance is 300mm (12 inches), and that allowed by the standard interconnect lead is the maximum.

Some Naim equipment is extremely heavy. Ensure that your equipment rack or table can easily support the weight and is stable.

2.5 if you have a problem

Legal consumer protection varies from country to country. In most territories a dealer must be prepared to take back any Naim equipment he has sold you if he cannot make it work to your satisfaction in your own home. A problem may be due to a fault in any part of the system or its installation so it is essential to make full use of your local dealer's diagnostic skills on site. Please contact your local distributor, or Naim at the address in the back of this manual, if any difficulties cannot be resolved. Some Naim equipment is made in special versions for different territories and this makes it impracticable to arrange international guarantees. Please establish the guarantee arrangements with your own dealer at the time of sale. We are always available to offer help and advice.

It is essential that repairs and updates are only carried out by an authorised Naim dealer, or at the factory by Naim itself. Many components are made, tested or matched specially for Naim and appropriate replacements are often unobtainable from non-specialist sources.

3.0 Warnings

Naim equipment is designed to offer the finest sound quality that can be achieved avoiding compromise wherever possible. This can lead to circumstances that may be unfamiliar. The material that follows contains advice specifically related to Naim equipment as well as more general warnings about the use of domestic audio products. Please read it carefully.

The transformers in Naim power amplifiers and power supplies may sometimes make a mechanical noise caused by distortion of the mains waveform. Naim transformers are large in size and have heavy gauge secondary windings making them relatively sensitive to such distortion. A separate mains circuit for your hi-fi system may reduce the effect while also giving an overall improvement in sound quality. It may be necessary however to take account of mechanical transformer noise when siting your equipment.

In some circumstances, depending on where you live and the earthing arrangements in your home, you may experience radio frequency interference. Controls on broadcasting in some territories allow very high levels of radio frequency radiation and both the choice and exact siting of equipment may be critical. If there is a known problem in your locality it is advisable to arrange for a home demonstration before purchase to find out if Naim equipment is likely to be affected. Susceptibility to radio frequency interference is related to the wide internal bandwidth necessary for high sound quality. Systems incorporating moving coil phono preamplifiers and active crossovers are more likely to suffer. A radio frequency filter kit is available for some Naim equipment but sound quality will be progressively compromised as more elements of the kit are fitted. In situations of extreme radio interference Naim equipment may be unsuitable.

Your Naim hi-fi system can be damaged by lightning. Power amplifiers are particularly at risk and should be turned off when there is risk of lightning strike. For complete protection all mains plugs and any aerial cables should be disconnected when not in use.

Equipment must not be exposed to dripping or splashing and no objects filled with liquid, such as vases, should be placed on the equipment.



important

In order to comply with current European safety regulations it is essential that the Naim loudspeaker connectors supplied with amplifiers and loudspeakers are used.

Do not under any circumstances allow anyone to modify your Naim equipment without first checking with the factory, your dealer, or your distributor. Unauthorised modifications will invalidate your guarantee.

For your own safety do not under any circumstances open Naim equipment without first disconnecting the mains.

The following label is attached to all mains powered equipment:



4.0 Connection

4.1 mains lead

As the colours of the wires in the mains lead of this apparatus may not correspond with the coloured markings identifying the terminals in your plug proceed as follows:

The wire which is coloured **GREEN-AND-YELLOW** must be connected to the terminal in the plug which is marked by the letter E or by the safety earth symbol or coloured green or green-and-yellow.

The wire which is coloured **BLUE** must be connected to the terminal in the plug which is marked with the letter N or coloured black.

The wire which is coloured **BROWN** must be connected to the terminal in the plug which is marked with the letter L or coloured red.

4.2 non-rewireable mains plugs

If a non-rewireable plug is cut from a mains lead (for whatever purpose) the plug **MUST** be disposed of in a way to render it totally unusable. Considerable shock hazard exists if the cut-off plug is inserted into a mains outlet.

4.3 fuse carrier

Should the plug fuse carrier be damaged or lost, the correct replacement must be obtained from your dealer or from Naim direct. Do not use the plug until the fuse carrier is replaced.

4.4 plug fuses

Replace only with ASTA or BS 1362 approved fuses.

note



This equipment has been tested and found to comply with the relevant EMC and Safety Standards, and, where applicable, also complies with the limits for a class B digital device, pursuant to Part 15 of the FCC Rules.

These limits are designed to provide reasonable protection against harmful interference in a residential installation. This equipment generates, uses and can radiate radio frequency and, if not installed and used in accordance with the instructions, may cause harmful interference to radio communications. However, there is no guarantee that interference will not occur in a particular installation. If this equipment does cause harmful interference to radio or television reception, which can be determined by turning off and on, the user is encouraged to try to correct the interference by one or more of the following measures:

- Reorient or relocate the receiving antenna.
- Increase the separation between the equipment and the receiver.
- Connect the equipment into an outlet on a circuit different from that to which the receiver is connected.
- Consult your Naim dealer or an experienced radio/TV technician for help.

5.0 product introduction

This manual covers the installation and use of the **av2** audio-visual processor and the **nap v175** three-channel power amplifier. Together these two components can add comprehensive audio-visual capabilities to any Naim system.

The **av2** is an audio processor for Dolby* Digital, Dolby Surround and DTS Digital Surround™ encoded programme material. It is designed to decode and control audio signals in multi-channel home theatre systems and to interface between an audio-visual system and a conventional two channel audio system.

The **av2** is fundamentally straightforward in use. However, its comprehensive functions and setup flexibility mean that a little time spent reading this manual will help ensure problem-free installation and use.

The **nap v175** is a three channel power amplifier intended to drive a centre channel speaker and a pair of either main front or surround channel speakers.

Following this product introduction, the manual is divided into the following sections:

6 **av2 basics and quick setup.**

This section provides an introduction to the basics of setting-up the **av2**. For those already familiar with the functions and operation of audio-visual processors the section provides a diagram-based short-cut through the **av2** setup routines.

7 **av2 inputs and interfaces.**

This section describes the signal input capabilities, input sockets and interface sockets of the **av2**.

8 **av2 outputs and interfaces.**

This section describes the signal output capabilities, output sockets and interface sockets of the **av2**.

9 **av2 detailed setup.**

This section describes the setup of the **av2** including use of the **narcom av** remote handset.

10 **av2 operation.**

This section describes the operation of the **av2** including use of the **narcom av** remote handset.

11 **av2 setup defaults.**

This section illustrates the default **av2** setup parameters.

12 **av2 connection diagrams.**

This section contains an illustration of the **av2** connection panel, and diagrams illustrating integration of the **av2** into both conventional and dedicated audio-visual systems.

13 **nap v175 installation and operation.**

This section describes the installation and operation of the **nap v175**.

14 **nap v175 connection diagram.**

This section contains an illustration of the **nap v175** connection panel.

note

* Dolby is a trademark of Dolby Laboratories.

“DTS”, “DTS-ES Extended Surround” and “Neo:6” are trademarks of Digital Theater Systems Inc.

6.0 av2 basics and quick setup

Installation of the av2 requires two setup routines to be carried out - **input setup** and **speaker setup**. These routines configure the av2 for the source equipment and loudspeakers it is to be used with and specify some signal decoding options. Some setup parameters are dependent on the state in which the av2 was last shut down so setup may be simplified if the av2 is returned to its setup defaults. See Section 11 for notes on restoring setup defaults. Information on av2 decode modes and capabilities can be found starting in Sections 10.2 - 10.6

The following diagrams provide a short-cut through the setup routines. They can also be used in conjunction with the detailed notes in Sections 9 and 10 where setup choices display legends are more fully explained.

6.1 switching on and off

on Wake av2 from standby (power switch on).
 Handset: press and hold standby.
 Front panel: press and hold input or mode.

off Put av2 to sleep (power switch on).
 Handset: press and hold standby.
 Front panel: press both input and mode.

6.2 input setup routine

one Enter setup mode.
 Handset: press menu followed by i/p ▲.
 Front panel: press and hold input.

two Scroll up or down parameter list.
 Handset: press 2 ▲ or 8 ▼
 Front panel: press input or mode.

three Adjust setting
 Handset: press ◀ 4 or 6 ▶
 Front panel: rotate rotary control

setup parameters	parameter settings
versatile analog input 1 (select source, multi)	V11 → BCH...AN1...SCD
versatile analog input 2 (select source, multi)	V12 → ---...AN2...SCD
analog input 3 (select source)	AN3 → ---...AN3...SCD
analog input 4 (select source)	AN4 → ---...AN4...SCD
analog input 5 (select source)	AN5 → ---...AN5...SCD
analog input 6 (select source)	AN6 → ---...AN6...SCD
optical digital input 1 (select source)	OP1 → ---...OP1...SCD
optical digital input 2 (select source)	OP2 → ---...OP2...SCD
coaxial digital input 1 (select source)	CO1 → ---...CO1...SCD
coaxial digital input 2 (select source)	CO2 → ---...CO2...SCD
remote control	EXT → RCS DAT
Dolby Surround Pro Logic II "Panorama"	PAN → OFF ON
Dolby Surround Pro Logic II "Centre Width"	W → 00 - 07
Dolby Surround Pro Logic II "Dimension"	D → 00 - 06

note
 Analog inputs 1 and 2 can be combined to provide one 8 channel or 6 channel input. In either case input 2 is then unavailable. For a complete description of this facility see Sections 7 and 9.

note
 With DAT (data) selected for the EXT parameter RC5 (remote handset) control is disabled. RC5 can be re-enabled using the front panel controls.

note
 The final three stages of the input setup routine provide adjustment for three Dolby Surround Pro Logic II music programme decode parameters. It is not necessary to set these parameters initially. See Section 9 for detailed information on these decode parameters.

four Exit setup mode.
 Handset: press menu followed by i/p ▲.
 Front panel: press and hold input.

6.0 av2 basics and quick setup

6.3 speaker setup routine

one Enter setup mode.

Handset: press menu followed by mode ▲ .
Front panel: press and hold mode.



two Scroll up or down parameter list.

Handset: press 2 ▲ or 8 ▼
Front panel: press input or mode.



three Adjust setting

Handset: press ◀ 4 or 6 ▶
Front panel: rotate rotary control

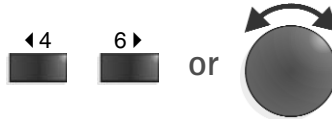

setup parameters	parameter settings
main speakers (size)	LR → LG SM
centre speaker (presence, size)	CEN → NO SM LG
surround speakers (presence, size)	SUR → NO SM LG
extra rear speakers (presence, quantity, size)	ER → NO 1SM 1LG 2SM 2LG
sub-woofer (presence)	SUB → NO YES
speaker distance units (feet, metres)	UNT → FT M
left main speaker (distance, ft or m)	L → 0 - 40 0 - 12.0
centre speaker (distance, ft or m)	CEN → 0 - 40 0 - 12.0
right main speaker (distance, ft or m)	R → 0 - 40 0 - 12.0
right surround speaker (distance, ft or m)	RS → 0 - 40 0 - 12.0
right extra rear speaker (distance, ft or m)	RR → 0 - 40 0 - 12.0
left extra rear speaker (distance, ft or m)	LR → 0 - 40 0 - 12.0
left surround speaker (distance, ft or m)	LS → 0 - 40 0 - 12.0
sub-woofer (distance, ft or m)	SUB → 0 - 40 0 - 12.0
test signal (off, on)	TST → OFF ON
main left speaker (level trim)	L → -30 - +30
centre speaker (level trim)	CEN → -30 - +30
main right speaker (level trim)	R → -30 - +30
right surround speaker (level trim)	RS → -30 - +30
right extra rear speaker (level trim)	RR → -30 - +30
left extra rear speaker (level trim)	LR → -30 - +30
left surround speaker (level trim)	LS → -30 - +30
sub-woofer (level trim)	SUB → -30 - +30

note

Some parameter options in the speaker setup routine are interrelated. For example, if NO is specified for a specific speaker, its setup options will be unavailable. Similarly, if NO sub-woofer is specified, only a default option will be available for the main left and right speakers.

note

The av2 user interface allows continuous scrolling through the speaker level setup stages.

note

The handset vol ▲ and vol ▼ keys must be used initially to set the overall volume when the test function is engaged.

four Exit setup mode.

Handset: press menu followed by mode ▲
Front panel: press and hold mode.



7.0 av2 inputs and interfaces

Note: The entire AV system should be switched off before connecting or disconnecting any inputs.

The **av2** has a total of ten audio inputs: six stereo analog and four digital. The analog inputs are connected through a combination of DIN and phono sockets while two digital inputs are connected through optical "TosLink" sockets and two through coaxial phono sockets. A remote control RC5 input is also fitted to enable remote control handset commands to be relayed to the **av2**. This feature provides enhanced multi-room or "concealed" installation flexibility. The RC5 input is selected during the Input Setup routine described in Section 9. Your dealer or local Naim Audio representative will be able to offer advice on its use.

Analog input sockets **ONE** and **TWO** are "versatile" sockets that can be combined to enable the connection of source components that already offer multi-channel outputs – DVD Audio and Super Audio CD for example. When operating in combined mode, eight or six input channels (available on the two DIN sockets) are routed internally direct to the output volume control, bypassing the internal signal decoding. Eight or six channel combined mode is selected during the Input Setup routine described in Section 9.

The input **THREE** socket also carries a stereo audio output signal. If the **av2** is to be integrated into a conventional stereo audio system this input/output socket should be connected either to the system's "tape monitor circuit" or in the case of a Naim system to the appropriate preamplifier, power supply or power amplifier input socket.

More! Integration of the av2 with a conventional stereo audio system may require a non-standard "reversed" connection cable. Your local Naim Audio representative or dealer will be able to offer advice.

Each input socket and its appropriate connection is detailed in the following table. See the illustration in Section 12 for socket and pin identification.

7.1 input connections

Input	Type	Socket	Connect
V11	Analog	5 pin DIN	Line-level stereo signal from source component. (Combined mode: Left main, Right main, Left surround, Right surround.)
V12	Analog	5 pin DIN	Line-level stereo signal from source component. (Combined mode: Centre, Sub-woofer, Extra rear left, Extra rear right.)
3	Analog	5 pin DIN	Line-level stereo signal from source component.
4	Analog	2 x phono	Line-level stereo signal from source component.
5	Analog	2 x phono	Line-level stereo signal from source component.
6	Analog	2 x phono	Line-level stereo signal from source component.
7	Digital	1 x phono	Digital audio source.
8	Digital	1 x phono	Digital audio source.
9	Digital	optical	Digital audio source.
10	Digital	optical	Digital audio source.
11	RC 5	phono	RC5 relay unit.

More! The 5 Pin DIN socket of Input 3 also carries stereo audio outputs. Input 3 should be used to connect the av2 to an existing Naim system.

More! The digital optical input sockets are fitted with protective plugs that must be removed before use.

8.0 av2 outputs and interfaces

The av2 is fitted with line-level signal output sockets for front left and right, centre, surround left and right, extra rear left and right and "sub-woofer" channels.

The front, centre, surround and extra rear outputs are connected through 4-pin DIN sockets and each of these should be routed to appropriate Naim power amplifiers. The sub-woofer output is connected through a single phono socket and should be connected to either an active sub-woofer or a mono power amplifier driving a passive sub-woofer. An alternative sub-woofer output is available on the centre output socket.

The av2 is also fitted with both analog and digital audio outputs. These outputs duplicate the selected input signal in either the analog or digital domain. No signal will be present on the analog output if a digital input is selected and similarly no signal will be present on the digital output if an analog input is selected. The analog outputs, connected via a pair of phono sockets, can be used to restore the amplifier tape monitor outputs if these have been used as a signal source for the av2. The digital output, available in both phono socket and optical TosLink formats, can be used to connect a digital audio recorder such as a CDR machine (if the digital data format is appropriate).

Interface connectors fitted to the av2 enable synchronised video signal switching, and integration with multi-room home entertainment systems. The video switch interface is connected via a "telecoms" style socket. This interface is intended specifically for the Naim vs1 Video Switcher. On-screen display (OSD) of av2 operational and setup commands will be available if the video switcher is used. The video switch interface socket should not be used for any other application. Inappropriate use may cause damage to the av2 or other equipment to which the socket is connected.

The multi-room interface socket is a 9-pin RS232 type connector. Multi-room interface functions of the av2 will depend upon the capabilities of the multi-room system and controller in use. Your dealer or local Naim Audio representative will be able to offer advice on both multi-room and OSD features.

Each output socket and its appropriate connection is detailed in the following table. See the illustration in Section 12 for socket and pin identification.

8.1 output and interface connections

Output	Type	Socket	Connect
1	Analog	2 x phono	Analog audio recording device (Tape).
2	Digital	optical	Digital audio recording device (CDR, MD, etc).
3	Digital	2 x phono	Digital audio recording device (CDR, MD, etc).
4	Analog	4 pin DIN	Power amplifier - Front left and right.
5	Analog	4 pin DIN	Power amplifier - Surround left and right.
6	Analog	4 pin DIN	Power amplifier - Centre (and alternative sub-woofer).
7	Analog	4 pin DIN	Power amplifier - Extra rear left & right.
8	Analog	1 x phono	Active sub-woofer.
9	Control	RJ45	Naim vs1 Video Switcher.
10	Control	RS232	Multi-room control.

More! On Screen Display (OSD) of the av2 front panel information will be available if a vs1 Video Switcher is connected to both the av2 and to an appropriate TV monitor. Use of OSD is covered in section 10.7.

More! The digital optical output socket is fitted with a protective plug that must be removed before use.

9.0 av2 detailed setup

Only once all the desired input and output connections are made should the **av2** setup procedure be initiated. Although the **av2** can be set up and controlled from its front panel, many parameters are best set from the primary listening and viewing position, so setup from the **narcom av** remote handset is recommended. It is important however that the **av2** front panel is visible during setup because its display provides feedback of control parameters. This is of less importance if a Video Switcher is connected as on-screen display of setup parameters will then be available.

More! Operation of the av2 from the front panel is shown in bracketed italics.

More! Flash remote handsets running Version 2 software can also be used to control the av2. For information on Flash software updates please contact your dealer or local Naim Audio representative.

When initially powered up from the switch on the rear panel the **av2** will, after a short delay as internal house-keeping is carried out, be in Standby mode. Standby is indicated by an illuminated Naim logo and a single dot indicator on the display. To wake the **av2** press and hold the **standby** key (*front panel: press and hold input or mode buttons*). The **av2** will wake-up in either the default state if it is previously unused, or in the state in which it was last shut-down.

There are two independent setup "pages"; each with a setup routine to be executed: **Input Setup** and **Speaker Setup**. Input Setup, which defines the type of source component connected to each input, should be carried out first. Speaker Setup enables various parameters and options for each speaker channel to be set.

More! Some speaker setup parameters are dependent on the selected av2 input so setup may be simplified if the av2 is initially returned to its setup defaults. To restore the default values separately in either setup "page" press and hold the handset disp key while the av2 is in the desired setup mode. The display flashes once to confirm.

To restore the default values simultaneously across both setup pages press and hold the handset disp key while the av2 is in normal mode. The mode button will flash, three bars appear in the display, and after a short delay the av2 will re-awake in input setup mode. The factory default settings are shown in Section 11.

More! The av2 will drop out of either setup mode after 5 minutes if no keys or buttons are operated.

More! It may help during setup to refer to the "quick setup" diagrams in Section 6.

9.1 setup routine - inputs

The first **av2** setup page and routine defines the type of source equipment connected to each input and enables a remote control input function to be selected. To switch the **av2** into **Input Setup** mode press the **menu** key followed by the **i/p ▲** key (*front panel: press and hold input button*).

The complete list of source component display options available is as follows: **DVD** (DVD video/audio), **LD** (laser disc), **TV** (television), **SAT** (satellite), **CAB** (cable service), **HDR** (hard disk recorder), **VCR** (video cassette), **GM** (game console), **PC** (personal computer), **PRE** (audio preamp), **CD** (compact disc), **CDR** (compact disc recorder), **TUN** (tuner), **DAB** (digital tuner), **MD** (mini disc), **DAT** (digital audio tape), **TAP** (audio tape) **AUX** (auxiliary), **DVA** (DVD audio) **SCD** (super audio compact disc).

The following order of setup steps is arbitrary. It is possible to move between setup steps by pressing **2 ▲** or **8 ▼** (*front panel: mode or input buttons*).

9.0 av2 detailed setup



define inputs

Step 1. The av2 display will show **VI1** on the left hand side and **6CH**, **8CH**, **---**, **AN1** or one of twenty possible source component types on the right hand side. **VI1** refers to Versatile Analog Input 1 and the right hand options to the type of source component connected to the input. **---** denotes an input set as unused. The **6CH** and **8CH** options re-configure the DIN socket input connectors 1 and 2 to offer a combined set of analog inputs routed direct to the av2 output volume control and output channels. Use the ◀4 or 6▶ keys (*front panel: rotate rotary control*) to select the option appropriate for the source component connected to the input(s). Move to the next step by pressing 8▼ (*front panel: mode button*).

More! If you wish not to specify a specific source component for any input, the right hand side of the display can either be left at its default setting, or be set to "unused" by selecting ---. Inputs set to --- will not appear for selection when in the av2 is used in operational mode.

More! Using inputs One and Two in combined mode enables the connection of source components that may already offer multi-channel outputs - DVD Audio and Super Audio CD for example. When operating in combined mode the input channels available on the two DIN sockets are routed, via the av2 output volume control, direct to the output connectors bypassing any internal signal decoding processing.

define inputs

Step 2. The av2 display will now show **VI2** on the left hand side and **AN2** or one of twenty possible source component types on the right hand side. **VI2** refers to Versatile Analog Input 2 and the right hand options to the type of source component connected to the input. Use the ◀4 or 6▶ keys (*front panel: rotate rotary control*) to select the option appropriate for the source component connected to the input. Move to the next step by pressing 8▼ (*front panel: mode button*).

More! If the 6CH or 8CH options have previously been selected for input VI1, input VI2 will not be available or displayed.

Step 3. The av2 display will now show **AN3** on the left hand side and one of eighteen possible source component types on the right hand side. **AN3** refers to Analog Input 3 and the right hand options to the type of source component connected to the input. Use the ◀4 or 6▶ (*front panel: rotate rotary control*) to select the option appropriate for the source component connected to the input. Move to the next step by pressing 8▼ (*front panel: mode button*).

Steps 4 to 10. Repeat the step 3 procedure for the remaining three analog inputs, the two optical digital inputs and the two coaxial digital inputs each time selecting the appropriate source component types using the ◀4 or 6▶ keys (*front panel: rotate rotary control*). It is always possible to return to and adjust the previous input by pressing 2▲ (*front panel: input button*). Move to the next step by pressing 8▼ (*front panel: mode button*).

IR option

Step 11. The av2 display will now show **EXT** on the left hand side and either **RC5** or **DAT** on the right hand side. **EXT** refers to the external control input socket and **RC5** or **DAT** to its state. When selected to **RC5**, the IR remote control is operational. This parameter must be set to **DAT** for the multi-room/RS232 data interface to operate. Use the ◀4 or 6▶ keys (*front panel: rotate rotary control*) to select either option.

More! Contact Naim Audio directly for a full list of RS232 control codes.

More! With DAT (data) selected, Remote Handset control is disabled. It can be re-enabled using the front panel controls.

9.0 av2 detailed setup

Pro Logic II options

Steps 12 to 14 of the Input Setup routine enable the adjustment of three parameters dedicated to Dolby Surround Pro Logic II encoded programme material. These parameters need not be changed from their default settings during Input Setup but may be adjusted as required when appropriate programme material is used. In addition to their position as the last three Input Setup parameters, they can also be more readily accessed by entering Input Setup mode and pressing the handset **2** **▲** key (*front panel: input button*).

More! See Section 10.2 - 10.6 for further information on decode options and principles.

Step 12. The av2 display will now show **PAN** on the left hand side and **OFF** or **ON** on the right hand side. **PAN** refers to Dolby Surround Pro Logic II "Panorama" and when **ON** is selected a proportion of the front stereo signal is fed to the surround channels. Use the **◀ 4** or **6 ▶** keys (*front panel: rotary control*) to select an option. Move to the next step by pressing **8 ▼** (*front panel: mode button*).

Step 13. The av2 display will now show **W** on the left hand side and a numerical value on the right hand side. **W** refers to Dolby Surround Pro Logic II "Centre Width" and the numerical value to the strength of the centre channel in relation to the front left and right channels. Selection of a higher value increases the relative strength of the left and right channels. Use the **◀ 4** or **6 ▶** keys (*front panel: rotary control*) to select a numerical value. Move to the next step by pressing **8 ▼** (*front panel: mode button*).

Step 14. The av2 display will now show **D** on the left hand side and a numerical value on the right hand side. **D** refers to Dolby Surround Pro Logic II "Dimension" and the numerical value to the balance between the front and surround channels. Selection of a higher value increases the relative strength of the surround channels. Use the **◀ 4** or **6 ▶** keys (*front panel: rotary control*) to select a numerical value. Move to the next step by pressing **8 ▼** (*front panel: mode button*).

Step 14 completes the av2 Input Setup routine. To exit from Input Setup mode press the **menu** key followed by the **i/p ▲** key (*front panel: press and hold input button*). Exiting from setup mode stores the settings selected for each parameter.

9.2 setup routine – speakers

nominate speakers

The Speaker Setup routine defines the presence and size of the speakers connected to the main, centre, surround, extra rear and sub-woofer outputs, their distance from the listening position, and allows their relative volumes to be adjusted. To switch the av2 into Speaker Setup mode press the **menu** key followed by the **mode ▲** key (*front panel: press and hold mode button*).

*More! Some parameter options in the speaker setup routine are interrelated. For example, if **NO** is specified for a specific speaker its setup options will be unavailable. Similarly if **NO** sub-woofer is specified only a default option will be available for the main left and right speakers.*

The following order of setup steps is arbitrary. It is possible to move between setup steps by pressing **2 ▲** or **8 ▼** (*front panel: input or mode buttons*).

Step 1. The **mode** button indicator on the av2 front panel will flash, the display will show **LR** on the left hand side and **LG** or **SM** on the right hand side. **LR** refers to the main left and right channel speakers and **LG** (large), **SM** (small) to their size. Pressing either the **◀ 4** or **6 ▶** keys (*front panel: rotary control*) will prompt the right hand side of the display to cycle through the **SM** and **LG** options. Select either option and move to the next step by pressing **8 ▼** (*front panel: mode button*).

*More! If the av2 is being set up from its default state, the main left and right speaker options will be limited to **LG** (large) until a sub-woofer has been specified as present.*

9.0 av2 detailed setup

av2

nominate speakers

More! Large speakers are typically floor or stand mounted products with bass drivers of at least 130mm (5 inches) diameter. "Small" speakers are typically those that are primarily intended to be used as part of a sub-woofer/satellite system. If LG (large) is selected, only low frequency effect signals are routed to the sub-woofer channel. If SM (small) is selected, both the low frequency effects and the main channel low bass signals are routed to the sub-woofer.

Step 2. The av2 display will now show **CEN** on the left hand side and either **NO**, **SM** or **LG** on the right hand side. **CEN** refers to the centre channel speaker. Use the ◀ 4 or 6 ▶ keys (front panel: rotary control) to select **NO** (none), **SM** or **LG**. Move to the next step by pressing 8 ▼ (front panel: mode button).

More! A "large" centre channel speaker would typically incorporate bass driver or drivers of at least 130mm (5 inches) diameter. "Small" speakers are typically those that are primarily intended to be used as part of a sub-woofer/satellite system. Selecting SM (small) routes the centre channel bass signal to the main left and right speakers or sub-woofer. Selecting NO (none) routes the centre channel signal equally to the main left and right speakers.

Step 3. The av2 display will now show **SUR** on the left hand side and again either **NO**, **SM** or **LG** on the right hand side. **SUR** refers to the left and right surround channel speakers. Use the ◀ 4 or 6 ▶ keys (front panel: rotary control) to select **NO**, **SM** or **LG**. Move to the next step by pressing 8 ▼ (front panel: mode button).

More! A "large" surround channel speaker would typically incorporate bass driver or drivers of at least 130mm (5 inches) diameter. "Small" speakers are typically those that are primarily intended to be used as part of a sub-woofer/satellite system. Selecting SM (small) routes the surround channel bass signal to the main left and right speakers. Selecting NO (none) routes the surround channel signal to the main left and right speakers.

Step 4. The av2 display will now show **ER** on the left hand side and again either **NO**, **1SM**, **1LG**, **2SM** or **2LG** on the right hand side. **ER** refers to extra rear left and right speakers and **NO** (none), **1SM** (one small), **1LG** (one large), **2SM** (two small) or **2LG** (two large) to their presence, size and number. Use the ◀ 4 or 6 ▶ keys (front panel: rotary control) to select an option. Move to the next step by pressing 8 ▼ (front panel: mode button).

More! The facilities for "extra" rear channels on the av2 ensures compatibility with programme material encoded for seven full bandwidth channels and one sub-woofer channel. The definition for "small" and "large" speakers is the same as for surround speakers.

Step 5. The av2 display will now show **SUB** on the left hand side and either **NO** or **YES** on the right hand side. **SUB** refers to the sub-woofer and **NO** or **YES** to its presence or absence. Use the ◀ 4 or 6 ▶ keys (front panel: rotary control) to select an option. Move to the next step by pressing 8 ▼ (front panel: mode button).

Steps 6 to 14 of the Speaker Setup routine define the distance from the primary listening and viewing position to the speakers. Defining the distances is important because it enables the av2 to apply appropriate time delays to each of the channels. The distances need not be measured accurately. Plus or minus 150 mm (6 inches) is adequate. The first of these steps switches the av2 measurement units between feet and metres.

Step 6. The av2 display will now show **UNT** on the left hand side and **FT** or **M** on the right hand side. **FT** refers to distance measurement in feet and **M** to measurement in metres. Use the ◀ 4 or 6 ▶ keys (front panel: rotary control) to select your preferred option. Move to the next step by pressing 8 ▼ (front panel: mode button).

Step 7. The av2 display will now show **L** on the left hand side and a numerical distance value on the right hand side. **L** refers to the left main speaker and the numerical value its

nominate speakers

set speaker distance

9.0 av2 detailed setup

set speaker distance

distance from the primary listening and viewing position. Use the ◀ 4 or 6 ▶ keys (*front panel: rotary control*) to select a numerical value. Move to the next step by pressing 8 ▼ (*front panel: mode button*).

Steps 8 to 14. Repeat the step 7 procedure for the Centre (CEN), Main Right (R), Right Surround (RS), Right Extra Rear (RR), Left Extra Rear (LR), Left Surround (LS) and Sub-woofer (SUB) channels each time selecting the appropriate distance value with the ◀ 4 or 6 ▶ keys (*front panel: rotary control*). Move to the next step by pressing 8 ▼ (*front panel: mode button*).

More! Defining the distance from the speakers to the listening/viewing position adjusts only relative signal time delays and not volume levels.

More! The centre speaker should not be further away from the listening position than either main speaker.

More! If specific speakers have been previously defined as not present their distance parameter will be unavailable.

Steps 15 to 23 of the Speaker Setup routine define relative volume levels of the channels. Step 15 selects and activates a test "noise" signal that enables the relative volume levels to be adjusted by ear. Ensure that the av2 is connected to the required power amplifiers and sub-woofer, that these are switched on and that the speakers are correctly connected.

speaker test

Step 15. The av2 display will show TST on the left hand side and either OFF or ON on the right hand side. Pressing either the ◀ 4 or 6 ▶ keys (*front panel: rotary control*) will prompt the right hand side of the display to cycle through OFF and ON. Select ON and move to the next step by pressing 8 ▼ (*front panel: mode button*).

More! If the test signal is either too loud or too quiet the volume can be adjusted with the vol up and down keys.

More! When using the test noise to adjust the volume level for each speaker there are some issues that need to be considered if the dynamic range of the av2 is to be optimised.

Note that the adjustment levels are relative values only and do not have any effect on the loudness of the system for a given av2 volume setting. For example, if all the speaker channels had a setting of, say, -12 or if they all had a setting of, say, +6 the resulting loudness of the av system would be the same at any given setting of the master volume control.

Following the procedures below will help ensure optimised dynamic range from the av2.

When using an active sub-woofer the adjustment level for the sub-woofer output on the av2 should be set somewhere between the maximum and minimum settings needed for the other loudspeakers in the system. Subsequently the volume control on the sub-woofer itself should be adjusted to give the best results.

There is a similar requirement when setting the main left and right speaker levels if the av2 is integrated into a conventional stereo system. The volume control on the stereo preamplifier should be set to an easily recalled position such that the adjustment levels for the main left and right outputs of the av2 are set somewhere between the maximum and minimum settings needed for the other loudspeakers. The volume control setting on the preamplifier will have to be set every time the av system is used; not forgetting to reset it for use with music. For Naim nac 72, 102, 82 and 52 preamplifiers used with an av2 the preamplifier volume control should be set to around 12 o'clock. The Naim nait 5 integrated amplifier and nac 112 preamplifier have automatic gain adjustment that takes effect when the av input is selected, and so the volume control does not have to be altered.

speaker level adjustment

9.0 av2 detailed setup



speaker level adjustment

Step 16. Use the handset vol ▲ and vol ▼ keys initially to set a suitable volume. The test signal should be heard through the Main Left speaker. The av2 display will show L on the left hand side and a numerical value between -30 and +30 on the right hand side. L refers to the Main Left speaker and the numerical value its relative volume level. Use the ◀ 4 or 6 ▶ keys (*front panel: rotary control*) to select volume level initially of around zero. Move to the next step by pressing 8 ▼ (*front panel: mode button*).

More! If the test signal is not heard through the left main speaker the av2, power amplifiers or speakers are not connected or set up correctly.

Steps 17 to 23. Repeat the step 16 procedure for the Centre (CEN), Main Right (R), Right Surround (RS), Right Extra Rear (RR), Left Extra Rear (LR), Left Surround (LS) and Sub-woofer (SUB) channels each time adjusting the volume using the ◀ 4 or 6 ▶ keys (*front panel: rotary control*) to be similar to the previous speaker. It is always possible to return to and adjust the previous speaker by pressing 2 ▲ (*front panel: input button*).

More! It may be helpful to cycle once or twice through all the speakers before making any level adjustments.

More! If specific speakers have been previously defined as not present they will not be included in the test.

More! If the test signal is not heard through the speaker designated in the left hand side of the display at each stage, the av2, power amplifiers or speakers are not connected or setup correctly.

More! Take care when exiting speaker setup mode that adjustment of the test signal has not left the overall volume set at an excessive level.

setup done

Step 23 completes the av2 Speaker Setup routine. To exit from Speaker Setup mode press the menu key followed by the mode ▲ key (*front panel: press and hold mode button*). Exiting from setup mode stores the settings selected for each parameter.

10.0 av2 operation

With appropriate inputs and outputs connected, and both Speaker and Input Setup routines complete, the av2 is ready for use. If a setup parameter needs adjustment the setup pages are always available from the remote handset or front panel as described in Section 9. Remember however that some speaker setup parameters are subordinate to the selected input and decode selection. For example, if an analog input and stereo direct mode are chosen, only the main left and right speaker parameters will be available for adjustment.

10.1 input selection and volume control

To select an input use the **input** key followed by one of the numeric keypad numbers 1 to 0 (*front panel: input button*). The keypad numbers correspond to the input socket numbers. The handset **i/p**▲ and **i/p**▼ can also be used to scroll through the inputs. When a new input is selected the av2 display will sequentially show the input source (previously specified in the Input Setup page) and the current decode mode settings. The default display data is overall volume.

More! The av2 may take a moment to display inputs and decode modes when new inputs are selected as it locks on to, and identifies, any signals. During this time the display will show three flashing bars.

To adjust the overall volume use the **vol**▲ or **vol**▼ keys (*front panel: rotary control*).

10.2 decode modes – selection and availability

The signal decoding behaviour and options of the av2 are dependent on both the source programme material and in some cases the speaker setup previously specified. With analog, and some digital programme material, decoding options are user definable – although the results of processing for example, music material with movie decoding mode are unpredictable. In some cases however the av2 will automatically identify encoded material and only make available the appropriate decoding option or options. The av2 display and decode indicators together show each decoding mode selected or imposed.

To select a decoding mode use the **mode** key (*front panel: mode button*) followed by one of the numeric keypad numbers. The keypad numbers correspond to decoding modes with lower numbers selecting less complex modes (keypad 0 generally selects **direct** or **auto** modes, keypad 1 selects **mono**, keypad 2 selects **stereo**, etc) The handset **mode**▲ and **mode**▼ can also be used to scroll through the available decode modes. The selected decode option will flash in the display until the av2 has successfully “locked” to the signal before the display reverts back to indicating volume. The av2 will store the last selected decode mode for each type of signal and for each input. The decoding options and display for each type of programme material, and the speaker channel schemes for each are detailed in tables 10.4 and 10.5.

10.3 channel schemes and speakers

Channel schemes describe the speakers employed by each decode mode. They are expressed by terms such as “5.1” or “3/2.1” Taking 5.1 as an example, the “5” refers to the number of conventional speaker channels and the “.1” refers to a sub-woofer. In 3/2.1 the “3” refers to the number of front channels employed (in this case, left, right and centre), the “2” refers to the number of surround channels and the “.1” refers to a sub-woofer. With appropriately encoded digital programme material channel schemes are displayed by the av2 when decode modes and inputs are selected (if a signal is present).

10.0 av2 operation

10.4 decode table – selection, availability and display

Decode Mode	Programme Material						
	Analog	Stereo PCM (digital)	Dolby Digital (2/0)	Dolby Digital (3/2.1)	DTS (3/2.1)	DTS-ES Discrete	DTS-ES Matrix
Direct	DIRECT						
Mono	MONO	MONO	MONO	MONO	MONO	MONO	MONO
Stereo	STEREO	STEREO	STEREO	STEREO	STEREO	STEREO	STEREO
Dolby PL II Music	MUSIC	MUSIC	MUSIC				
Dolby PL II Movie	MOVIE	MOVIE	MOVIE				
Dolby Digital Surround EX				EX			
DTS Neo:6 Cinema	NEO:6C	NEO:6C	NEO:6C				
DTS Neo:6 Music	NEO:6M	NEO:6M	NEO:6M				
DTS Neo:6					NEO:6		
Auto		AUTO	AUTO	AUTO	AUTO	AUTO	AUTO
		2/0	3/2.1	3/2.1		ES-DISC	ES-MTRX

More! The "direct" option available to analog inputs routes the signal directly to the output volume control, switching off and bypassing any signal decoding. This is distinct from the "stereo" decode option which digitises the incoming signal and uses internal processing to control speaker channel routing.

More! Most decoding options and choices are self evident - a Dolby Surround encoded movie signal (either digital or analog) should ideally be decoded in Dolby Pro Logic Movie II mode for example.

More! DTS Neo:6, DTS-ES, and DTS Matrix can only be selected if extra rear speakers are specified. If no such speakers are present then DTS-ES Discrete encoded material will be decoded as DTS 3/2.1.

More! The channel scheme displayed by the av2 for auto decoding of digital material may depend on the specific scheme encoded within the material. Schemes other than those shown in the table above are possible.

More! Dolby Pro Logic and DTS Neo:6 decoding can be applied to conventional analog or digital stereo audio (CD for example). Results however will be variable because effects, centre or sub-woofer information is not usually encoded in conventional stereo programme material in the first place. Conversely, DTS, Dolby Surround or Dolby Digital Surround programme material decoded to conventional stereo or mono will reproduce satisfactorily without significant loss of programme information.

More! The continual development of decoding technologies means that your av2 may offer and display some further or alternative decode options. If this appears to be the case please visit www.naim-audio.com and download the latest av2 manual.



10.0 av2 operation

10.5 decode modes and channel schemes

Decode Mode	Maximum Speaker Channels						
	Left Front	Centre	Right Front	Left Surround	Right Surround	Extra Rear	Sub-Woofer
Direct	●		●				
Mono		●					
Stereo	●		●				
Dolby PL II Music	●	●	●	●	●		●
Dolby PL II Movie	●	●	●	●	●		●
Dolby Digital Surround EX	●	●	●	●	●	●	●
DTS Neo:6 Cinema	●	●	●	●	●	●	●
DTS Neo:6 Music	●	●	●	●	●	●	●
DTS Neo:6	●	●	●	●	●	●	●
Auto	●	●	●	●	●	●	●

10.6 surround encoding background and technology

Feature films have carried the multi-channel sound tracks necessary for "surround sound" in some cases since the 1950s. But only since the mid 80's have the benefits of surround sound been available to domestic "home theatre" consumers. The technology that first enabled four channels of audio to be decoded from the stereo soundtrack of consumer media such as video cassette is Dolby Surround Pro Logic. Since Dolby Surround Pro Logic, and especially following the introduction of digital audio-visual products such as DVD, enhanced encode and decode technologies have been introduced that enable a greater number of higher quality channels of audio to be encoded. With digital encoding techniques such as Dolby Digital and DTS Surround, appropriately encoded feature films, music and even computer games can be reproduced in full-bandwidth surround sound with up to seven audio channels (left, right, centre, surround left, surround right, surround extra, low-frequency effects).

The following few paragraphs provide a short description and explanation of each decode technology and mode available on the av2. Further technical information can be found at www.dolby.com and www.dtsonline.com

Dolby Surround Pro Logic

Dolby Surround Pro Logic is a matrix decoding process that generates four output signals (left, right, centre, surround) from a Dolby Surround encoded analog stereo input signal. It is built into virtually every home theatre audio system. The nature of Pro Logic decoding constrains the single surround channel to relatively narrow bandwidth.

Dolby Surround Pro Logic II

Dolby Surround Pro Logic II is an improved analog matrix decoding technology that provides improved surround performance on Dolby Surround encoded program material. While earlier surround programme material is fully compatible with Pro Logic II, appropriately encoded soundtracks can take full advantage of its enhancements - which include separate full bandwidth left and right surround channels. Pro Logic II also features two distinct decoding options for "music" and "movie" programme material.



10.0 av2 operation



Dolby Digital

Dolby Digital is a fully digital decoding technology that provides three full bandwidth front channels, two full bandwidth surround channels, and one low-frequency effects channel - a channel scheme known generically as "3/2.1" (or "5.1"). The encoding technique for Dolby Digital, known as Dolby AC-3, has since 1995 been used on many Video Laser Discs and more recently on DVD. Dolby AC-3 encoding can also be found on digital television services. In addition to encoding audio for six channel replay, Dolby AC-3 incorporates compression techniques that ease audio data storage and transmission demands and can enable, for example, a single DVD to carry a complete movie.

Dolby Digital 2/0

A variation of Dolby Digital 3/2.1 is Dolby Digital 2/0. Dolby Digital 2/0 takes advantage of Dolby AC-3 data compression in order to reduce the data storage demands of stereo programme material. The "2/0" denotes the use of just two main audio channels with no low frequency effects channel. Programme material encoded for a "2.1" (two main channels with one sub-woofer channel) channel scheme is also available and can be handled within Dolby 2/0 decoding.

Dolby Digital Surround EX

The Dolby Digital Surround EX theatre system was co-developed by Dolby Laboratories and Lucasfilm THX, and was first used theatrically for the movie Star Wars: Episode I: The Phantom Menace in 1999. The system uses 5.1-channel Dolby Digital encoding but delivers an additional surround channel by mixing its signal into the left surround and right surround channels using matrix encoding. This additional channel is matrix decoded upon playback and routed to one or more centre rear speaker. Listeners with regular 5.1 channel Dolby Digital systems do not lose the extra surround channel information; it is simply reproduced by the left surround and right surround channels.

DTS Surround

DTS Surround is an alternative digital audio encoding format that has become popular with feature film producers and can therefore be found on many DVDs. The first feature film to be DTS encoded was Jurassic Park in 1993. DTS Surround provides a similar 3/2.1 channel scheme to Dolby Digital with the encoding technology also providing data compression. The DTS data compression ratio is lower than that in AC-3 however and it is argued that DTS can provide better audio quality. The downside of any quality improvement over AC-3 is however higher data storage requirements.

DTS-ES Matrix

DTS-ES (Extended Surround) Matrix is an enhancement of DTS Surround where a seventh channel is matrix encoded into the left and right surround channels (matrix encoding is the class of technology used in Dolby Surround Pro Logic). DTS-ES Matrix provides a 6.1 channel scheme with the extra channel used to reproduce effects located directly behind the listener.

DTS-ES Discrete 6.1

DTS-ES Discrete 6.1 differs from ES Matrix in providing a fully independent seventh audio channel rather than it being matrix encoded into two existing channels. This enhancement provides opportunities for producers and engineers to generate surround effects that would not be otherwise possible.

DTS Neo:6

DTS Neo:6 provides a decoding technique that enables legacy analog or digital stereo programme material to take advantage of contemporary decoding technology and 6.1 channel schemes. Material matrix encoded for four surround channels, or even un-encoded stereo material can be processed by the DTS Neo:6 decoder to generate 3 main channels, 3 surround channels. The low-frequency channel is generated by down-stream filtering.

10.0 av2 operation

10.7 on-screen display

If a Naim vs1 Video Switcher is used with the av2, on screen display (OSD) of command and status information is available if a suitable video monitor is used. OSD fundamentally repeats the information shown on the av2 display although the extra space available enables more comprehensive information to be shown. To select OSD press the remote handset menu key. The av2 display will show OSD. The remote handset osd key can then be used to display temporary on-screen information. Navigation around the on screen display is provided by the handset 2 ▲, 8 ▼, 4 ◀ and 6 ▶ keys, and select and exit provided by the enter and clear keys. Control of the av2 via OSD is not accessible from the front panel (although it can still be controlled conventionally from the front panel).

More! Pressing the osd key will also cause the av2 display to scroll through the current state of each accessory option.

10.8 accessory functions

The av2 has six accessory functions accessible at all times from the remote handset. The av2 display or on screen display will temporarily indicate selection or de-selection of these functions.

Cinema EQ: Cinema EQ provides compensation for the over-emphasised high frequency sound of some cinema soundtracks. It is selected or disabled by pressing the menu key followed by the 2 key.

Bass Mix: The Bass Mix option routes sub-woofer channel information additionally to the main left and right loudspeakers. It is selected or disabled by pressing the menu key followed by the 1 key. Bass Mix will have no effect if "small" main left and right speakers are specified.

Mute: The mute key immediately reduces the volume to zero. A second operation of the mute key restores the volume to its previous level.

More! The volume can also be restored after a mute command by turning the front panel volume control to zero and then up to a normal listening level.

Display: The disp key switches the av2 display off. When switched off the display will temporarily flash information when changes are made. A second press of the disp key will restore the display.

More! The disp key is also used to restore av2 setup defaults. See Section 11.

Midnight: The midn key compresses the signal and reduces the bass content. It can help reduce disturbance to others from late night listening.

More! Midnight is only available with Dolby Digital programme material.

Standby: The standby key returns the av2 to standby mode. The Naim logo will remain illuminated and the display will show a single dot.

10.0 av2 operation

10.9 narcom av handset

The narcom av is a dedicated remote handset for the av2. It is not compatible with other naim audio products.

input, mode
Switches numeric keys between input and decode mode selection.

i/p ▲ , mode ▲
i/p ▼ , mode ▼
Used to access setup pages and to scroll up and down through inputs and decode modes.

enter, clear, menu, osd
Used in On Screen Display control. menu also used to access setup modes.

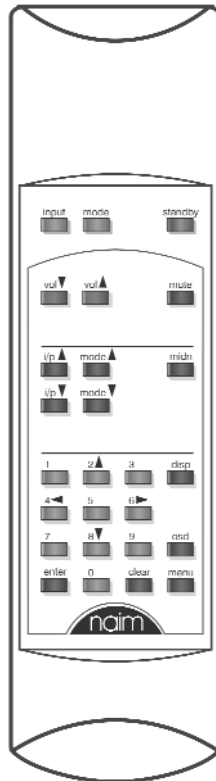

standby
Switches av2 into and from standby.

mute
Silences and restores audio output.

midn
Selects midnight function. See Section 10.8.

disp
Switches display on and off. Also resets setup defaults.

numeric keys
Used to select inputs and decode modes. Also used to select setup values.

More! In isolated cases it is possible for remote handset commands for one piece of equipment to interfere with the operation of another. If this should occur with any Naim Audio handset please contact your dealer for advice.

av2

11.0 av2 setup defaults

11.1 setup defaults

The factory default values for each setup parameter are shown below.

input defaults

V11	→	AN1
V12	→	AN2
AN3	→	AN3
AN4	→	AN4
AN5	→	AN5
AN6	→	AN6
OP1	→	OP1
OP2	→	OP2
CO1	→	CO1
CO2	→	CO2
EXT	→	RCS
PAN	→	OFF
W	→	0
D	→	0

restoring defaults

When first woken from standby, an av2 will hold either the default setup values or those that were in use when it was last shut-down. If the av2 is to be set up for a new installation, and may have been previously used, the setup values should be returned to their factory defaults.

To restore the default values separately in either setup page press and hold the handset disp key while the av2 is in the desired setup mode. The display flashes once to confirm.

To restore the default values simultaneously across both setup pages press and hold the handset disp key while the av2 is in normal mode. The mode button flashes, three bars appear in the display, and after a short delay the av2 will re-awake in input setup mode.

speaker defaults

LR	→	LG
CEN	→	NO
SUR	→	NO
ER	→	NO
SUB	→	NO
UNT	→	M
L	→	0
CEN	→	0
R	→	0
RS	→	0
RR	→	0
LR	→	0
LS	→	0
SUB	→	0
TST	→	OFF
L	→	0
CEN	→	0
R	→	0
RS	→	0
RR	→	0
LR	→	0
LS	→	0
SUB	→	0

12.0 av2 connection diagrams

12.1 front



12.2 rear

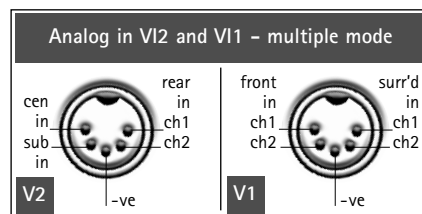
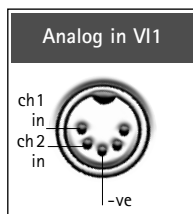
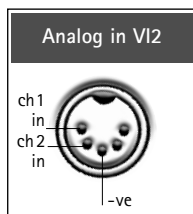
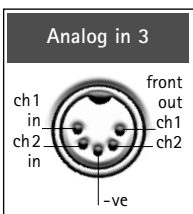
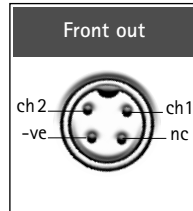
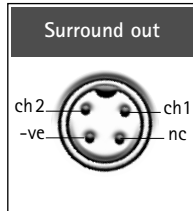
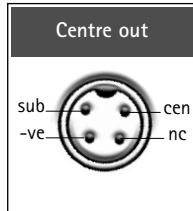
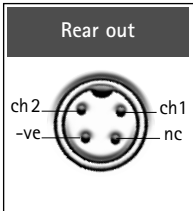
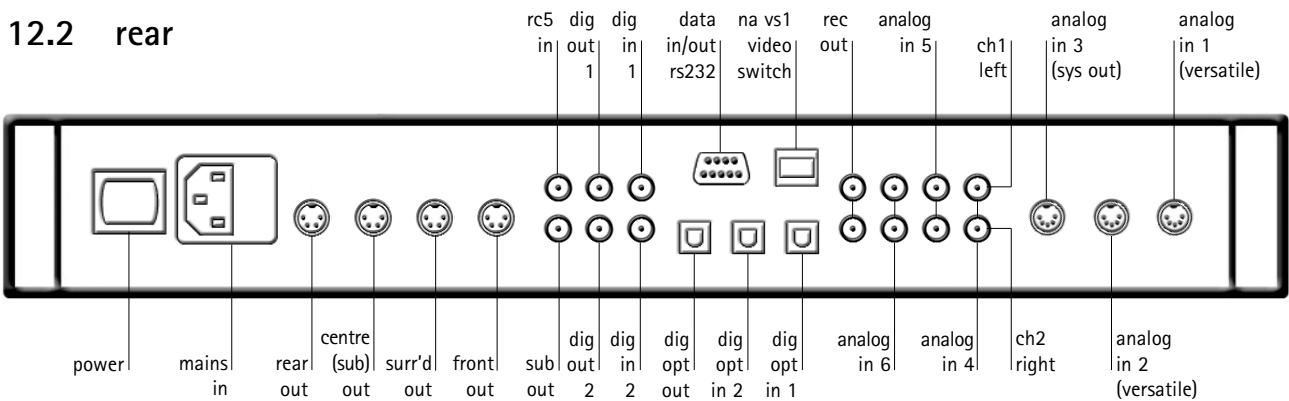

Specifications

av2

Inputs	Six stereo analog, two coaxial digital, two optical digital
Outputs	Main left and right, surround left and right, centre, extra rear left and right, sub-woofer. Two coaxial digital, one optical digital
Decode Modes	Mono, Stereo, Dolby Pro Logic II, Dolby Digital, Dolby Digital Surround EX, DTS Surround and Neo:6
Mains supply	100V. 115V. 230V - 50/60Hz
Case size (H x W x D)	70 x 432 x 301mm

12.0 av2 connection diagrams

12.3 av2 connected to nap v175 and nap 150 (stand alone audio-visual system)

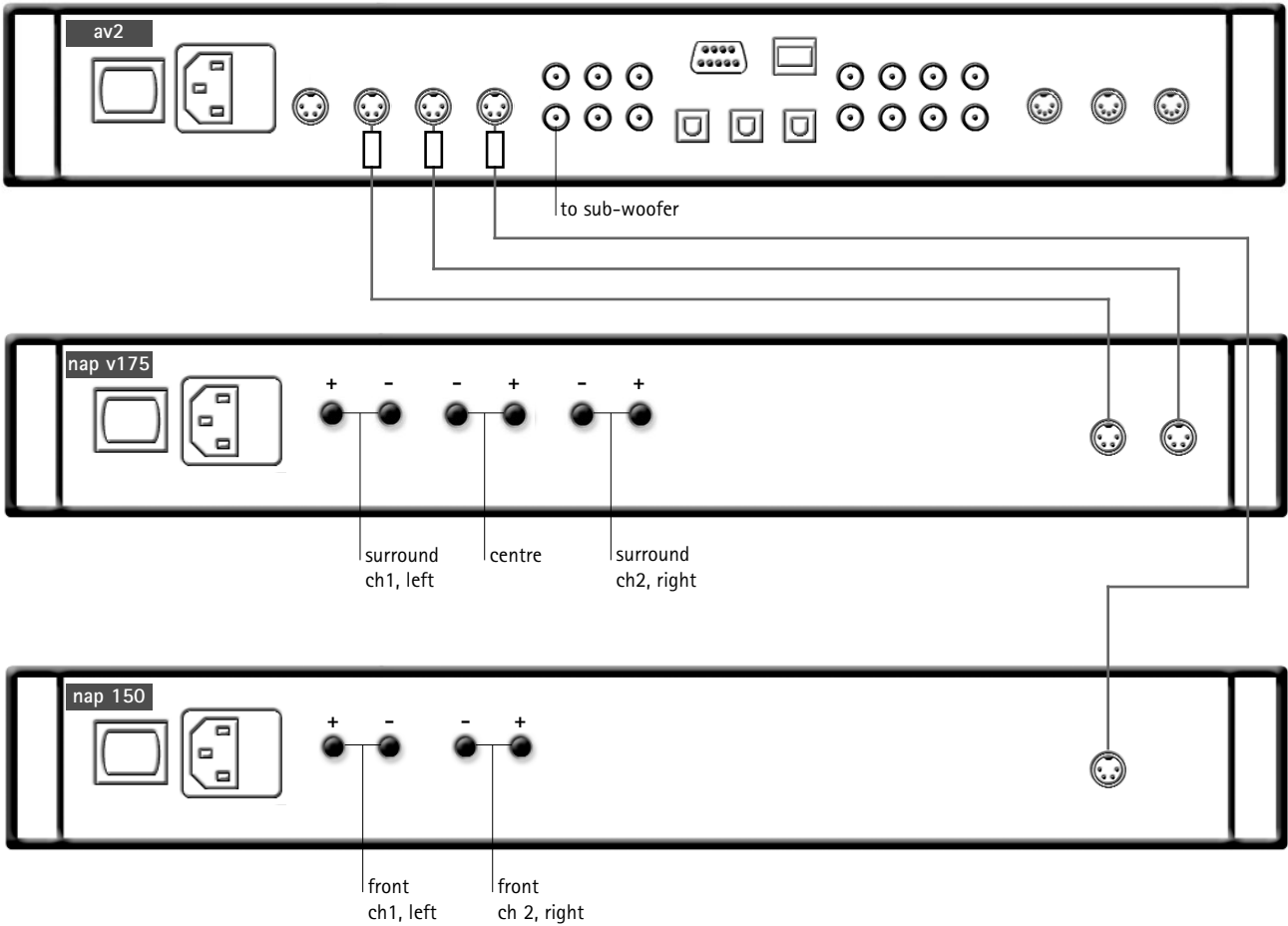

note

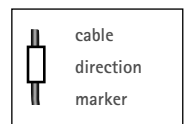

The av2 features various technologies to reduce microphonic effects, in particular a compliant mounting for the main circuit boards and the DIN sockets on the rear. Some movement of the board and sockets when connecting/disconnecting is normal.

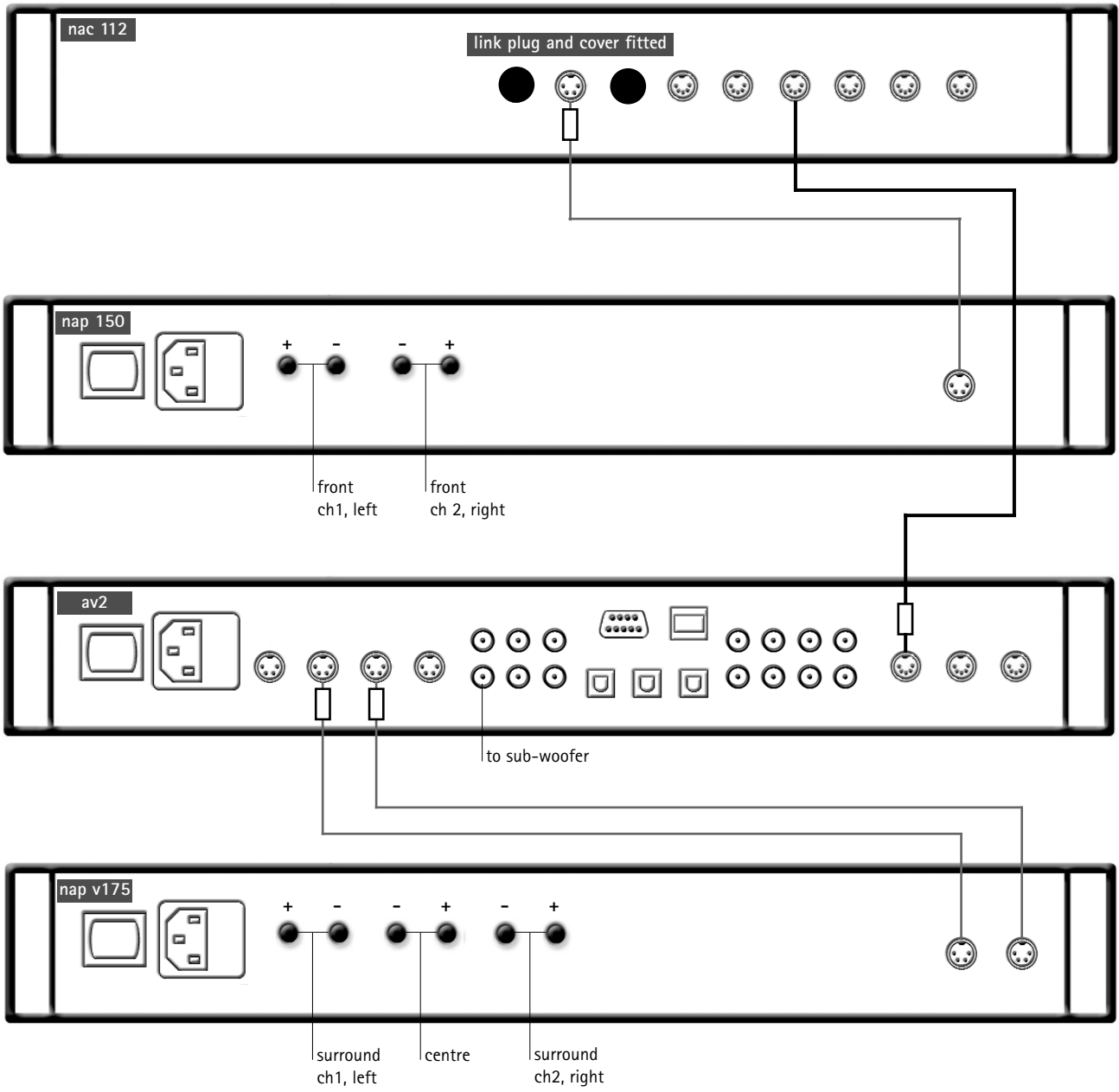

12.0 av2 connection diagrams

12.4 nac 112/150 connected to av2 and nap v175 (two channel system with audio-visual added)



	cable direction marker
Interconnect Cables	
	4 to 4 pin DIN 
	reverse 5 to 5 pin DIN 

13.0 nap v175 installation and operation

13.1 connections

The nap v175 is a three channel power amplifier intended for use in audio-visual home-theatre systems. The three channels provide audio power to drive a centre channel speaker and a pair of either main front or surround channel speakers. Audio line level input is via two 4-pin DIN sockets - one for the centre channel and one for the main or surround pair.

The negative input and output connections within each zone are common but there is no signal negative connection between them. The mains earth grounds only the case and the electrostatic screen within the transformer and is not connected to the signal negative. The mains earth must always be connected to "ground" regardless of any other equipment used. In order to avoid hum-loops the signal negative of the whole system should be connected to the mains earth in one place. This should be the primary signal source.

13.2 operation and protection

Once installed the nap v175 is intended to remain permanently powered up via its rear panel switch. If the internal heatsink reaches 70°C due to prolonged running at very high dissipation the mains supply will be interrupted and the indicator light will go off until the amplifier has cooled down. This may take up to thirty minutes.

13.3 loudspeaker cable and connectors

Naim Audio speaker cable should be used to connect a loudspeaker to the output of the nap v175. Special Naim Audio loudspeaker connectors are supplied to make the connection to the power amplifier(s). **IT IS ESSENTIAL THAT THESE ARE USED, IN ORDER TO COMPLY WITH CURRENT SAFETY REGULATIONS.**

DO NOT, FOR ANY REASON, USE SO CALLED HIGH DEFINITION WIRE OR ANY OTHER SPECIAL CABLE BETWEEN POWER AMPLIFIER AND LOUDSPEAKER AS DAMAGE MAY RESULT.

14.0 nap v175 connection diagram

14.1 rear

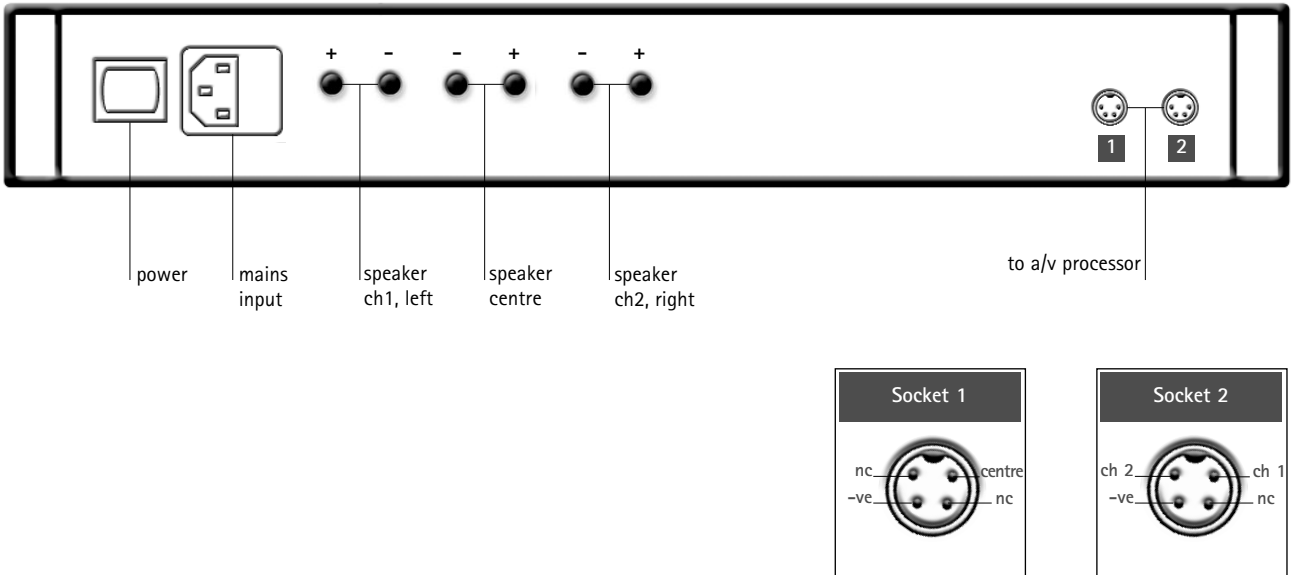

Specifications

nap v175

Power output

Continuous, 8 ohms

50 watts per channel

Channels

Three

Voltage gain

+29dB

Frequency response

-3dB @ 3Hz & 50kHz

Input impedance

18 kilohms

Mains supply

100V, 115V, 230V - 50/60Hz

Case size (H x W x D)

70 x 432 x 301mm

ec declaration of conformity to appropriate standards

Manufacturer

Naim Audio Limited, Southampton Road, Salisbury, England, SP1 2LN

Products

na av2, nap v175

Safety

HD 195-S6
EN 60 065

EMC

Emissions Tested to EN 55013
Sound and television broadcast receivers and associated equipment

Immunity Tested to EN55020
Electromagnetic immunity of broadcast receivers and associated equipment

In accordance with CISPR 16-1
Radio disturbance and immunity measuring apparatus

CISPR 16-2
Methods of measurement of disturbances and immunity

IEC 801-2 8KV (air gap)
4KV (contact)
(performance criterion B)

IEC 801-3 3V/m 20dB
(performance criterion A)

IEC 801-4 1KV (AC lines)
0.5KV (signal lines)
(performance criterion B)

av2 licence notes

Manufactured under licence from Dolby Laboratories.

"Dolby", "Pro Logic", "Surround EX" and the double-D symbol are trademarks of Dolby Laboratories. Confidential unpublished works. Copyright 1992-1997 Dolby Laboratories. All rights reserved.

DTS Digital Surround™ is a discrete 5.1 channel digital audio format available on CD, LD and DVD software which consequently cannot be decoded and played back inside most CD, LD and DVD players. For this reason, when DTS-encoded software is played back through the analog outputs of the CD, LD or DVD players, excessive noise will be exhibited. To avoid possible damage to the audio system, proper precautions should be taken by the consumer if the analog outputs are connected directly to an amplification system. To enjoy DTS Digital Surround™ playback, an external 5.1 channel DTS Digital Surround™ decoder such as the Naim Audio av2 must be connected to the digital output (S/PDIF, AES.EBU or TosLink) of the CD, LD or DVD player.

"DTS", "DTS-ES Extended Surround" and "Neo:6" are trademarks of Digital Theater Systems Inc.